

*idronics*TM

CALEFFI
Hydronic Solutions

26

January 2020

JOURNAL OF DESIGN INNOVATION FOR HYDRONIC AND PLUMBING PROFESSIONALS

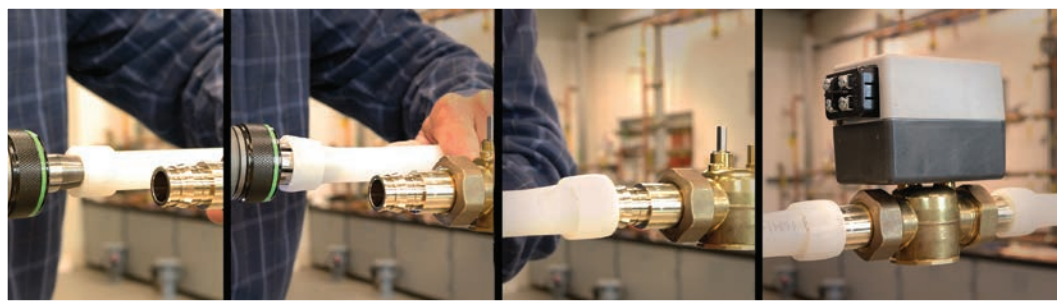

**Pipe Joining for Plumbing
and Heating Systems**

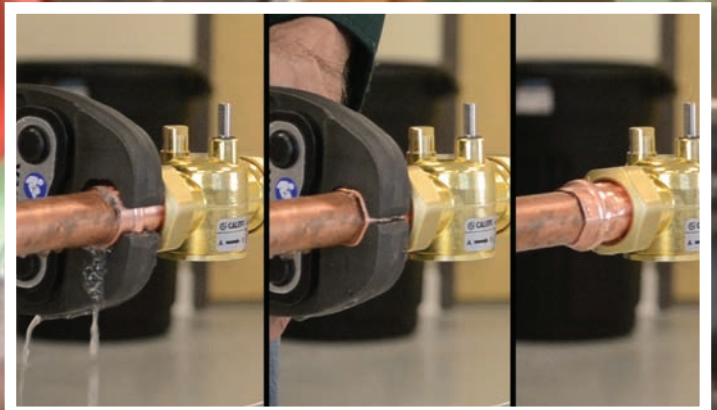



5212 Series SinkMixer™ Scald Protection Point-of-use Mixing Valve

- 4-way design simplifies piping and minimizes connection points.
- Stand-off mounting bracket for simple sturdy installation.
- Patented design, wide flow range to handle a variety of fixtures.
- Forged low lead dezincification resistant brass for durability.



Controlling and protecting your water

www.caleffi.com - Milwaukee, WI USA

CALEFFI
Hydronic Solutions

FROM THE GENERAL MANAGER & CEO

Dear Plumbing and Hydronic Professional,

It was the 1990s when I attempted my first soldering job. What a mess! Although the replacement water softener ended up working fine, my workmanship was nothing short of “bush league”. There was more solder on the basement floor



and on the outside of the pipe, than there was in the completed joint. Fortunately the softener was in my own home. I’ve long since moved on from there but would not be surprised if someday that work is posted up on one of those “hacked-up install” websites!

That experience gave me an appreciation for the skill that goes into producing a reliable pipe connection in a timely manner. Fast forwarding to today there are several new pipe joining technologies available that not only produce a reliable connection, but require significantly less time than traditional methods. As skilled labor becomes increasingly scarce, it’s likely that manufacturers will introduce even more innovate “quick-joining” technologies and methods.

This issue of idronics discusses classic and contemporary methods of joining piping in hydronic and plumbing applications. The intent is to equip designers and installers with information that helps them select pipe joining systems that are proven effective, with emphasis on modern methods that simplify and speed installation.

We hope you enjoy this issue of idronics and encourage you to send us any feedback by e-mailing us at idronics@caleffi.com.

For prior issues please visit us at www.caleffi.us, and click on the icon. There you can download the PDF files. You can also register to receive hard copies of future issues.

Mark Olson

A handwritten signature in black ink that reads "Mark Olson".

General Manager & CEO

A Technical Journal

from

CALEFFI NORTH AMERICA, INC

3883 W. Milwaukee Rd

Milwaukee, Wisconsin 53208
USA

Tel: 414-238-2360

FAX: 414-238-2366

E-mail: idronics@caleffi.com

Website: www.caleffi.us

To receive future idronics issues

FREE, register online

www.caleffi.us

© Copyright 2019

Caleffi North America, Inc.

Printed: Milwaukee, Wisconsin
USA

TABLE OF CONTENTS

5 Introduction

7 Pipe & fitting nomenclature

Pipe vs. tube
Pipe size
Pipe fitting terminology
Couplings
Elbows
Tees

Wyes
Adapters
Unions
Connection nomenclature

12 Metal pipe joining methods & materials

Steel pipe
Stainless steel pipe
Wrought iron pipe
Black iron pipe
Cast iron pipe
Copper water tube
Brass
Bronze
Metallurgical joining methods
Soft soldering
Brazing
Welding

Mechanical joining methods
Threaded joints
BSP threads
Euro-conical joints
Flanged joints
Grooved joints
Flared joints
Inverted flare joints
Push-on fitting joints
Pressed joints
Compression joints
Undersink compression joints

29 Polymer pipe joining methods & materials

Polyvinyl chloride tubing (PVC)
Chlorinated PolyVinyl Chloride
tubing (CPVC)
High-Density Polyethylene tubing
(HDPE)
Cross-linked Polyethylene tubing
(PEX)
Oxygen diffusion
Composite PEX-AL-PEX tubing
Polyethylene raised temperature
tubing (PE-RT)
PolyPropylene-random tubing
(PPR)
Fusion joining methods

Socket fusion
Butt fusion
Saddle fusion
Electrofusion
Chemical joining methods
Mechanical joining methods
Crimp ring connections
Cinched connections
Crimp sleeve connections
Cold-expansion connections
Cold-expansions/compression
ring connections
Compression fitting for polymer
pipe

41 Summary

Disclaimer: Caleffi makes no warranty that the information presented in idronics meets the mechanical, electrical or other code requirements applicable within a given jurisdiction. The diagrams presented in idronics are conceptual, and do not represent complete schematics for any specific installation. Local codes may require differences in design, or safety devices relative to those shown in idronics. It is the responsibility of those adapting any information presented in idronics to verify that such adaptations meet or exceed local code requirements.



INTRODUCTION

The use of pipe to convey water has been essential to the development of human civilization.

Historical artifacts show that Egyptians used piping made of hammered copper sheets around 3,000 BC. Piping made from hollowed bamboo or reeds was used by the Chinese as early as 2,500 BC. The Greeks used piping made of fired clay, hollowed stone and bronze around 2,000 BC. The Romans made extensive use of lead piping, and wealthy Romans enjoyed both cold and hot water delivered from that piping. The Romans also developed crude but functional valves for their piping, examples of which are shown in Figure 1-1.

Figure 1-1



During the 1600s, North American settlers used hollowed logs for piping. As people moved west during the 1800s, piping made from hollowed redwood logs was common, and in some cases preferred over early metal piping due to its resistance to decay. Figure 1-2 shows an example of wooden piping reinforced by external metal bands.

One of the first uses of cast iron pipe was to supply water to gardens at the French Palace of Versailles during the 1600s.

During the 1800s, progress in metallurgy allowed for production of seamless steel piping. Steel is now the most widely used piping material in the world, including in a wide variety of HVAC system applications.

As was true with many materials and processes, several new and specialized types of pipe were developed

Figure 1-2



Figure 1-3



Source: sewerhistory.org, United States Cast Iron Pipe & Foundry Co., 1914

during the 20th century. One of the most significant developments was polymer-based piping such as PVC, CPVC, PEX, HDPE and PP-R (Polypropylene Random). These materials are now widely used around the world for plumbing and hydronic systems. In some applications, such as hydronic radiant panel heating, hot and cold water distribution in homes, water wells, underground gas distribution, and geothermal heat pump systems, polymer piping now dominates

Figure 1-4



the market. Figure 1-4 shows two common applications: The red and blue PEX tubing is used for hot and cold water supply, while the white PVC pipe is used for drainage, waste and ventilation (DWV) systems.

Today there are hundreds of types of piping used in everything from sewer systems to the rovers exploring the surface of Mars. Pipes sizes range from those large enough for a city bus to pass through, to those so small that the cavity through which fluid passes cannot be seen by an

unaided human eye. Some pipes can handle internal pressures as high as 20,000 psi. Other specialized pipe can withstand temperatures over 2,000°F.

The usefulness of any pipe is limited by its size and length. Early pipes made of fired clay and hollowed stone were, at most, limited to a few feet in length. Thus, methods of joining multiple sections of piping together in ways that limited or eliminated leakage at the joints were fundamentally as important

as the piping itself. As coupled sections of piping were established, so too were ways to change the direction of the piping without bending it. Basic pipe fittings, such as couplings, elbows and tees, greatly expanded the usefulness of nearly all types of piping.

There are now many ways to join piping to achieve leakage-free joints able to withstand high temperatures and pressures. The “classic” methods of joining pipe, such as welding, soldering, and threading, now compete with time-saving joining systems, such as press fitting, thermal fusion, and cold expansion of shape memory piping materials.

This issue of *idronics* discusses classic and contemporary methods of joining pipe in hydronic and plumbing applications. It describes common applications, along with strengths and limitations of pipe joining systems. It provides information on the associated standards for different types of pipe and pipe joining systems. The goal is to equip designers and installers with information that helps them select pipe joining systems that are appropriate and efficient for many hydronic and plumbing applications, with emphasis on modern methods that simplify and speed installation.

PIPE & FITTING NOMENCLATURE

There are many terms used when referring to pipes and fittings. Some are precise, such as *Diameter Ratio (DR-11)*. Others are industry slang, such as “street elbow.” Those working with piping for plumbing and hydronic systems need to be familiar with these terms to enable good communication between designers, specification writers, manufacturers, supply chain staff and installers. This section covers the basic terminology and protocols used in the North American market.

PIPE vs. TUBE:

The words “pipe” and “tube” are often used loosely and interchangeably. Both refer to a closed, round conduit intended for fluid (e.g., liquid or gas) conveyance. The words *closed, round conduit* were used in the previous sentence simply to avoid a circular definition of either pipe or tube. The word conduit generally refers to pipe intended to hold electrical wiring.

The term “tube” generally refers to smooth, non-ferrous conduit intended for fluid conveyance and having approximate diameters less than or equal to 2 inches. Examples include 1/2” copper tube, 5/8” PEX tube and 1” CPVC tube. The term “pipe” is customarily used when referring to smooth, non-ferrous pipe over 2 inches in nominal diameter. Thus, one might hear reference to a 3-inch copper pipe. Strictly speaking, this is not accurate in the case of copper. Even copper “pipe” up to 12-inch pipe size is properly referred to as tube.

The term pipe is commonly used for pipes made of ferrous metals, such as steel, wrought iron or black iron.

PIPE SIZE:

The term “pipe size” also has several different and sometimes confusing meanings. In some cases, it refers to *nominal* (e.g., approximate) inside diameter. In other cases, it refers to exact outside diameter.

For tubes used in plumbing and hydronic systems in North America, pipe size refers to *nominal* inside diameter. For example, a 3/4-inch copper water tube has an exact inside diameter of 0.811 inches and outer diameter of 0.875 inches. Even though the tube is called out as a 3/4-inch copper water tube, neither its inside nor outside diameter is exactly 3/4-inch (0.750”). The outside diameter of copper water tube is, by standard, exactly 1/8-inch (0.125”) greater than the nominal tube size. This is standardized for copper water tubing ranging in sizes from 1/4-inch up to 12-inch.

Another type of copper tubing, called ACR tubing, is used in the refrigeration industry. For ACR tubing, tube

size refers to *exact outside diameter*. Thus, a 3/4-inch ACR copper tube has an exact outside diameter of 0.750 inches. ACR tubing is not used for plumbing or hydronic system applications.

The term “copper tube size,” abbreviated as CTS is sometimes used when referring to copper water tube (but not ACR tube). Some polymer tubes, such as PEX, also reference CTS. For example, the exact outside diameters of a 1/2” PEX tube and 3/4” CPVC tube are 0.625 inches and 0.875 inches, respectively. Both outside diameters are exactly 1/8-inch or 0.125 inches greater than the nominal tube size.

Another term used to describe pipe size is “Iron Pipe Size” (IPS). This designation is based on an old standard that was developed when pipe manufacturing was limited to three wall thicknesses called “standard”, “extra strong” and “double extra strong.” These designations have since been replaced by a designation for pipe wall thickness called “schedule.” What was referred to as “standard” pipe under the old IPS classification is now schedule 40 for pipes from 1/8-inch to 10 inches nominal sizes. For pipe sizes greater than 12 inches, schedule 40 refers to a wall thickness of 0.375 inches. The old IPS designation “extra strong” is now schedule 80 for pipes from 1/8-inch to 8 inches nominal size. Schedule 80 pipe larger than 8 inches nominal size has a wall thickness of 0.500 inches. The old IPS designation “double extra strong” has multiple definitions. Today this category of pipe has been consolidated to a standard wall thickness called schedule 160.

In Europe, pipe size is generally based on the DN (Diametre Nominal) standard. It refers to the *exact outside diameter in millimeters*. One example is a DN20 PEX tube, which is 20 millimeters in OD. 20 millimeters is 0.7874 inches. Although this is close to 3/4-inch, it is still different. A DN20 PEX tube will not work with the same fittings as a 3/4-inch nominal pipe size PEX tube.

PIPE FITTING TERMINOLOGY:

There are many types and sizes of piping currently used in plumbing and hydronic systems. However, that piping, by itself, is of very limited use without *fittings* that allow it to be assembled into functional systems. Common fittings allow straight segments of pipe to be joined together, or to change direction. They allow for multiple connections, or branches, to be created. Fittings also allow piping of different sizes to be connected.

It is essential for those specifying piping systems to use proper terminology when communicating the type of fittings they intend to use. This section covers the basics of common fittings used in plumbing and hydronic systems.

Common pipe fittings include the following:

- Couplings
- Elbows
- Tees
- Threaded adapters
- Unions

COUPLINGS:

Perhaps the most basic of all fittings, couplings allow two pieces of pipe to be joined together along a common centerline. The most common couplings have ports of the same size and type. Examples include a 3/4-inch coupling for joining two pieces of copper tubing, a 2-inch threaded coupling for joining two pieces of threaded steel pipe, or a 4-inch coupling for solvent welding two pieces of PVC pipe together. More recently developed couplings allow tubes made of different materials, such as copper and PEX, to be joined using a single fitting.

Standard couplings limit how far a piece of pipe can extend into the fittings. When piping with a smooth outside surface is joined using a coupling, a “stop” at the center of the fitting prevents the pipe from sliding past the mid-point of the fitting. Threaded couplings also limit pipe penetration to less than half the length of the fitting. In both cases, this allows for proper engagement between pipe segments and the coupling to ensure adequate physical strength and leak-free joints.

One variant of a standard coupling is a known as a *slip coupling*. Slip couplings do not have an internal

stop. This allows the coupling to slide (e.g., “slip”), along the smooth outer surface of some types of pipe, past the location where the two ends of the piping come together, and then slide back into a final position once the two ends of the pipes are aligned. Slip couplings are commonly used when it is necessary to align and join two pipes with a constraint that only one of those pipes can be moved to allow the slip coupling to be placed on the pipe. They are only used in piping systems where the joint can be made without moving the coupling during the joining procedure. A common example is joining two copper tubes using soldering or brazing.

Another variant of the coupling is called a *reducer coupling*. Its purpose is to allow two pipes of different sizes (e.g., diameters) to be joined. An example would be a reducing coupling that connects a 1 inch copper tube to a 3/4-inch copper tube. Reducer couplings are commonly available to transition between pipes that differ by one or two standard pipe sizes. For example, 2-inch copper reducer couplings are available to reduce to 1.5-inch or 1.25-inch tubes. In some cases, reducer couplings are available to reduce by more than two standard pipe sizes. Such fittings are generally limited to specialized applications and may require special ordering.

Reducer couplings are always specified by the larger pipe size first, followed by the smaller pipe size. For example, the proper callout for a reducer coupling that can join a 1-inch tube to a 3/4-inch tube is a 1” x 3/4” reducer coupling, not a 3/4” x 1” reducer coupling.

Figure 2-1 illustrated these types of couplings.

Figure 2-1

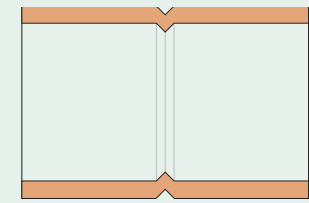

coupling w/ tube stop



slip coupling

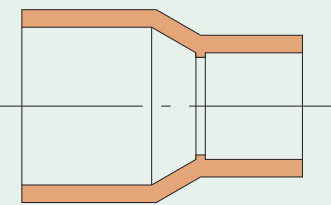

reducer coupling

ELBOWS:

Another commonly used fitting is called an elbow. These fittings allow two pieces of pipe to make a specific angular change in direction. Elbows for many types and sizes of pipe allow change in direction of 90° and 45°. Some elbows are also available for 22.5° changes in direction.

As was true for couplings, the most common elbows are for joining two pipes of the same type and size. However, elbows are now available that can join different types of pipe, such as CPVC or copper tubing to PEX tubing.

Additional variations on elbows include a *street elbow*, which has one end sized to connect over a pipe, and the other end sized to

Figure 2-2

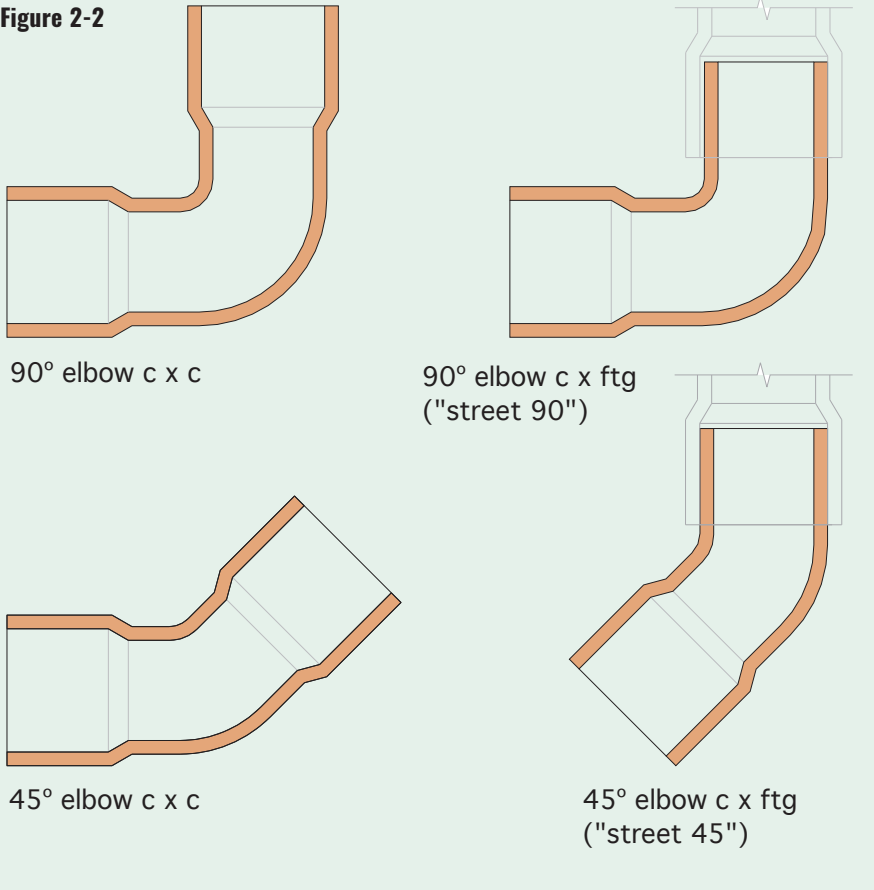

90° elbow c x c

90° elbow c x ftg
("street 90")

45° elbow c x c

45° elbow c x ftg
("street 45")

turbulence in the flow stream and thus reduce pressure drop. Long radius elbows are sometimes called "sweeps."

TEES:

Tees are used whenever a branch or "take off" is required from a pipe. Common tees have their side port configured at 90° to the main "run" of the tee between the end ports. They also have ports that connect to the same type and size piping. However, there are many variations of the basic tee.

One variation is called a reducing tee. It allows one or two of the three ports on the tee to be different pipe sizes. *When specifying a reducing tee, the larger of the two end ports of the tee should be called out first, then the size of the other end port, and finally the size of the side port.* For example, the fitting shown in Figure 2-4 would be specified as a 1" x 1/2" x 3/4" reducing tee.

Reducing tees are also available with different types of connections, such as those used for a soldered joint on the two end ports of the fitting, with the side port configured for a threaded connection.

Figure 2-3

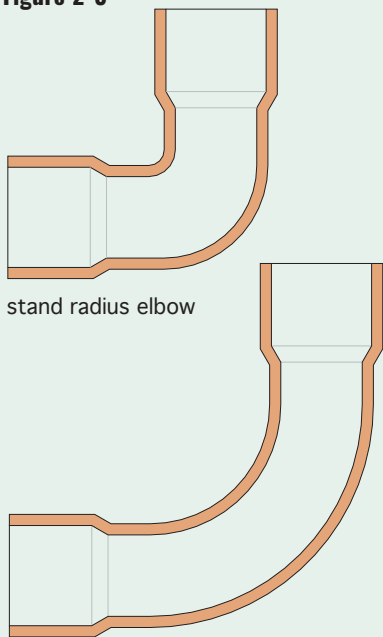

stand radius elbow

long radius elbow
("sweep")

fit inside another fitting. Figure 2-2 illustrates some of these variations.

Elbows are also available with a standard or long radius. Long radius elbows generally create less

Figure 2-4

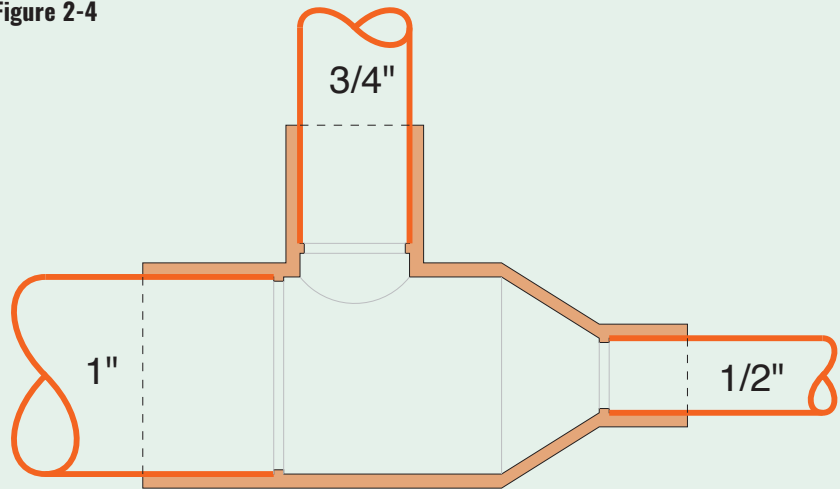

Figure 2-5

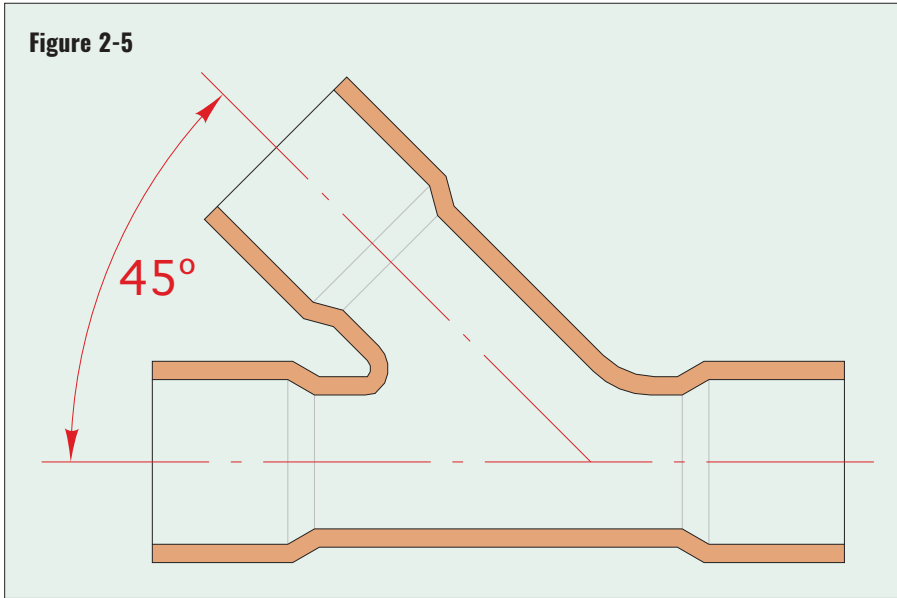
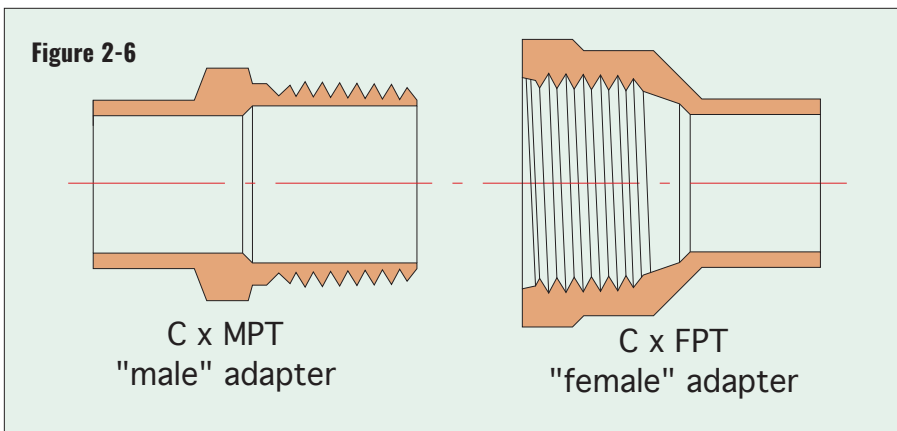

Figure 2-6



WYES:

Another variant of the basic tee fitting is called a wye. The side port of the wye is typically at a 45° angle to the centerline of the run of the tee, as shown in Figure 2-5.

Wye fittings are commonly used in drainage systems to ensure minimal resistance to flow and thus more efficient fluid conveyance when gravity is the only means of creating flow.

ADAPTERS:

In many piping systems, there is a need to connect a pipe with a smooth outer surface (such as a copper or PVC tube) to a threaded

component such as a valve. Adapter fittings are designed for this purpose.

Figure 2-7

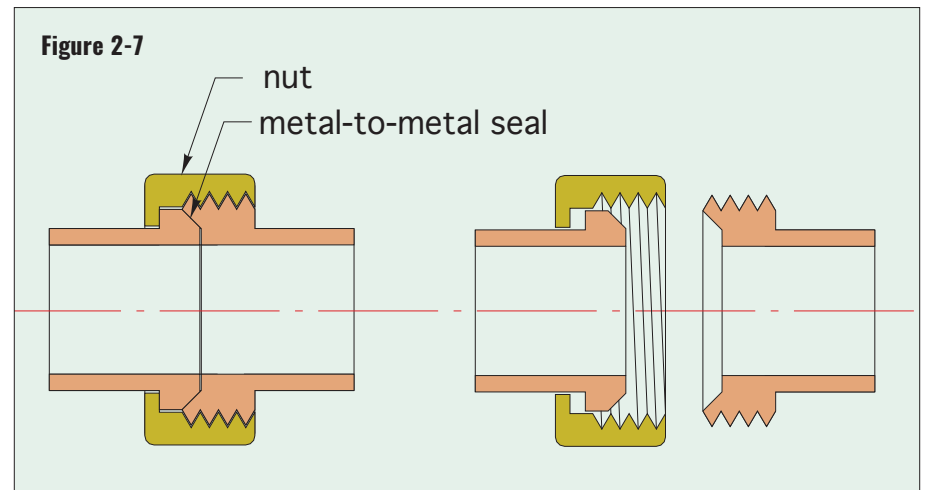

Common adapter fittings have the same size connections. They are typically specified as “male” adapters, which have external threads, or “female” adapters, which have internal threads. Both are shown in Figure 2-6.

UNIONS:

Piping systems often contain devices such as circulators, boilers, chillers, tanks and filters that may require removal for servicing. In such cases, it is desirable to have a way to separate these devices from the piping connected to them without having to cut, unsolder or otherwise damage that piping. Union fittings provide one way to do this. Unions can be opened using a pair of wrenches. One side of the union stays attached to each pipe or component. To reassemble, the two sides of the union are screwed together. Unions can be opened and closed any number of times without damaging the fitting or adjacent piping components.

Some unions use precisely machined metal-to-metal surfaces to provide a pressure-tight seal. Others rely on an O-ring or gaskets to provide the seal. Unions are available for a wide range of pipe materials, pipe sizes and connection types.

Figure 2-8



Some devices used in plumbing and hydronic systems have integrated unions at the connections, eliminating the need for a separate union fitting. Devices with integrated unions also allow each port of the device to be configured for a specific piping connection, such as threaded, soldered or press fit. Figure 2-8 shows a check valve with integrated union connections that, in this case, allow for press fitting to copper tube at each connection.

CONNECTION NOMENCLATURE:

Several abbreviations are used to describe the type of connection(s) used on pipe fittings.

The most abbreviations are as follows:

“c” implies a connection to a copper or copper alloy fitting suitable for a soldered or brazed joint

“F” or “FPT” implies female (internal) pipe threads

“M” or “MPT” implies male (external) pipe threads

“FTG” implies a connection that fits inside the socket of another non-threaded fitting

These abbreviations are often combined to describe the connection type at each port of a fitting. For example: A c x FPT adapter would have a socket for a soldered joint on one side and female pipe threads on the other side. A 1” c x 3/4” c x 1/2” FPT reducer tee would have a 1-inch soldered connection on one of the end ports, a 3/4-inch soldered connection on the other end, and a 1/2-inch female threaded side port. These basic abbreviations, used in combination with the name of the fitting, allow for hundreds of potential variations. However, not every conceivable variation is manufactured. For example, a 4” c x 1/2” M x 1” FPT reducer tee would have virtually no practical use, and thus is not commercially available.

METAL PIPE JOINING METHODS & MATERIALS

For centuries, metal has been the most commonly used material for pipe and fittings in plumbing and hydronic systems. In broad terms, metal piping systems can be divided in to two categories: ferrous and non-ferrous.

Ferrous metals contain iron, with many variations of additives and alloying elements that yield specific and desirable properties. The most common ferrous metal piping materials using in plumbing and hydronic systems are:

- Steel
- Stainless steel
- Wrought iron
- Black iron
- Cast iron

The most common non-ferrous metals used in hydronic and plumbing systems are:

- Copper
- Brass
- Bronze

This section briefly describes each of these materials and the many ways in which they can be joined together or to compatible fittings.

STEEL PIPE:

Steel pipe is extensively used in pressurized piping systems, including building heating and cooling, petroleum refinement, fuel pipelines and high-pressure steam systems. It is also used in structural applications, such as support piles under tall buildings. Figure 3-1 shows welded steel pipe and fittings in a commercial hydronic system application.

Steel pipe is manufactured as either seamless or welded. Seamless steel pipe is made by heating a cylindrically shaped “round” of solid steel until it is white hot. The round then passes through a series of rollers that exert very high pressure, causing the round to stretch in a way that forms a hole near the center. The hollowed round is placed on a “draw bench,” where a bullet-shaped piecing tool

is forced through the center of the hollowed round to help create uniformly thick walls. Additional rolling operations are used to bring the pipe to standard inside and outside diameters.

Welded steel pipe is made by passing a strip of steel through a set of rollers that form it into a cylinder of uniform wall thickness, with a single longitudinal seam. The seam edges are welded together as they pass under a welding electrode.

Seamless steel pipe is commonly used in structural applications, or other uses where the pipe will be subjected to high mechanical stress. Welded steel pipe is more commonly used in plumbing and hydronic applications.

Steel pipe is manufactured in standard sizes and wall thicknesses. In North America, steel pipe used in plumbing and hydronic applications is classified by size and schedule based on ANSI/ASME standard B36.10M. For pipes up to 12-inch, “size” refers to nominal (e.g., approximate) inside diameter. For larger steel pipes, pipe size refers to exact outside diameter.

Pipe schedule refers to wall thickness. Standardized “schedules” for steel pipe range from schedule 5 to schedule 160. The higher the schedule number, the thicker the pipe’s wall relative to the pipe’s outer diameter. A steel pipe of a given size will have the same outside diameter across the full range of pipe schedules. For example, the outside diameter of a 2-inch schedule 10 steel pipe, and a schedule 80 steel pipe are both 2.375 inches. However, the wall thickness of a 2-inch schedule 10 pipe is 0.109 inches, and that of a 2-inch schedule 80 steel pipe is 0.218 inches. Maintaining a standardized outside diameter

Figure 3-1



Celeffi Excellence
Douglas Kohiman, D.R. Kohiman, Inc. (St. Cloud, Wis.)

allows pipes of different wall thicknesses (e.g., different schedules) to be compatible with the same fittings.

The standardized outside diameter and wall thickness of steel pipe can be referenced at the following website: https://www.engineersedge.com/pipe_schedules.htm

The higher the schedule number of the pipe, the higher its pressure rating. Schedule 40 steel pipe is commonly used in hydronic applications. Schedule 80 and higher steel pipe is used in high-pressure applications.

Steel pipe is well-suited to *closed* hydronic systems (e.g., systems sealed from the atmosphere). Closed hydronic systems equipped with proper air elimination devices contain very little “free” oxygen, which, if available, will react with steel to form undesirable iron oxides. When used in open hydronic systems, steel pipe is exposed to higher levels of free oxygen. It can be partially protected against oxidation by using demineralized water, adding corrosion inhibiting chemicals or by maintaining a low level electrical current through the systems that reverses the effect of oxidation. However, most designers prefer to avoid use of steel piping in open system applications.

STAINLESS STEEL PIPE:

Stainless steel is an alloy made by adding small amounts of various elements, including chromium, nickel, molybdenum and silicon, to steel. The addition of chromium, in particular, greatly increases the corrosion resistance of stainless steel over carbon steel. Both seamless and welded stainless steel pipe is available. Figure 3-2 shows use of stainless steel piping in a hydronic system application.

Stainless steel pipe is commonly used in sanitary applications where food grade fluids or medical gases are conveyed. The premium cost of stainless steel pipe over that of standard steel pipe limits its extensive use in hydronic systems. However, short, pre-threaded lengths of stainless steel pipe, known as “nipples,” are occasionally used in hydronic systems. Figure 3-3 shows and example of a threaded pipe nipple.

In North America, stainless steel pipe sizes and schedules are based on ANSI/ASME 36.19M. Sizes range from 1/8” to 12” nominal inside diameter. Schedules range from 5S through 80S. The exact dimensions associated with these sizes and schedules can be found at: https://www.engineeringtoolbox.com/ansi-stainless-steel-pipes-d_247.html

Figure 3-2



Caleffi Excellence
Dave Kaibel, Comfort Sales Agency, Inc. (Blue Springs, Mo.)

Figure 3-3



WROUGHT IRON PIPE:

Wrought iron is iron with a carbon content of less than 0.08 percent. Reducing the carbon content of the iron creates a material with high malleability that can be shaped and stretched when heated without

creating high residual stresses. Similar to steel piping, wrought iron piping is manufactured by subjecting a heated “round” of low carbon iron to a series of rolling and piercing operations. The primary use for wrought iron is ornamental landscaping features such as fences and gates. It is also used in blacksmithing. Although older buildings may contain lots of wrought iron piping, very little wrought iron piping is currently commercially available, being largely displaced by steel piping.

BLACK IRON PIPE:

Black iron pipe is steel pipe with a black coating that limits surface oxidation. It is highly malleable and thus relatively easy to thread. Its primary use, at present, is for gas and fuel supply piping, although some installers use it for near boiler piping assemblies such as headers. Because of the labor required to join all piping and fittings using threaded connections in comparison to more contemporary piping systems, black iron pipe is seldom used to build an entire hydronic system.

CAST IRON PIPE:

Cast iron pipe has been extensively used in the plumbing industry for centuries. Today, cast iron pipe is primarily used for DWV (drainage, waste and ventilation) piping systems in buildings. It is not used for in-building water supply or in hydronic heating/cooling systems.

Cast iron pipe can withstand many decades of service in such applications and has relatively high strength when used in underground piping. The mass associated with cast iron piping also gives it desirable sound-suppressing characteristics that minimize the sound of wastewater streams within buildings.

Unlike wrought iron and steel pipe, which is largely shaped by mechanical means (e.g., rolling, stretching and piercing), cast iron pipe is made by pouring molten iron into molds. One of the earliest molding processes that is still used today forms a larger diameter “bell” at one end of the cast pipe. The inside diameter of this end of the pipe is large enough to allow the end of another pipe to slide several inches into the bell. The space between the inside diameter of the bell and the outside diameter of the inserted pipe is filled with a sealing material such as molten lead. This method of joining is called a *bell and spigot* joint.

Today, what is commonly referred to as *no-hub* cast iron pipe is made with a constant outside diameter. It is joined using flexible elastomeric sleeves surrounded by metal compressing rings, an example of which is shown in Figure 3-4.

Figure 3-4



These couplings reduce stress in the pipe and accommodate slight misalignment of piping while also providing a tight seal.

COPPER WATER TUBE:

Developed during the 1920s, copper water tube is now the most common non-ferrous metal piping used in plumbing and hydronic systems. The popularity of copper tubing as an alternative to steel and iron piping greatly increased during the 20th century. It was much lighter than steel or iron piping, had relatively good corrosion resistance in both plumbing and hydronic system applications, and could be joined using soft soldering, which is generally considered easier and faster than threading or welding. The smooth inside surface of copper tubing also creates less resistance to flow compared to the inner surfaces of steel or iron pipe. Copper also has very high thermal conductivity, which enhances the performance of devices such as air handler coils or finned-tube elements that are intended to absorb heat from fluid passing through tubing.

Copper tubing is available in a wide range of sizes and wall thicknesses. The type of tubing used in plumbing and hydronic systems is called *copper water tube*. In the United States, copper water tube is manufactured according to the ASTM B88 standard. In this category, pipe size refers to the nominal (e.g., approximate) inside diameter of the tube. The outside diameter of copper water tubes is always 1/8-inch larger than the nominal inside diameter.

Another category of copper tubing, designated as ACR tubing, is used in refrigeration and air conditioning systems. In this category, pipe size refers to the outside diameter of the tubing. ACR tubing is not used in hydronic heating or water distribution systems.

Copper water tube is available in three wall thicknesses designated as types K, L and M, in order of decreasing wall thickness. The outside diameters of K, L and M tubing are identical. This makes all three types compatible with the same fittings and valves.

Figure 3-5

Nominal tube size (type M copper)	Inside diameter (inches)	Outside diameter (inches)	Rated working pressure (psi) @200 °F service temp.
3/8"	0.45	0.5	855
1/2"	0.569	0.625	741
3/4"	0.811	0.875	611
1"	1.055	1.125	506
1.25"	1.291	1.375	507
1.5"	1.527	1.625	497
2"	2.009	2.125	448
2.5"	2.495	2.625	411
3"	2.981	3.125	380

Because the operating pressures of residential and light commercial hydronic systems are relatively low, the thinnest-wall copper tubing (type M) is most often used. This wall thickness provides several times the pressure rating of other common hydronic system components. In the absence of building or mechanical codes that require otherwise, type M is the standard for copper tubing used in hydronic systems. Some plumbing codes also allow type M copper tubing to be used for residential domestic water supply piping.

Figure 3-5 gives the dimensions and pressure ratings for type M copper tubing.

Type L copper tubing is commonly used in domestic water supply piping. Its slightly thicker wall provides a high degree of long-term corrosion resistance.

Type K copper tubing was, at one time, commonly used for underground water supply piping,

such as between a water main and a building. However, modern polymer materials such as polyethylene have largely displaced the use of copper tubing for such applications.

Two common hardness grades of copper water tube are available. Hard-drawn tubing is supplied in straight lengths of 10 and 20 feet. Because of its straightness and strength, hard-drawn copper tubing is the most commonly used type in hydronic and plumbing systems.

“Soft-temper” copper tubing is annealed during manufacturing to allow it to be formed with simple bending tools. It is useful in situations where awkward angles do not allow proper tubing alignment with standard fittings and straight lengths of hard-drawn copper tubing. Soft-temper tubing comes in flat coils having standard lengths of 60 feet. The minimum wall thickness available in soft-temper copper tubing is type L.

BRASS:

Brass is a copper alloy, a mixture of copper with zinc, and in some cases, with small amounts of lead. Although brass has been used for tubing that conveyed water, it is not currently used as the primary *tubing* material in modern plumbing or hydronic systems. It is extensively used for pipe fittings and components such as valves, air separators, strainers, and other specialty devices in both hydronic and plumbing systems. Brass is highly malleable, and as such, is well-suited to forging, threading and machining processes. It also has good resistance to corrosion in open hydronic systems and plumbing systems.

The primary use for brass tubing is in ornamental applications and specialty markets, such as brass musical instruments.

Modern plumbing codes now require that brass piping components that come in contact with potable water must be fabricated from “low lead” brass to minimize exposure to lead. Based on NSF/ANSI Standard 372, low lead brass can contain no more than 0.25% lead when used on surfaces that contact potable water within valves, fittings or fixtures. Low lead brass is not required for components used in hydronic systems that do not contact potable water.

BRONZE:

When copper is alloyed with tin, the resulting material is bronze, a highly malleable material that is easily machined. During the 20th century, bronze was used for some DWV piping within buildings. It was joined using soft soldering. Today, bronze is not commonly used as a tubing material in plumbing or hydronic systems, but it is used for fittings and valves installed.

Figure 3-6

Solder type	Service temperature	Maximum allowed pressure (psi) (1/4" to 1" tube)	Maximum allowed pressure (psi) (1.25" to 2" tube)	Maximum allowed pressure (psi) (2.5" to 4" tube)
50/50 tin/lead	100	200	175	150
	150	150	125	100
	200	100	90	75
	250	85	75	50
95/5 tin/antimony	100	500	400	300
	150	400	350	275
	200	300	250	200
	250	200	175	150

METALLURGICAL JOINING METHODS:

Steel, wrought iron and black iron piping, as well as copper tubing, can be joined using materials and methods that create a true metallurgical joint. In some cases, the butt ends of adjacent and aligned steel pipe can be directly joined by welding. In other cases, a fitting is required.

SOFT SOLDERING:

One method that’s commonly used to metallurgically join copper tubing in hydronic and plumbing systems is soft soldering. This is a process in which a molten filler metal with a low melting point, called the *solder*, is drawn by capillary action between the heated outer surface of a copper tube and the heated inner surface of the copper or copper alloy fitting, valve or other component. When it cools, the solder forms a rigid and leak-free molecular level bond with the copper or copper alloy surfaces.

Several types of solder are available. One traditional solder used for joining copper tubing in non-potable applications is a mixture of 50% tin and 50% lead. However, code changes over the last two decades do not allow lead-based solders to be used in any piping system that

conveys potable water. Alternatives include a 95% tin/5% antimony solder, and several other “no-lead” solder formulations. 50/50 solder has a lower melting temperature range of 361 to 421°F, compared to the melting temperature range of 95/5 solder, which is 452 to 464°F. Lower melting temperature is helpful when making the joint but limits the pressure and temperature to which the joint can be exposed.

The working pressure rating of soldered joints depends on operating

temperature and tube size. Figure 3-6 lists working pressure ratings for two types of solder over a range of working temperatures and pipe sizes. These pressure ratings are well above the relief valve settings of most residential and light commercial hydronic systems. They are also above the temperature/pressure conditions found in most building water supply systems.

Proper soldering requires that the surfaces being joined are mechanically and chemically clean. The outer surface of a copper tube is mechanically cleaned using abrasive fabric or a specially shaped wire brush. The inside surface of the fitting or component to which the tube will be soldered is similarly cleaned. A solder flux is then brushed onto the outside surface of the tube and inside surface of the fitting where these surfaces will overlap. Solder fluxes typically contain an acid that, when heated, rapidly scours the surfaces to be joined of fingerprints or other films that could interfere with proper metallurgical bonding. After the flux is applied, the tube is pushed into the socket of the fitting or component until it bottoms out on the internal stop. The clearance

Figure 3-7



Figure 3-8



Figure 3-9



Caleffi Excellence
Alexandru Dobos, American Plumbing Heating and Solar (Vail, Colo.)

between the outside of the tube and the inside of the fitting is limited to a few thousandths of an inch. Heat from a torch operating on map gas or acetylene is then applied evenly around the outside of the joint. The goal is to evenly heat the joint, but in the process, avoid burning the flux. Once the joint reaches the melting point of the solder, the solder, which is in the form of a 1/8-inch diameter wire, is placed at the outer surface of the joint, as seen in Figure 3-7.

The solder quickly melts and is subsequently drawn deeper into the joint by capillary action. When good technique is used, the solder is evenly spread across the entire contact area between the tube and fitting. Any molten solder dripping from the joint implies that the joint is filled. Good soldering technique concludes with a “wiped” joint. A cloth is quickly wrapped and rotated around the still-hot joint to remove any excess solder. Several examples of neatly wiped soft solder joints are shown in Figure 3-8.

BRAZING:

Another metallurgical joining method for copper and copper alloys is called brazing. The process is similar to soft soldering but takes place at significantly higher temperatures (above 840°F). Various filler metals are used, including alloys made from copper, tin and zinc. Silver alloys are also used for “silver soldering,” which is a type of brazing. The temperatures required from brazing are achieved using an oxyacetylene torch. The fluxing material is generally contained in the brazing rod along with the filler metal. Brazed joints are mechanically stronger than soft soldered joints and have higher temperature and pressure ratings. They are commonly used for joints in refrigeration piping, solar collector absorber plates, or other devices which will operate at temperatures and pressures above those suitable for soft soldering. Brazing is also used in fabricating components such as copper headers that can be part of plumbing or hydronic systems. Figure 3-9 shows an example of brazed joints used to form branch connections on a prefabricated copper header. Brazing is not

commonly used for the majority of joints in standard plumbing and hydronic systems.

WELDING:

Metallurgical joints in steel and iron pipe are created by welding. Two pieces of straight pipe of suitable size and schedule can be joined by groove welding. Figure 3-10 shows two completed groove weld joints on a steel reducer coupling.

Figure 3-10



Groove welding requires the ends of the pipes being joined to be chamfered to a specific angle and depth. Steel pipe can be ordered with specified chamfer depths and angles to speed onsite work. The welding process begins with proper alignment of the pipes. Several “tack” welds are made at the base of the groove and around the perimeter of the joint to hold the pipes in alignment. The process continues as the welder burns the welding rod alloy into both sides of the groove, and continuously around the circumference of the joint. Depending on the size and thickness of the pipe, and the desired pressure rating of the joint, several passes around the joint may be required. The slag formed with each pass must be removed with a chipping hammer. In critical applications, the joint may be X-rayed at several stages to verify proper joining. Welded joints are not typically used for small diameter steel pipe (2-inch size and smaller) in standard hydronic systems that operate at relatively low pressures and temperatures. Welded joints are commonly used for larger sizes of steel pipe in commercial or industrial hydronic systems.

Welding is also used to attach certain types of flanges to piping. The welded-on flange is then bolted to an adjacent flange. Flange joints are discussed later in this issue.

MECHANICAL JOINING METHODS:

Mechanical pipe joining methods do not require heating. Some mechanical joints, such as those using threaded pipe and fittings, have been used for many decades. Other methods, such as press fitting, are relatively new. They were developed to reduce the time, complexity and skill required for installing piping systems compared to more traditional joining methods.

THREADED JOINTS:

One of the oldest methods for mechanically joining pipe to fittings and other components is by threading. Standardized *tapered* threads are cut into the outer surface of the pipe. These threads mate to equally tapered threads machined on the inside of a fitting, valve or other piping component. The taper of the threads is what allows the joint to tighten and seal as the two components are twisted together. The straight or “parallel” threads used on bolts, nuts and parts of other pipe joining systems do not provide this effect. Figure 3-11 shows an example of internal (e.g., “female”) threads machined into the body of a valve, and matching external (e.g., “male”) threads machined onto another component.

Before joining threaded components, a thread sealant is applied to the male (e.g., external) pipe threads. Commonly used sealants include a variety of brushed-on pastes called pipe “dope,” and thin, non-adhesive

Figure 3-11



tape made of polytetrafluoroethylene (PTFE), commonly known by the trade name Teflon®. The primary function of the thread sealant is to fill tiny crevices between the interlocking threads. It also lubricates the joint as it is assembled and reduces the potential for corrosion within the joint. Sealants also make it easier to disassemble the joint, if necessary, especially after many years of service. Although there are some tapered pipe threads that are designed to seal without the use of thread sealants, they are seldom used in the plumbing or hydronic industry. Figure 3-12 shows an example of a threaded brass fitting being coated with pipe dope prior to being joined to a matching threaded component.

Figure 3-12

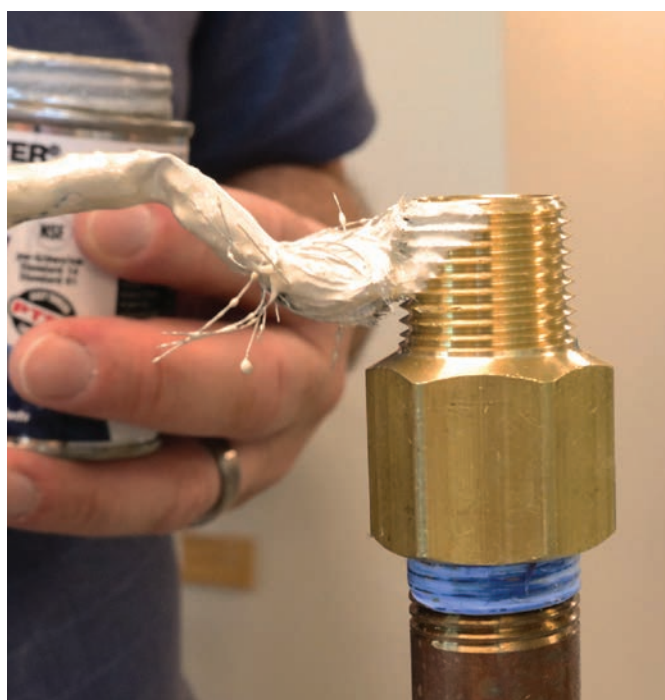

After a thread sealant is applied, the threads are initially engaged by hand turning the two objects being joined. The objects must be maintained in alignment during this step to ensure proper thread engagement. Poor initial alignment can result in “cross threading” which can irreparably damage the threads as they are tightened.

As the threads draw together, the taper in their design creates progressively more interference between the surfaces of the threads. This interference increases the torque needed for further tightening. Eventually, a wrench is required *on both sides of the joint* for further tightening. As the joint tightens, the thread sealant undergoes very high mechanical stress, which causes it to fill tiny crevices or other very small imperfections between the mated threads. This is crucial in obtaining a joint capable of withstanding significant internal pressure.

The quality of the tapered threads will, in part, determine the number of turns necessary to complete the joint. Precisely machined threads tend to allow more turns, and thus better engagement of the two components. Experienced pipefitters develop a feel for how much torque is needed to complete the joint without over stressing it. A typical tapered thread joint requires 3.5 to 4.5 turns between the two components to complete the joint.

Figure 3-13



Caleffi Experience
Darryl Saunders, The Hydronics Team (Toronto, Ont.)

In North America, the standard for threaded pipe joints in most hydronic and plumbing applications is called *national pipe thread*, abbreviated as NPT. The exact thread pitch and taper of NPT threads is stated in ANSI/ASME standard B1.20.1 as one inch of radial distance change over 16 inches of longitudinal length. This corresponds to a taper angle of 1.7899°. Maintaining consistency when machining NPT threads is critical. It allows many different types and sizes of pipe and piping components to be joined to form pressure-tight joints.

NPT threads on the *external* surface of a pipe or other components are more specifically referred to as *male* pipe threads, and often abbreviated as “MPT”. NPT threads on the *interior* surface of a fitting, valve or other component are referred to as *female* pipe threads, abbreviated as FPT.

Tapered pipe threads are used on many different piping materials including iron, steel, brass, stainless steel, copper, PVC and CPVC. Figure 3-13 shows several threaded pipe joints.

BSP THREADS:

BSP stands for *British Standard Pipe*, which is an ISO 228 thread standard used throughout the world.

There are two types of BSP threads: BSPP, a parallel “straight” thread, and BSPT, a tapered thread. External BSPP threads, which are also called “G” threads, are often machined onto the ports of components such as valves. They work in combination with a nut, piping tailpiece and a washer. Figure 3-14 shows an example of these components that combine to allow a copper tube to be joined to the stainless steel body of a check valve.

As the nut is tightened onto the valve body, the fiber washer is mechanically compressed between two flat

Figure 3-14



metal surfaces, one on the component and the other on the tailpiece. The compressed washer seals the joint. The BSPP threads do not provide any seal, only mechanical force to compress the washer.

BSPT is a tapered thread similar to, but not identical to NPT. It is also sometimes called an R-thread. It has rounded surfaces at the root and peak of the thread, compared to flat surfaces at these locations on NPT threads. The angle of BSPT threads is 55°, compared to a 60° thread angle on NPT threads. Although these differences in thread design are slight, BSPT and NPT threads should not be combined on the same joint.

EURO-CONICAL JOINTS:

Euro-conical joints are often used to connect PEX or PEX-AL-PEX tubing to manifolds, panel radiators or adapters to other types of pipe.

A Euro-conical joint consists of several components: A brass nut with internal straight threads, a compression ring, an insert fitting with O-rings, and a receiving component (such as a manifold body or adapter to another type of pipe) with matching external straight threads.

Figure 3-15 shows a 1/2" PEX-AL-PEX tube, over which is a brass nut and a (blue) compression ring. The insert portion of the fitting is seen on the far right.

Figure 3-15

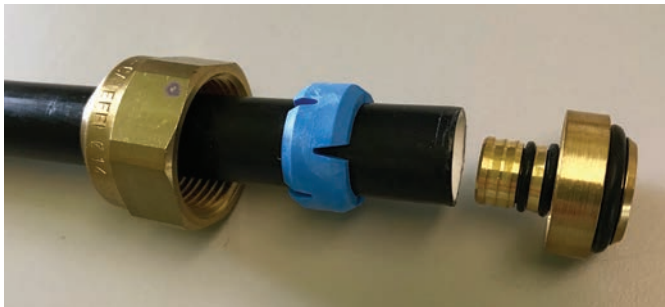

The neck of the insert is fitted with two O-rings and slides into the end of the PEX-AL-PEX tube. The other end of the insert fitting has been machined to a standardized conical shape. This conical surface mates with a matching surface on the receiving component, in this case a manifold body. These surfaces are self-aligning as the joint is assembled, as can be seen in Figure 3-16.

As the nut is screwed onto the joint, the compression ring creates pressure between the small O-rings on the neck of the insert fitting and the inside surface of the tube. This creates a seal between the insert fitting and the tube. The large O-ring on the other end of the insert

Figure 3-16



fitting is also compressed to form a seal between the insert fitting and receiving component. These two seals combine to provide a pressure-tight joint between the tube and the receiving component. As is true with BSPP threads, the straight threads used in a Euro-conical joint only provide the mechanical force necessary to compress a sealing device, such as a gasket or O-ring. The threads themselves do not create the seal. Euro-conical joints can be reopened with a wrench if necessary without damaging any portion of the associated hardware.

FLANGED JOINTS:

Another long-established method of mechanically joining pipe and piping components uses standardized sizes of bolt-together discs, which are called flanges. Figure 3-17 shows an example of a flange connection on a large air separator.

Figure 3-17

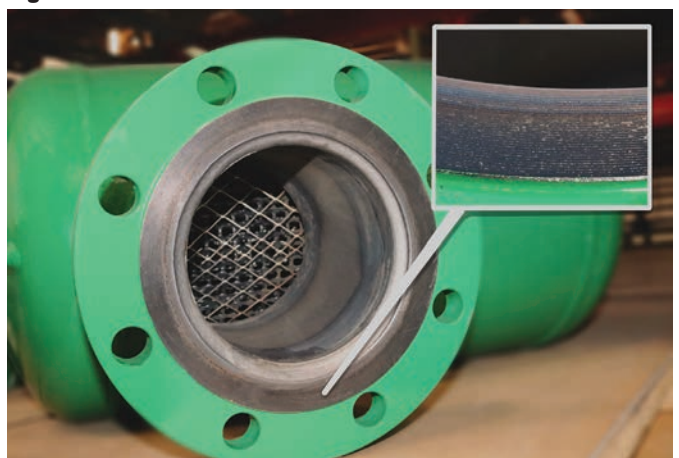
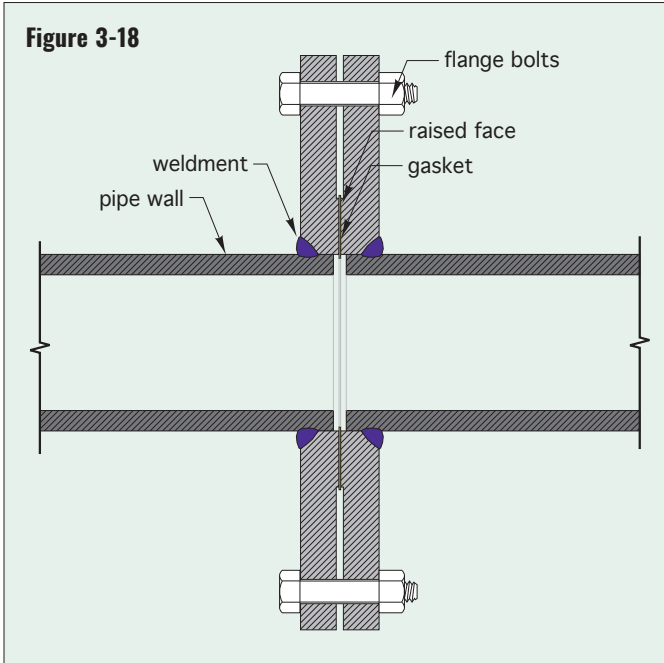

Figure 3-18



the fine grooves present on the inner portion of the flange. This portion of the flange is called a “raised face.” It projects 1/16-inch outward from the green painted portion of the flange. When two flanges are aligned, and the bolts are tightened, the concentric grooves on the raised face penetrate into a gasket placed between the two mating flanges. This is where the seal is created. The bolts hold the two flanges together with sufficient force to accommodate the pressure within the system and maintain the seal at the gasket.

Flanged joints can be used with a wide range of pipe types and materials. They are commonly used with steel piping in sizes greater than 2 inches. A flange disc having a specific diameter and one of several standardized bolt patterns is welded to the outside surface of the steel pipe, as illustrated in Figure 3-18. That flange can then be connected to another identical flange on another pipe, or to a component such as the valve shown in Figure 3-19.

Flanges are also available with FPT tapered threads that screw onto the MPT threads of a pipe. An example of such a flange, along with the sealing gasket and bolts, is shown in Figure 3-20.

Figure 3-19



Figure 3-20



Some flanges have a “raised” face which concentrates the compression force developed between the flanges on a gasket. Other flanges have precisely machined grooves that hold an O-ring in a concentric position between two mating flanges. The seal occurs at the compressed O-ring.

Flanges are categorized into “classes” that range from “150#” to “2500#.” The # symbol stands for pound, but this designation is often misinterpreted as the pressure rating of the flanged joint in pounds per square inch (PSI). This is not the case. The pressure rating of a specific class of flange joint depends on the operating

This particular flange requires 8 bolts, which pass through equally spaced holes to connect to an identical flange on another component or length of pipe. Some flanges use 4 and 6 equally spaced bolts. The inset photo shows

Figure 3-21

maximum (non-shock) pressure for ASTM 105 carbon steel flanges				
	class 150	class 300	class 400	class 600
service temperature (100 °F)	285 PSI	740 PSI	990 PSI	1480 PSI
service temperature (200 °F)	260 PSI	675 PSI	900 PSI	1350 PSI
service temperature (300 °F)	230 PSI	655 PSI	875 PSI	1315 PSI
service temperature (400 °F)	200 PSI	635 PSI	845 PSI	1270 PSI
service temperature (500 °F)	170 PSI	600 PSI	800 PSI	1200 PSI

temperature of the system and the material the flange is made of. Figure 3-21 gives pressure ratings for a selection of ASTM 105 carbon steel flanges.

The maximum operating pressure of the flanged joint decreases with increasing system temperature. 300# class flanges have significantly higher pressure ratings compared to 150# class flanges. However, even 150#

flanges have pressure ratings well above the relief valve settings used in most hydronic heating and cooling systems.

Figure 3-22 gives dimensional data for both 150# and 300# flanges.

300# flanges are thicker than 150# classes. The outside diameter of 300# flanges is also larger than that of 150# flanges. The number of bolt

holes and the size of the required bolts are also larger on some 300# flanges compared to a 150# flange of the same pipe size.

One benefit of flanged joints is the ability to disassemble the joint if required. When this is done the gasket between the flange surfaces is usually replaced. The bolts, nuts and washers are typically reused.

Figure 3-22

150 lb. Standard flanges						300 lb. Standard flanges					
nominal pipe size (inch)	outside diameter of flange (inch)	flange thickness (inch)	# holes	diameter of bolts (inch)	diameter of bolt circle (inch)	nominal pipe size (inch)	outside diameter of flange (inch)	flange thickness (inch)	# holes	diameter of bolts (inch)	diameter of bolt circle (inch)
1/2	3-1/2	7/16	4	1/2	2-3/8	1/2	3-3/4	9/16	4	1/2	2-5/8
3/4	3-7/8	1/2	4	1/2	2-3/4	3/4	4-7/8	5/8	4	5/8	3-1/4
1	4-1/4	9/16	4	1/2	3-1/8	1	4-7/8	11/16	4	5/8	3-1/2
1-1/4	4-5/8	5/8	4	1/2	3-1/2	1-1/4	5-1/4	3/4	4	5/8	3-7/8
1-1/2	5	11/16	4	1/2	3-7/8	1-1/2	6-1/8	13/16	4	3/4	4-1/2
2	6	3/4	4	5/8	4-3/4	2	6-1/2	7/8	8	5/8	5
2-1/2	7	7/8	4	5/8	5-1/2	2-1/2	7-1/2	1	8	3/4	5-7/8
3	7-1/2	15/16	4	5/8	6	3	8-1/4	1-1/8	8	3/4	6-5/8
3-1/2	8-1/2	15/16	8	5/8	7	3-1/2	9	1-3/16	8	3/4	7-1/4
4	9	15/16	8	5/8	7-1/2	4	10	1-1/4	8	3/4	7-7/8
5	10	15/16	8	3/4	8-1/2	5	11	1-3/8	8	3/4	9-1/4
6	11	1	8	3/4	9-1/2	6	12-1/2	1-7/16	12	3/4	10-5/8
8	13-1/2	1-1/8	8	3/4	11-3/4	8	15	1-5/8	12	7/8	13
10	16	1-3/16	12	7/8	14-1/4	10	17-1/2	1-7/8	16	1	15-1/4
12	19	1-1/4	12	7/8	17	12	20-1/2	2	16	1-1/8	17-3/4

GROOVED JOINTS:

Another way to join steel piping to itself or fittings is by grooved joints. A cutaway of a grooved joint between two steel pipes is shown in Figure 3-23. Figure 3-24 shows a cross sectional view of a grooved joint. Figure 3-25 shows a tee connecting steel pipe using grooved joints.

Figure 3-23

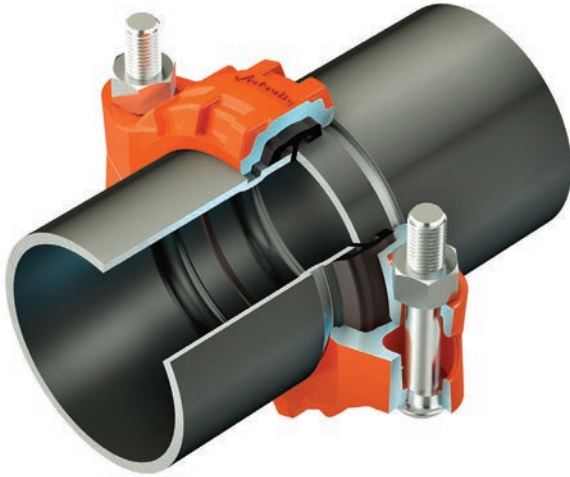

Courtesy of Victaulic

As the name suggests, grooved pipe joints require specifically placed and shaped grooves around the circumference and a short distance in from the end of the pipe. Specialized tools are required to cut these grooves.

After grooving, a cast iron clamp fitting with an internal elastomeric gasket is slipped over one of the pipes. The end of the other pipe is slipped into this fitting, but a small gap remains between the two pipe ends. The bolts on the clamp ring are tightened to a specified

Figure 3-24

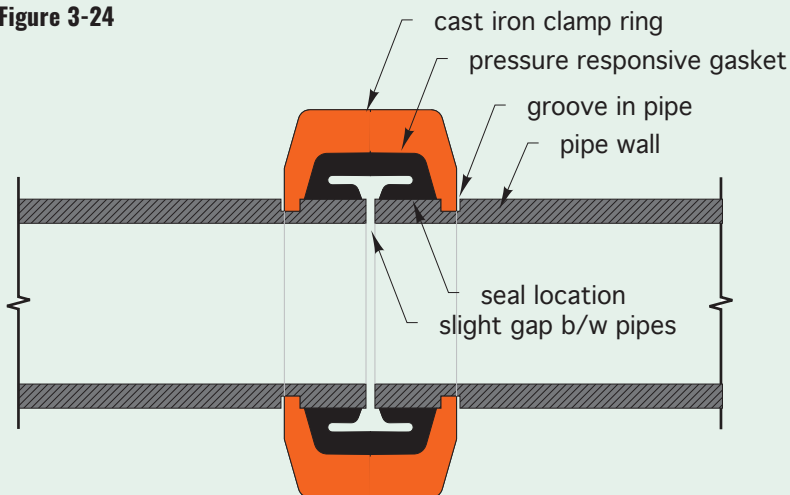

Figure 3-25



torque compressing the elastomeric gasket against the outer surface of each pipe and the inner surface of the clamp fitting. The seal is created where the gasket contacts the outer surface of each pipe. The clamp ring is designed to hold the gasket in place over a wide range of temperatures and pressures. It also allows some expansion and contraction movement of the pipe without failure of the seal.

The seal created by the shaped gasket within the clamp fitting is “pressure responsive.” As pressure increases within the pipe, so does the force pressing the gasket against the outer surface of the pipe and inner surface of the clamp fitting. The greater the pressure in the pipe, the stronger the seal.

One benefit of grooved piping joints is the ability to absorb minor angular movement of the pipes without seal failure. This reduces stress on the pipe and allows it to withstand a certain degree of flexing, such as during a limited seismic event. Grooved piping joints also help attenuate vibration along the piping path.

Grooved joint fittings and associated tools are also available for certain sizes and schedules of copper tubing and PVC pipe.

FLARED JOINTS:

Flared joints have been in service for decades. They are typically used with small diameter soft-temper copper tubing in applications such as gas and oil supply, and for refrigeration piping.

A flared joint creates a metal-to-metal seal between a soft-temper copper tube with an end that has been shaped into a flared-out cone, and a matching cone-shaped metal surface on a receiving object, such as the port of a valve or a filter/drier in a refrigeration system. The mating metal surfaces are held together by straight internal threads on a brass flare nut and matching external threads on the receiving object. These details are shown in Figure 3-26.

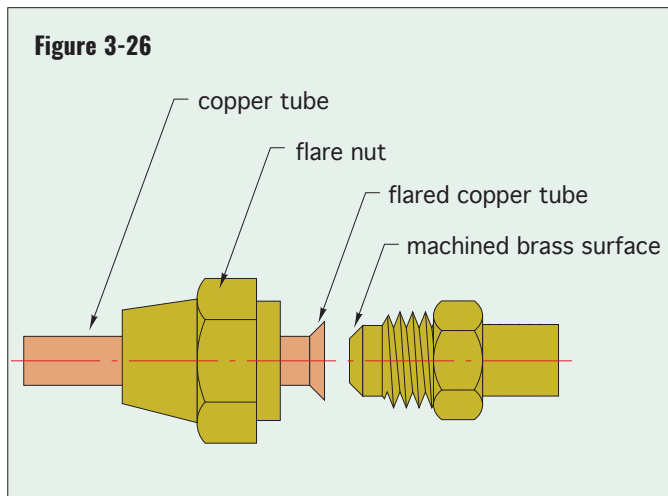

Figure 3-27



Figure 3-28



The joint fabrication begins by sliding the flare nut over the tube and moving it back a few inches from the end. The tube is then clamped into a hardened steel jig called a flaring bar. The flaring bar has holes calibrated for several different tube sizes. When clamped into the flaring bar, the end of the tube is surrounded by a cone-shaped, hardened steel cavity. Another tool, called a flaring yoke, is then slipped over the flaring bar. The flaring yoke, seen in Figure 3-27, contains a nose cone-shaped mandrel mounted on a threaded shaft. The person making the joint turns the screw handle on the flaring yoke.

The mandrel within the flaring yoke is forced into the end of the tube, reshaping it into a cone that resembles the bell of a trumpet. The tube is then removed from the flaring bar. The flared end of the tube is aligned with the cone-shaped end of the receiving object, and the flaring nut is tightened to force the two cone-shaped metal surfaces together. See Figure 3-28.

Care must be taken not to over-tighten the flaring nut. Doing so can over stress the flared end of the copper tube causing it to crack or shear off. Excessive tightening also causes high radial stress on the flaring nut, which can cause it to crack.

INVERTED FLARE JOINTS:

A standard flare nut has internal threads that mate with external threads on the object the tube connects to. Inverted flare joints use the opposite thread design — an external thread on the flare nut mates to an internal thread on the object the tube connects to, as seen in cross section in Figure 3-29.

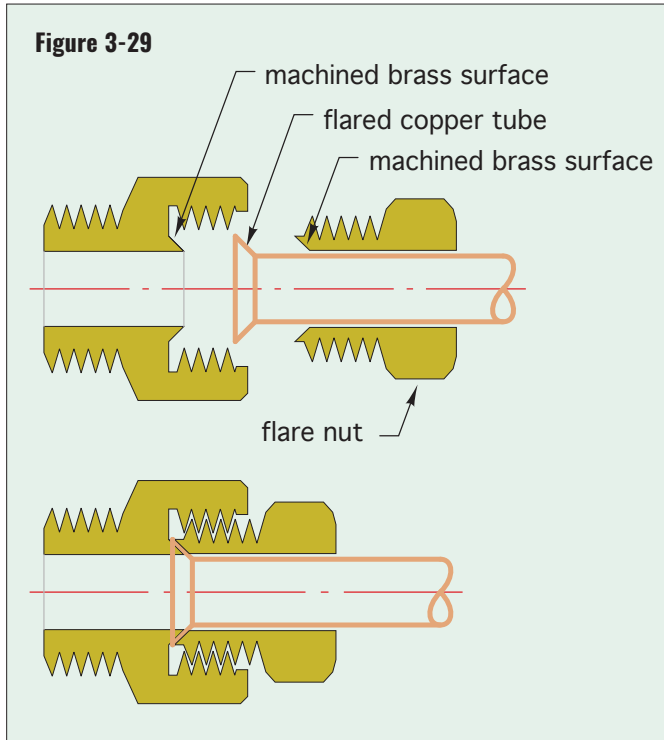

Inverted flare joints create less stress on the flaring nut and are less prone to failure due to overtightening. Inverted flare joints also offer excellent resistance to vibration. They are often used in brake lines in vehicles.

As with standard flare joints, the seal of an inverted flare joint is metal-to-metal where the flared end of the tube meets an equally angled surface on the component the tube attaches to.

Figure 3-30



Inverted flare joints can be opened with a wrench, allowing the component they attach to be removed without cutting the connecting tube.

Figure 3-30 shows an example of a tailpiece for a zone valve where an inverted flare joint is used at the valve body, transitioning to a copper sweat adapter.

PUSH-ON FITTING JOINTS:

One of the newest technologies for connecting pipe to other pipes and fittings is called a “push-on” or “push-to-fit” fitting. It can be used on a variety of smooth surface pipes, including copper, PEX, PVC and CPVC. It is one of very few fittings that can be installed without tools, making it a popular choice for do-it-yourselfers who need to make minor repairs or modifications to existing plumbing systems. It is especially helpful in situations where water is trickling from a pipe at the location where a joint is needed. That situation precludes soldering, brazing, or solvent welding. The ability of push-on fittings to accept different types of tubing at each end of the fitting also makes it possible to repair or modify an existing copper plumbing system using PEX, PVC or CPVC tubing without need of specialized tools or bonding materials.

Figure 3-31 shows the internal detail of a push-on fitting, and how it can be used to join a PEX tube to a copper tube.

Figure 3-31

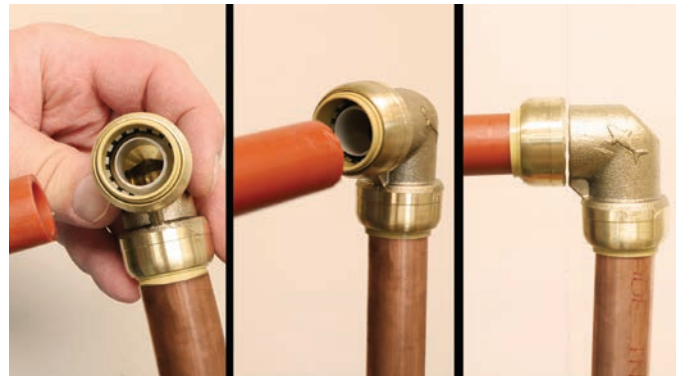

To make a connection, the end of a tube is cut square and deburred. It is then simply pushed into the fitting until the end of the tube contacts the tube stop. As the tube passes into the fitting, it slides past a seated stainless steel ring that has several sharp teeth angled toward the center of the fitting. The tube also passes through an O-ring. Because of their angle, sharpness and spring temper, the stainless steel teeth press against and slightly penetrate the outer surface of the tube. This action prevents the tube from being pulled backward out

of the fitting. When the joint is put under pressure, the “holding power” of these teeth increases as the pressure increases. With the tube restrained within the fitting, the seal is made at the O-ring.

If necessary, the tube can be removed from the fitting using a simple plastic “release tool” that snaps over the tube. The release tool is pushed against the neck of the push-on fitting. The neck moves slightly into the fitting and temporarily lifts the gripping teeth above the outer surface of the tube. When the release tool is pressed against the fitting, the tube can simply be pulled out of the fitting.

Many types of fittings, valves and other assemblies are now available with push-on joints. One example is the ball valve shown in Figure 3-32.

Figure 3-32



At present, push-on fittings are primarily used in residential plumbing systems, rather than hydronic heating systems. They are more expensive than standard fittings such as those used for soldered joints. In some cases, they may not have the temperature and pressure ratings needed for higher temperature hydronic heating systems.

PRESSED JOINTS:

Another contemporary method of joining metal tubing is called a *pressed joint*. The concept is simple, but it relies on tools that can exert several thousand pounds of mechanical force uniformly around the fitting. This is well beyond what manually-operated tools are capable of providing.

Press fittings are made of copper, brass, steel and stainless steel. They all contain an internal O-ring that is seated within a raised channel on the fitting. Figure 3-33 shows a typical press fit elbow.

Figure 3-33



The tube to be joined to the fitting is cut square, deburred and inserted into the fitting until it contacts in internal stop. The outer surface of the tube is now in contact with the O-ring in the fitting.

A specialized tool with jaws that open to fit around the raised channel on the fitting is placed over the end of the fitting where the joint will be made, as seen in Figure 3-34.

Figure 3-34



The person making the joint pulls a trigger on the tool, which then slowly closes its jaws over the fitting. The tool is capable of exerting extremely high force on the fitting, which reshapes the original round shape of the fitting socket into a hexagonal shape, as seen on several pressed fittings in Figure 3-35.

As the joint is pressed, the O-ring is compressed against the outer surface of the tube, and the copper surrounding the O-ring is shaped so that it can withstand high pressure without allowing the tube to slide out of the fitting. The press tool automatically stops when sufficient force has been imparted to the joint. The jaws of the tool are then opened, allowing the tool to be removed.

Figure 3-35



The press connections offered on Caleffi products can also be made when water is trickling from the joint, which again rules out any type of soldering, brazing, welding or solvent welding. Small detents on the O-ring allow small amounts of water to flow through the joint prior to pressing. This helps ensure that installers don't forget to press all the joints.

Figure 3-36

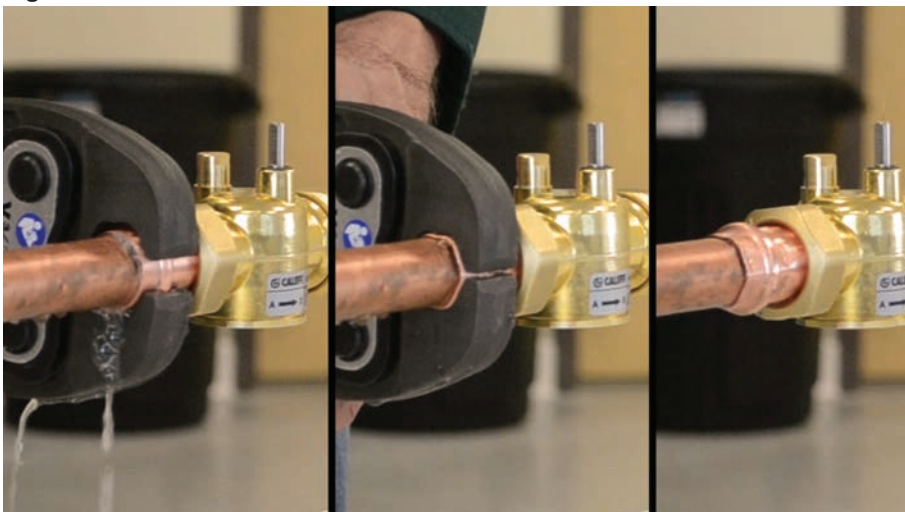

Press fittings have gained wide popularity in both the plumbing and hydronic trades. They require significantly less time and skill compared to soldering, brazing or welding. Although press fittings are more expensive than standard copper tube fittings, the time savings associated with their use typically counteracts their higher cost.

A wide variety of piping fittings and hydronic system components are now available with press connections. Figure 3-36 shows a zone valve with a press fitting tailpiece being joined to a copper tube. Note that the joint is being made with water initially leaking from the unpressed joint.

COMPRESSION JOINTS:

Another long-established method of joining copper tubing to other tubing or fittings is called a compression joint. Traditionally, compression joints were used on copper tubing. However, this method of joining has advanced for use with polymer tubing such as PEX and PVC. Compression joints for polymer tubes are discussed in section 4.

When used with copper tubing, the end of the tube must be cut square and deburred. It should also be

Figure 3-37



inspected for any dents or out-of-round damage. Such damage should be removed because it can cause the completed joint to leak.

The next step is to slide a compression nut over the tube. The compression nut has internal straight threads.

A precisely machined brass ring called a ferrule is then slipped over the end of the tubing. The ferrule has tapered surfaces on both ends and should fit snugly along the outer surface of the tube. Figure 3-37 shows a compression nut and ferrule near the end of a small copper tube.

The body of the compression fitting has external straight threads. It is pushed on the end of the tube until the tube bottoms out in the fitting. The compression nut and ferrule are then pulled up to meet this fitting. A pair of wrenches, one on the compression nut and the other on the compression fittings are used to tighten the nut to the fitting, as seen in Figure 3-38.

Figure 3-38



As the joint tightens, the tapered edges of the ferrule are pushed tightly against the outer surface of the tube, making the seal.

UNDERSINK COMPRESSION JOINTS:

There are several ways in which hot and cold domestic water piping connects to fixtures such as a lavatory faucet. A wide range of valves and hoses is available to adapt between different combinations of fixtures and hot/cold supply piping.

Older faucets often used 3/8-inch chrome plated brass tubes for hot and cold water supply. In these installations,

Figure 3-39



each supply tube was carefully bent so that it passed straight into a shutoff valve supplied with 3/8-inch compression hardware. A brass ferrule and compression nut, usually supplied with the shutoff valve, is used to seal the brass tube to the valve.

Modern faucets are often supplied with a transition fitting from the faucet tube that terminates with 1/2" male pipe threads. A variety of flexible hoses are available that provide a type of compression joint between the faucet supply tubes and the shutoff valve. One common type of flexible supply hose uses a 3/8-inch compression connection, as shown in Figure 3-39.

The end of this hose has an integrated elastomeric sleeve with tapered sides that seat directly against a 3/8-inch metal port equipped with external threads. When the compression nut on the hose is tightened, the elastomeric sleeve is compressed to form a seal.

Caleffi thermostatic mixing valves for point-of-use applications can be ordered with tailpieces that connect to these flexible hoses, as seen in Figure 3-40.

Figure 3-40



POLYMER PIPE JOINING METHODS & MATERIALS

During the 20th century, metal piping and fittings were used for nearly all pressurized piping systems. However, the 20th century was also a time when great progress was made in developing polymer materials such as polyethylene (PE), polypropylene (PP), polybutylene (PB) and polyvinyl chloride (PVC). Although these polymers were not originally used for pipe, they established a reputation for durability and ever-improving methods of production. Their resistance to corrosion and scaling, relative ease of installation, and lower cost in comparison to metal soon spurred development of polymer pipe and fittings.

Today, polymer piping is rapidly gaining market share against metal piping in applications such as domestic water supply, hydronic radiant panel heating, water well piping, natural gas distribution, and drainage waste & ventilation piping. Some polymer piping materials, such as cross-linked polyethylene (PEX) and high-density polyethylene (HDPE), are arguably the principal reason that specialized technologies such as radiant panel heating and geothermal heat pump systems even exist. Metal piping materials were previously used, to some extent, in both of these applications, but proved to be impractical, costly or unreliable.

POLYVINYL CHLORIDE TUBING (PVC):

One of the earliest types of polymer piping was polyvinyl chloride (PVC), originally discovered by a French physicist

in 1838, appearing as a “white solid” in flasks filled with vinyl chloride gas. In 1913, a German inventor discovered and patented a polymerization method for vinyl chloride, making it possible to produce it on an industrial scale. The durability of PVC when exposed to the elements caught the attention of several companies, including BF Goodrich, a few years later. Advancements in production led to its use as a fabric coating and for electrical insulation on wire. By the 1970s, methods for improving the temperature resistance of PVC had produced a material suitable for residential DWV piping. Today, PVC is widely used for many types of piping in residential, commercial and industrial buildings. Figure 4-1 shows 2” side schedule 40 PVC pipe and fittings installed for a washing machine drain and associated vent.

CHLORINATED POLYVINYL CHLORIDE TUBING (CPVC):

Chlorinated polyvinyl chloride is produced by adding chlorine to PVC. The chlorine increases the temperature resistance of the CPVC relative to that of PVC. CPVC was first introduced as a piping material in 1959. In addition to hot and cold water distribution in buildings, CPVC pipe has been extensively used for fire sprinkler systems since 1985.

CPVC tubing is available in sizes from 1/2-inch to 2-inch copper tube size, and in sizes from 1/2-inch to 24-inch in schedule 40 and 80 wall thicknesses.

HIGH-DENSITY POLYETHYLENE TUBING (HDPE):

One of the most common polymer piping materials is polyethylene. Within the scope of plumbing and hydronic systems, a high-density formulation of polyethylene, appropriately abbreviated as HDPE, is used for a wide range of applications, such as water supply, well piping, natural gas mains and services, and earth loops for geothermal heat pump systems. Figure 4-2 shows long continuous coils of 1-inch HDPE pipe being placed in a trench for a geothermal heat pump earth loop.

HDPE is a *thermoplastic* that can be melted when raised to temperatures in the range of 450°F to 500°F. This characteristic limits its use in hot water systems, especially those operating under pressure. It also allows for unique joining methods, such as butt fusion and socket fusion, both of which will be discussed later in this section.

HDPE is manufactured to ASTM F2619/F2619M-19 standards. It’s available in continuous coils of 1,000 feet or more, allowing for long runs without joints. Its smooth internal surfaces decrease flow resistance, which reduces pumping power relative to other types of tubing that is joined with fittings.

Figure 4-1



Figure 4-2



The material designation for HDPE pipe is based on ASTM F-412. An example is the designation PE3408. The letters “PE” refer to polyethylene. The 3 refers to a density class. The 4 refers to a classification for resistance to slow crack growth. The last two digits (08) refer to a pressure classification.

Just as steel piping is manufactured to different schedules (schedule 40, 80, 160, etc.), which represent wall thickness and associated pressure/temperature ratings, HDPE is manufactured to different “dimension ratios.” A dimension ratio (abbreviated as DR) is the ratio of the *outside diameter* of the pipe divided by its wall thickness. For example, a 3/4-inch DR7 HDPE pipe has an outside diameter of 1.050 inches and a wall thickness of 0.15 inches. 1.050 divided by 0.15 is 7. Standard diameter ratios are 7, 9, 11, 13.5, 15.5, and 17. The lower the DR value, the higher the pressure rating of the pipe. A DR7 HDPE pipe made of PE3408 resin, has a pressure rating of 267 psi at temperature of 73.4°F. A DR17 HDPE pipe made with the same resin has a pressure rating of 100 psi at the same temperature.

DR9 and DR11 HDPE pipe is widely used for cold water supply, water well piping, natural gas supply from mains to building, and earth loops for geothermal heat pump systems.

CROSS-LINKED POLYETHYLENE TUBING (PEX):

Abbreviated as PEX, cross-linked polyethylene tubing was developed in Europe in the 1960s. It was primarily used in hydronic radiant panel heating systems. PEX was introduced in North America in the early 1980s as

Figure 4-3

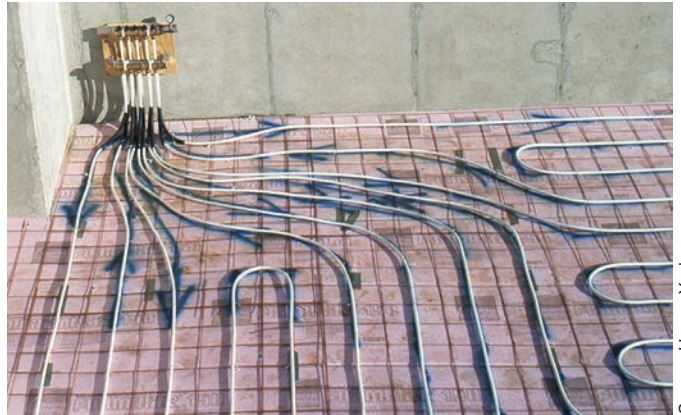

a reliable product for embedding in concrete slabs for radiant floor heating systems, as seen in Figure 4-3.

PEX is now extensively used in hydronic systems as well as potable water distribution systems in both residential and commercial buildings. Millions of miles of PEX tubing are now in service worldwide.

There are distinct differences between PEX and HDPE tubing. The polyethylene molecules in HDPE tubing are not bonded in a way that prevents movement as the HDPE approaches its melting point. At its melting point, HDPE liquifies and can be reformed into virtually unlimited shapes.

In contrast, cross-linking alters the relationship between adjacent polyethylene molecules by breaking carbon-hydrogen bonds and allowing them to reform into a three-dimensional crystalline structure. This *irreversible* process changes the polyethylene from a *thermoplastic* to a *thermoset plastic*. The resulting material offers significantly higher temperature resistance and pressure capability compared to HDPE.

Cross-linking also gives PEX tubing a “shape memory” characteristic. A piece of PEX tubing that has been severely kinked can be restored to its original shape by heating the tubing above its amorphous state (approximately 275°F) using a hot air gun, and then allowing it to cool. Heating allows the original three-dimensional crystalline structure that was deformed at the kink to be reestablished. The kinked area will return to its original (as manufactured) dimensions, without residual damage to the tubing. The shape memory characteristic is also the basis for several modern joining methods involving PEX tubing that are discussed later in this section. Unlike HDPE, PEX cannot be reformed or joined by heating to its melting point.

In North America, the PEX tubing used in hydronic systems and domestic water plumbing conforms to ASTM F876

and ASTM F877 standards respectively. Under these standards, PEX is standardized to copper tube sizes (CTS). It is designated by nominal (e.g., approximate) inside diameter, and has an outside diameter exactly 1/8-inch (0.125") greater than its nominal size. For example, a 1/2-inch PEX tube has an outside diameter of 5/8-inch (0.625 inches).

Under the ASTM F876/F877 standard, there are three temperature/pressure ratings for PEX tubing: 160 psi @ 73.4°F, 100 psi @ 180°F and 80 psi @ 200°F.

PEX tubing is readily available in nominal copper tube sizes from 5/16-inch through 4-inch, with even larger sizes, up to 5.5-inch, available for specialized applications, such as insulated underground piping in district heating systems. Smaller sizes of PEX tubing are typically available in coils up to 1,000 feet long.

A wide range of fittings and joining systems is also available for PEX tubing, allowing it to be easily adapted to other tubing materials, fittings, valves, and other components used in plumbing and hydronic systems.

OXYGEN DIFFUSION:

Oxygen diffusion is a characteristic shared by many types of polymer pipe, including HDPE, PEX, polybutylene (PB) and polypropylene (PP). It refers to the ability of free oxygen molecules, which are present nearly everywhere, to pass through the molecular structure of polymer pipe. The oxygen molecules move from areas of higher concentration to areas of lower concentration. This diffusion is temperature dependent (higher rates of diffusion at higher pipe temperatures), but relatively insensitive to the difference in pressure between the inside and outside of tubing used in hydronic system applications.

Experience has shown that the rate of oxygen diffusion through standard PEX tubing when used in hydronic systems can lead to significant oxidation of ferrous metals within the system. The oxidation can cause sludges to form, and also severely damage components such as cast iron circulators, steel expansion tanks and steel panel radiators.

Because of this issue, most of the PEX tubing used in modern hydronic heating applications is manufactured with a thin coaxial layer of EVOH (Ethylene Vinyl Alcohol). This material creates an "oxygen barrier" that greatly reduces the ability of oxygen molecules to diffuse through the tubing's wall. This type of tubing is commonly called "barrier" PEX, to distinguish it from "non-barrier" PEX.

The latter is commonly used in potable water plumbing applications. Most of the barrier PEX tubing used in hydronic system applications worldwide conforms to the DIN 4726 standard, which limits the rate of oxygen diffusion based on the size of the tubing (maximum diffusion rate of 0.10/m³/day at 104°F water temperature).

COMPOSITE PEX-AL-PEX TUBING:

Another type of tubing used in hydronic applications is a multi-layer composite consisting of inner and outer layers of PEX with a thin core layer of aluminum. These materials are bonded during manufacturing using specialized adhesives. The cross section of a PEX-AL-PEX tube is shown in Figure 4-4.

Figure 4-4

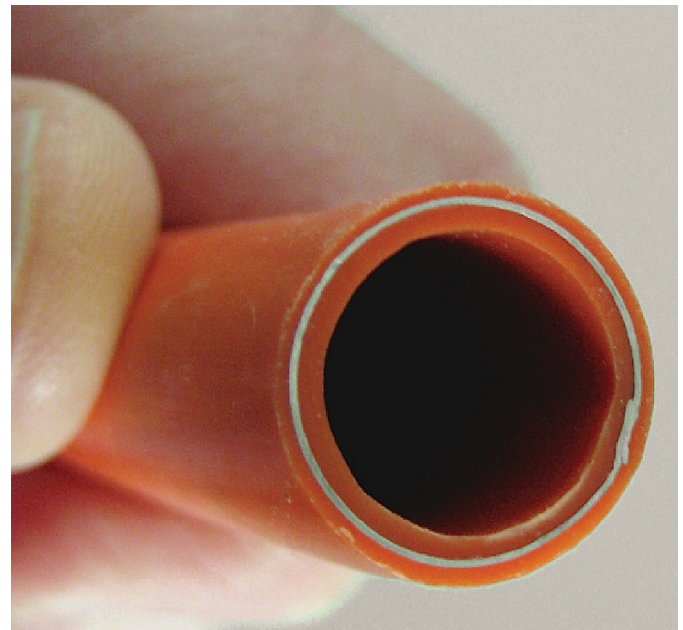

The aluminum core provides several benefits. It serves as an impermeable oxygen barrier. It also greatly reduces thermal expansion and contraction of the tubing in comparison to PEX tubing. The aluminum layer increases the temperature and pressure rating of the tubing relative to PEX and allows the tubing's position to be detected within embedded applications using inexpensive metal detectors. When bent, PEX-AL-PEX also retains its shape, which reduces the need for supporting clips relative to other types of flexible tubing.

In North America, PEX-AL-PEX is manufactured to ASTM F1281 standards. Under this standard, there are four temperature pressure ratings: 200 psi @ 73.4°F, 160 psi @ 140°F, 125 psi @ 180°F, and 115 psi @ 210°F. These ratings allow PEX-AL-PEX to be used in a wide range of

Figure 4-5



Courtesy of H. Youker

hydronic applications, including radiant panels, and as supply/return tubing to fin-tube baseboard and panel radiators that operate at relatively high supply water temperatures.

Due to its aluminum core, the change in length of PEX-AL-PEX tubing caused by changes in temperature is very similar to that of the aluminum heat transfer plates used in several types of radiant panels, such as the above-floor tube & plate installation shown in Figure 4-5. This characteristic reduces differential movement between the plates and tubing, which reduces the possibility for “ticking” sounds as the panels warm and cool.

POLYETHYLENE RAISED TEMPERATURE TUBING (PE-RT):

PE-RT tubing consists of high-density polyethylene that has undergone molecular modification that allows it to operate at higher temperatures than HDPE, but not as high as PEX or PEX-AL-PEX tubing. PE-RT has a 35-year history of use in Europe and was introduced in the U.S. in 2003.

PE-RT is manufactured to ASTM F2623 for hydronic system applications, and ASTM F2769 standards for potable water distribution use. Like PEX, it is available with an EVOH oxygen diffusion barrier for applications in closed-loop hydronic systems. In North America, PE-RT is made to the same copper tube sizes as PEX, and with a dimension ratio of 9 (e.g., outside tube diameter divided by wall thickness = 9).

The pressure/temperature ratings for PE-RT under ASTM F2623 are 160 psi@73.4°F, 100 psi@ 180°F and 80 psi @ 200°F. These ratings make PE-RT suitable for a wide range of plumbing and hydronic system applications.

Because it is *not cross-linked*, PE-RT tubing can be heated to a melting point and reformed. This characteristic allows for joining of tubing and fittings using socket fusion, as would be used with HDPE. It also allows scraps to be recycled. PE-RT also has greater flexibility than PEX tubing, allowing for tighter bends.

POLYPROPYLENE-RANDOM TUBING (PP-R):

Like polyethylene, polypropylene is a thermoplastic. It can be heated to a melting point and reformed, making it a recyclable material, as well as a material that can be joined by thermal fusion method (to be discussed later in this section). “Polypropylene random” describes specific chemical compositions of a base material (polypropylene) in combination with one or more comonomers. PP-R piping has its origins in Europe in the 1980s and has since been used in a wide variety of potable water, hydronic and specialty pipe applications worldwide.

The type of PP-R tubing commonly used in plumbing and hydronic systems typically has a reinforcing layer of glass fiber that is co-extruded with the polypropylene. This layer limits limit expansion and contraction movement due to temperature changes.

PP-R piping is manufactured to ASTM F2389-17a standards. PP-R tubing is rated to operate at temperatures up to 180°F, with corresponding pressure limits dependent on the diameter ratio (DR) of the tubing.

FUSION JOINING METHODS:

Several types of polymer tubing can be joined by heating the pipe, and in some cases the associated fittings of the same material, to their melting point, and bringing the semi-molten areas of these components together in a carefully controlled manner. This produces a homogenous joint where the original components are fused into a single piece of polymer. This technique is appropriately called fusion joining. It requires specialized tools for proper alignment and heating.

Four types of fusion joining methods are commonly used with thermoplastic (e.g., non-cross-linked) tubing such as HDPE, PE-RT and PP-R:

1. Socket fusion
2. Butt fusion
3. Saddle fusion
4. Electrofusion

SOCKET FUSION:

Socket fusion creates a bond between the outer surface of a thermoplastic tube and the inner surface of a fitting made of the same material. It is commonly used for fusing smaller sizes of polyethylene, PE-RT and PP-R tubing.

The tube and fitting to be joined are simultaneously pushed onto non-stick adapters bolted to each side of an electrically powered heating tool. One such tool is shown in Figure 4-6.

Figure 4-6



The adapters on each side of the tool simultaneously heat the outer surface of the tube and the inner surface of the fitting. The time required to properly heat the tube and fitting vary with the tube size, material and ambient temperature. Fusion tool manufacturers provide tables that give required heating times based on these parameters.

Figure 4-7



Once the required heating time has elapsed, the tube and fitting are pulled off the heating tool and immediately pressed together. Special tools called “cold ring clamps” are used to handle the hot tube, and control the alignment and depth of the fusion joint, as shown in Figure 4-7.

The joint must be held steady for several seconds to allow the molten surfaces to adequately cool and re-solidify. Once the joint has cooled, the tube and fitting are literally one piece of material. The joint is very strong and cannot be undone.

BUTT FUSION:

Straight lengths of some thermoplastic pipes can be joined together without the use of a coupling. The process is called butt fusion. The ends of each pipe are locked into a special tool called a butt fusion machine, which maintains exact centerline alignment, as shown in Figure 4-8.

Each pipe end is then “faced” using a rotary cutting tool that locks into the butt fusion machine so that the ends of the pipe are cut square. The two-faced end is then pressed against a heater tool, also seen in Figure 4-8.

Figure 4-8



Figure 4-9

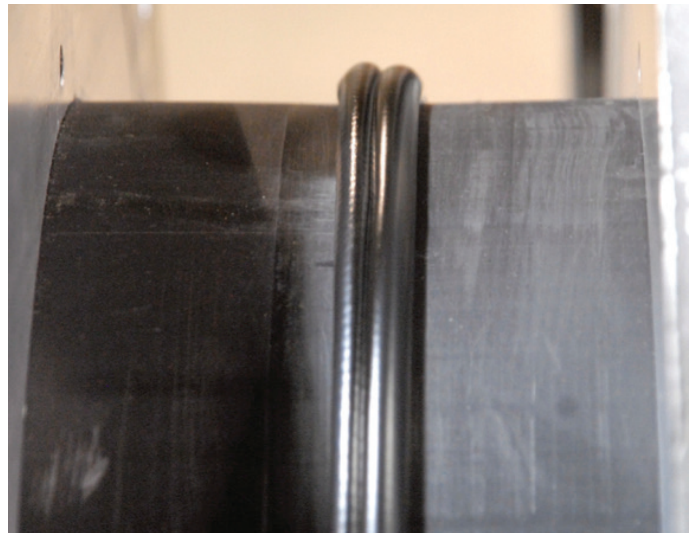

After sufficient heating to 450°F to 500°F, the two ends are semi-molten. The heater tool is quickly removed, and the two pipe ends are pressed together using the butt fusion machine to form a “double rollback bead,” as seen in Figure 4-9.

The cross section of a properly executed butt fusion joint is thicker than the pipe wall, and completely homogenous. As such, it is stronger than the pipe itself.

Butt fusion is commonly used to fuse HDPE pipe in natural gas service pipe, as well as in earth loops for geothermal heat pumps. It can also be used with PP-R and PE-RT tubing.

SADDLE FUSION:

It is possible to create branch connections in thermoplastic pipe without the use of a traditional tee fitting. The technique is called saddle fusion. As with socket fusion and butt fusion, specialized tools are required. One such tool cuts a precisely sized hole through the wall of the header tube and removes all cut material to the outside of the pipe. A heating tool with adapters that match the outside curvature of the pipe and that of the “saddle” fitting is placed between the pipe and saddle. When these surfaces are sufficiently heated, the heating tool is removed, and the saddle is pressed against the semi-molten area on the header pipe. Once cooled, the bond is homogenous and very strong. Figure 4-10 shows a cut-away sample of a saddle fusion joint created in PP-R

Figure 4-10



tubing. In this case, the saddle fitting was manufactured with an FPT threaded brass insert.

Figure 4-11 shows a manifold for a geothermal heat pump system that was made using saddle fusion fittings and PP-R tubing.

Figure 4-11



ELECTROFUSION:

Another type of fusion joining uses special fittings with embedded electrical heating wires. Two examples of such fittings are shown in Figure 4-12. The green fitting is made of polypropylene. The black fitting is made of polyethylene.

The end of the pipe to be joined to the fitting must be shaved with a special facing tool to remove any debris or films. The inside surface of the fitting is cleaned with methyl ethyl ketone (MEK) to remove any dirt or films. Following this preparation, both pipes to be joined are pushed into the fitting. The inserted pipes and the fitting are clamped into a fixture that ensures proper insertion depth and alignment. An electrical power supply, such as shown in Figure 4-13, is connected to the two electrodes on the fitting to provide low-voltage/high-amperage

Figure 4-12



Courtesy of VARI-TECH, LLC

power. The wires within the fitting quickly heat the HDPE to its melting point, and the outer surface of pipe is fused to the socket of the fitting.

Figure 4-13



Courtesy ritmo.it

CHEMICAL JOINING METHODS:

The most common method of joining PVC and CPVC pipe and their associated fittings is by solvent welding. The process begins by cleaning the end of the pipe and inside of the fitting with a rag to remove as much dirt and film as possible. The next step is to apply a “cleaner/primer,” which is a solution containing acetone, cyclohexane, and in some cases, tetrahydrofuran and methyl ethyl ketone. These solvents chemically clean the surfaces and soften the base material (e.g., PVC or CPVC). Some primers contain a purple die that provides evidence that the cleaner/primer has been applied, as seen in Figure 4-14.

Figure 4-14



Source: www.ewingirrigation.com

A liquid cement is then applied to the outer surface of the pipe and the inner surface of the fitting. The cement contains PVC resin which bonds to the pipe and fitting surfaces. After sufficient setting time, the solvents evaporate, leaving a homogenous PVC bond between the

pipe and fitting. Several cement formulations are available with different setting times, application temperature ranges, and compatibility with some materials other than PVC or CPVC.

MECHANICAL JOINING METHODS:

As with metal pipe, there are several mechanical methods for joining polymer piping. Some use traditional methods, which are the same as used on metal pipe. Others are contemporary techniques that leverage material properties, such as the shape memory of PEX tubing.

In the case of PVC and CPVC tubing, adapters are available with solvent weld connections on one side and MPT or FPT tapered threads on the other side. These adapters allow PVC and CPVC tubing to join to standard NPT threads on components such as valves, filters or water heaters.

When using threaded adapters on PVC or CPVC pipe, it is important to remember that PVC and CPVC will not withstand the same torque or shear forces as those used with metal pipe and fittings. Threaded connections on PVC or CPVC pipe should only be torqued to the extent necessary for a pressure-tight seal. This is especially important when using an FPT adapter made of PVC or CPVC. *It is not recommended to connect an FPT adapter made of PVC or CPVC to an MPT thread on a metal component.* The FPT adapter can be easily split as the metal MPT threads are tightened into it. The thermal expansion of PVC and CPVC is also greater than that of metal components. This can cause a joint using an FPT adapter made of PVC or CPVC tightened against a metal MPT thread to loosen as the joint warms while conveying hot water. For these reasons, such joints should be avoided.

CRIMP RING CONNECTIONS:

One of the simplest and least expensive methods for joining PEX and PE-RT piping uses a metal or engineered polymer insert fitting and a mechanically compressed steel or copper crimp ring, as shown in Figure 4-15.

Figure 4-15

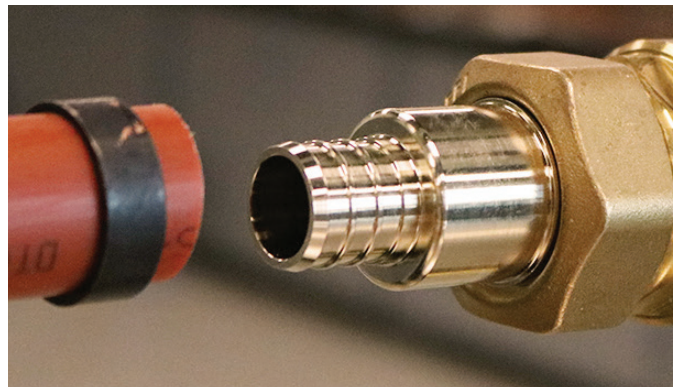
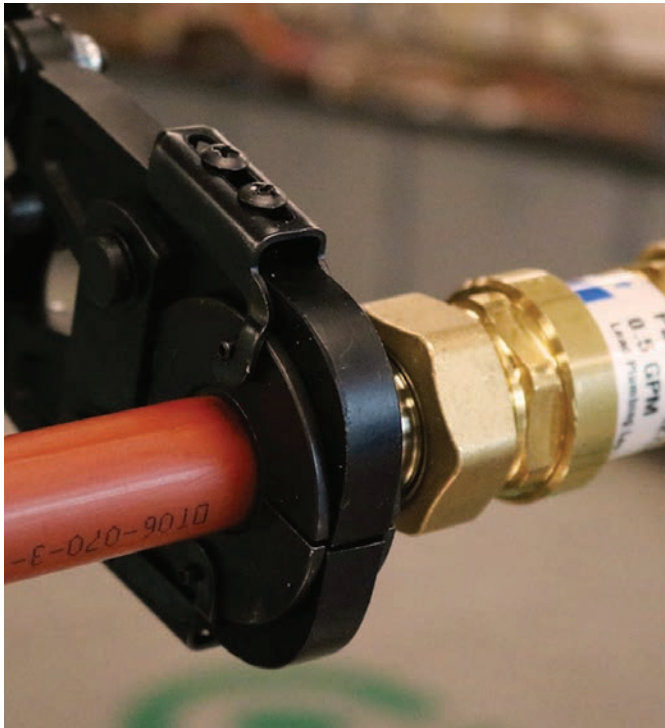

Figure 4-16



The insert fitting must be pushed all the way into the tube. The crimp ring is then moved just slight away from the edge of the tube. A specialized crimping tool that can generate high forces through mechanical leverage is placed over the crimp ring, as shown in Figure 4-16.

The handles of the tool are pressed together to crimp the ring against the tube wall to complete the joint. The integrity of the crimped ring can be checked using a “go/no go” gauge that measures the diameter of the crimped ring. Different-sized tubes require different dies to be used in the crimping tool. Crimped joints are simple, low cost and irreversible. They are widely used on smaller sizes of PEX tubing in domestic water distribution systems. The details for this type of connection are covered by ASTM standard F1807-19a.

CINCHED CONNECTIONS:

Another method for joining small-diameter PEX tubing relies on a stainless steel “cinch collar” rather than a crimp ring to create high compressive force between the inside of the tubing and an insert fitting. Figure 4-17 shows an example of a cinch collar over a PEX tube.

Cinch connections are made using an Oetiker-style pinch collar, which is mechanically compressed using a manually operated tool similar to that used for a crimp ring, but with a different attachment to the Oetiker clamp, as seen in Figure 4-18.

Figure 4-17



Figure 4-18



Being stainless steel, cinch rings are better suited than steel crimp rings to connections that may be repeatedly wetted due to condensation or other sources of moisture. Another advantage is that the same tool can be used for cinching different size Oetiker clamps for different tube sizes without changing dies or otherwise reconfiguring the tool.

The details for cinch connections on PEX tubing are also covered by ASTM standard F1807-19a.

CRIMP SLEEVE CONNECTIONS:

One method for joining pieces of PEX-AL-PEX tubing, or joining PEX-AL-PEX to fittings, uses a special fitting with an integral stainless steel sleeve and two internal O-rings. An example of such a fitting is shown in Figure 4-19.

Figure 4-19



The PEX-AL-PEX tubing is prepared by chamfering the inside surface of the tube using a special tool that slightly cuts back the inside PEX layer and the aluminum layer to leave a conical inner surface. This tool also “trues” the end of the pipe to ensure a consistent diameter. Chamfering decreases the force necessary to push the fitting onto the end of the tube. It also trims the aluminum layer back so that it does not touch the brass in the fitting.

Figure 4-20



After chamfering, the fitting is pushed onto the end of the tube until the latter bottoms out in the fitting. A manually operated or battery-powered crimping tool specifically designed for these fittings is used to compress the stainless steel sleeve on each side of both internal O-rings, as seen in Figure 4-20. The O-rings provide the pressure tight seal.

COLD-EXPANSION CONNECTIONS:

PEX tubing was previously described as having “shape memory.” When the original diameter of a PEX tube is partially expanded, the tube will return to its original diameter when the source of the expansion is removed. This property can be exploited in forming pipe connections using what is generically described as “cold-expansion” fittings.

A cold-expansion joint is made by slipping a reinforcing ring made of PEX over the end of the tube. A special hydraulic expander tool is then inserted into the end of the tube. The expander tool has a split-tapered mandrel with serrated faces. The latter prevents the mandrel from slipping off the tube as expansion takes place. The split surfaces of the mandrel move radially apart as

Figure 4-21



Figure 4-22

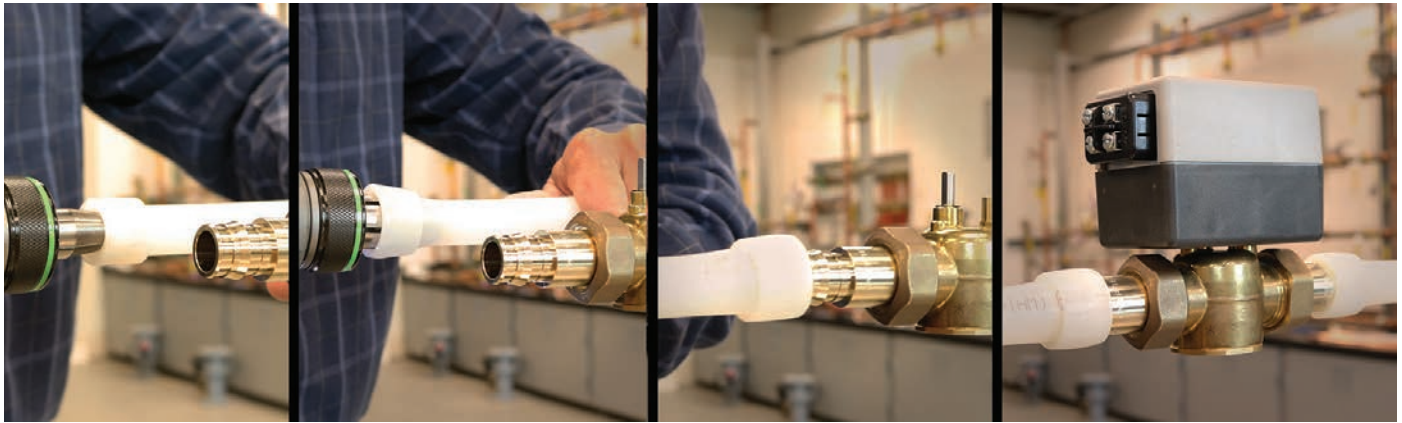

the expansion tool is operated. The expansion force is created by a tapered mandrel within the tool. Tools are available for manual operation or battery powered. The split-tapered mandrel expands the end of the PEX tube and the PEX reinforcing ring around the end of the tube. When the tube is sufficiently expanded, the expansion tool is released and quickly removed. An insert fitting made of brass or engineered polymer is immediately placed into the expanded end of the tube. Within a few seconds the shape memory of the tube and PEX reinforcing ring causes the tube to compress tightly against the insert fitting to form a permanent pressure tight joint capable of operating over the entire application range of PEX tubing.

Cold-expansion joining can also be used with PE-RT tubing, provided the reinforcing ring is PEX.

Figure 4-21 shows two insert fittings made of engineered polymer, along with a cold-expansion reinforcing ring. It's important to understand that fittings designed for cold-expansion joints are different from those intended for crimp or cinched joints.

Figure 4-22 shows a sequence of photos starting with the expansion tool inserted into the end of a PEX tube with a PEX reinforcing ring around the end of the tube. The expanded tube and ring are then pushed onto the brass fitting. Shape memory quickly causes the tube and reinforcing ring to grip the end of the brass fitting for a pressure tight joint.

Cold-expansion joining can also be used with PE-RT tubing that complies with ASTM F2769, provided the reinforcing ring is PEX. It can be used for non-barrier tubing, which is typically used in domestic water supply piping, as well as with barrier PEX tubing that complies with ASTM F3253, which is typically used in hydronic heating and cooling systems. Details for this method

of pipe joining are covered by the ASTM standard F1960-19 (*Standard Specification for Cold Expansion Fittings with PEX Reinforcing Rings for Use with Cross-linked Polyethylene (PEX) and Polyethylene of Raised Temperature (PE-RT) Tubing*).

Cold-expansion joints can be used on a wide variety of PEX tube sizes up to 3" nominal size. There is also a wide variety of adapter fittings and valves that are specifically designed for cold-expansion joining.

COLD-EXPANSION/COMPRESSION RING CONNECTIONS:

Another variant of cold-expansion joining uses a brass or engineered polymer reinforcing ring rather than a PEX reinforcing ring. The reinforcing ring is slipped over the end of a PEX tube. The end of the tube (but not the compression ring) is expanded using the same type of tool used with the PEX reinforcing ring system. When the tube is sufficiently expanded, the expansion tool is released and removed. An insert fitting is immediately pushed into the expanded end of the tube. Another tool, or the opposite end of a multipurpose expansion tool, is then used to pull the compression ring back over the end of the tube. This compresses the tube to create a permanent and pressure-tight joint.

Figure 4-23 show a sequence of steps where a multipurpose tool expands the end of a PEX tube, an insert fitting is set into the expanded end, and the opposite end of the expansion tool then pulls the compression ring back over the end of the tube.

Some cold-expansion joints are rated for burial in concrete slabs or in soil. In some cases, the joint needs to be wrapped with protective tape or a heat-shrink sleeve; in other cases, no tape or sleeve is necessary. Check with the fitting system manufacturer for specific requirements on embedded joints.

Figure 4-23a



Figure 4-23b



Figure 4-23c



Courtesy of REHAU

COMPRESSION FITTINGS FOR POLYMER PIPE:

Some types of polymer pipe can also be joined using wrench-tightened compression fittings. Examples include PEX-AL-PEX and PVC. The internal design of these compression fittings differs based on the type of tubing they are intended to be used to join. Figure 4-24 shows an example of a brass adapter designed specifically to joint PEX-AL-PEX tubing.

These fittings rely on a set of small O-rings positioned on the neck of a brass insert fitting. They also have a brass ferrule that slides over the outside of the pipe and a

Figure 4-24



compression nut with parallel treads. As the compression nut is tightened, the ferrule is compressed against the outside of the tube, and the O-rings are compressed against the inside of the tube. The seal occurs at the O-rings.

Figure 4-25 shows a similar compression fitting for PEX tubing, which also uses a ferrule but does not use O-rings on the neck of the insert. Instead the seal is made by compressing the inner surface of the PEX tube against multiple ridges on the brass insert.

Figure 4-25

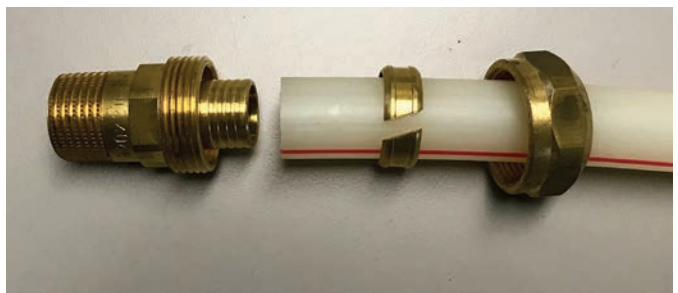

PUSH-ON FITTING JOINTS:

One of the newest methods for connecting polymer pipes to other pipes and fittings is called a “push-on” or “push-to-fit” fitting. It can be used on a variety of polymer pipes, including PEX, PEX-AL-PEX, PE-RT, PVC and CPVC. It can also be used with copper tubing or virtually any combination of copper and polymer tubing. It is one of very few fittings that can be installed without tools, making it a popular choice for do-it-yourselfers who need to make minor repairs or modifications to existing

plumbing systems. It is especially helpful in situations where water is trickling from a pipe at the location where a joint is needed. That situation precludes using soldering, brazing or solvent welding. The ability of push-on fittings to accept different types of tubing at each end of the fitting also makes it possible to repair or modify an existing copper plumbing system using PEX or PVC tubing without need of specialized tools or bonding materials.

Figure 4-26 shows a cut-away view of a push-on fitting.

To make a connection, the end of a tube is cut square and pushed into the fitting until the end of the tube contacts the tube stop. As the tube passes into the fitting, it slides past a seated stainless steel ring that has several sharp teeth angled toward the center of the fitting. The tube also passes through an O-ring. Because of their angle, sharpness and spring temper, the stainless steel teeth press against and slightly penetrate the outer surface of the tube. This action prevents the tube from being pulled backward out of the fitting. When the joint is put under pressure, the “holding power” of these teeth increase as the pressure increases. With the tube restrained within the fitting, the seal is made at the O-ring.

Figure 4-26



If necessary, the tube can be removed from the fitting using a plastic “release tool” that snaps over the tube. The release tool is pushed against the neck of the push-on fitting. The neck moves slightly into the fitting and temporarily lifts the gripping teeth above the outer surface of the tube. When the release tool is pressed against the fitting, the tube can be pulled out of the fitting.

BARB & CLAMP JOINTS:

High-density polyethylene (HDPE) is often used in low water temperature applications such as water wells and geothermal heat pump systems. In these systems, the HDPE often has to be joined to metal components such as a 1-inch FPT threaded connection on a heat pump. Such joints can be made using metal or CPVC adapter

fittings having NPT pipe threads on one port and a “barbed” geometry on the other port. An example of such a fitting is shown in Figure 4-27.

Figure 4-27



The barbed end of this fitting has four tapered rings, each with a sharp edge on its outer perimeter. This end of the fitting is pushed into the end of an HDPE pipe. The sharp edges of the barbs press against the inside surface of the pipe. The joint is completed by tightening one or two stainless steel hose clamps around the outside of the pipe over the area where the barbs press against the inside of the pipe. The pressure exerted by the clamps creates a tight seal at the outer edge of the barbs. Figure 4-28 shows a completed barb and clamp joint connecting 1-inch HDPE pipe to a 1-inch threaded ball valve.

Figure 4-28



**SUMMARY:**

Those who design or install plumbing and hydronic systems have a wide range of piping materials and joining systems available to them. Traditional methods such as soldered and threaded joints are still extensively used in both plumbing and hydronic systems, especially where higher pressures and temperatures are required. However, traditional methods are also being challenged by many contemporary materials and joining systems, such as copper tubing joined by press fittings or PEX tubing joined by cold expansion. Contemporary methods often speed installation time and require less skill on the part of the installer. Some require specialized tools that can cost several hundred dollars, while others are as simple as pushing the end of a tube into the fitting.

This issue of *idronics* has summarized both traditional and contemporary methods and materials. Plumbing and heating professionals should be familiar with all of these options and their strengths, limitations and temperature/pressure ratings, to allow for informed and appropriate selections for each job.





Series 6000 LEGIOMIX® Family High Performance DHW Temperature Control

- Market's highest rated flow capacity.
- Automatically self-cleans to prevent scale formation.
- Flanged and NPT, press or sweat union connections.
- Easy to use digital interface includes data logging, alarming, and status indication.
- Selectable automatic scheduling to thermally disinfect system.
- Optional Modbus-to-BACnet gateway for BAS integration.



Controlling and protecting your water

www.caleffi.com - Milwaukee, WI USA

CALEFFI
Hydronic Solutions



Press Connections Available on our most popular products

- Years of proven Caleffi reliability in plumbing and hydronic product applications.
- Exclusive LEAK DETECTION feature reveals leakage point during system testing if a connection remains un-pressed.
- Versatile union connections feature integral copper tail-piece construction.



Heating & Cooling

Components for today's modern hydronic systems

CALEFFI
Hydronic Solutions

www.caleffi.com - Milwaukee, WI USA



Cold-Expansion PEX Fittings Available on our most popular products

- Low-lead, dezincification resistant brass alloy for durability.
- Union fittings for fast and easy installation and service.
- Meets the requirements of ASTM F1960 for cold-expansion fittings.



Heating & Cooling

Components for today's modern hydronic systems

www.caleffi.com - Milwaukee, WI USA

CALEFFI
Hydronic Solutions