

Radiant heating and cooling



**TECHNICAL
CATALOGUE**



You Feel, We Care

*is our new tagline
and contains a renewed promise:
to work every day
with commitment and passion
while offering **tangible benefits**.*

*And we do this by developing systems
which are able to ensure
comfort and health
as well as a pleasant living space.*

*We continue to follow the principles
that have always inspired us :
the use of the **best materials**,
the research for **advanced technologies**,
and a **specialized service** for design,
technical assistance and training.*

*These are the same reasons
that guided us in
identifying the
perfect comfort system.*

*In our solution four elements
(surface heating/cooling, air handling,
temperature control, heat pumps)
interact synergistically
to spread in every room
the **ideal living conditions**,
in which our skin can perceive
a unique **feeling of wellbeing**.*



Table of Contents

CEILING AND WALL SYSTEMS **PAG 04**

b!klimax Air+ **PAG 06**

b!klimax+ with plasterboard **PAG 14**

b!klimax 8+ with plasterboard **PAG 22**

Traditional b!klimax **PAG 30**

b!klimax+ Twin Copper **PAG 38**

b!klimax+ Copper 8 **PAG 42**

b!klimax+ Quadrotti HP **PAG 49**

b!klimax+ Quadrotti **PAG 56**

Accessories for b!klimax systems **PAG 68**

UNDERFLOOR RADIANT SYSTEMS WITH LOW THERMAL INERTIA **PAG 76**

Super D17 **PAG 80**

Super D **PAG 86**

Level Zero AD **PAG 92**

e-Dry Tech **PAG 98**

e-Dry Evo **PAG 104**

TRADITIONAL UNDERFLOOR RADIANT SYSTEMS **PAG 110**

Cover HP **PAG 114**

Cover **PAG 120**

Acoustic Plus **PAG 126**

AcuRapid **PAG 132**

Smooth Cover HP **PAG 138**

New Plus *PAG 144*

T50 *PAG 150*

TF-B HP *PAG 156*

MANIFOLDS, PIPES AND COMPLEMENTS **PAG 162**

Manifolds *PAG 164*

Piping *PAG 173*

Other complements *PAG 180*

Acoustic insulation for substrates *PAG 182*

Additives *PAG 184*

THERMOREGULATION DEVICES **PAG 186**

GM and GR mixing and booster units *PAG 188*

Mixing Box *PAG 209*

Standard Kit *PAG 213*

INDUSTRIAL UNDERFLOOR RADIANT SYSTEMS **PAG 224**

Industrial shaped panel *PAG 226*

PVC bars *PAG 230*

Industrial mesh *PAG 234*

Complements for industrial underfloor radiant systems *PAG 238*



**Ceiling and wall
radiant systems**

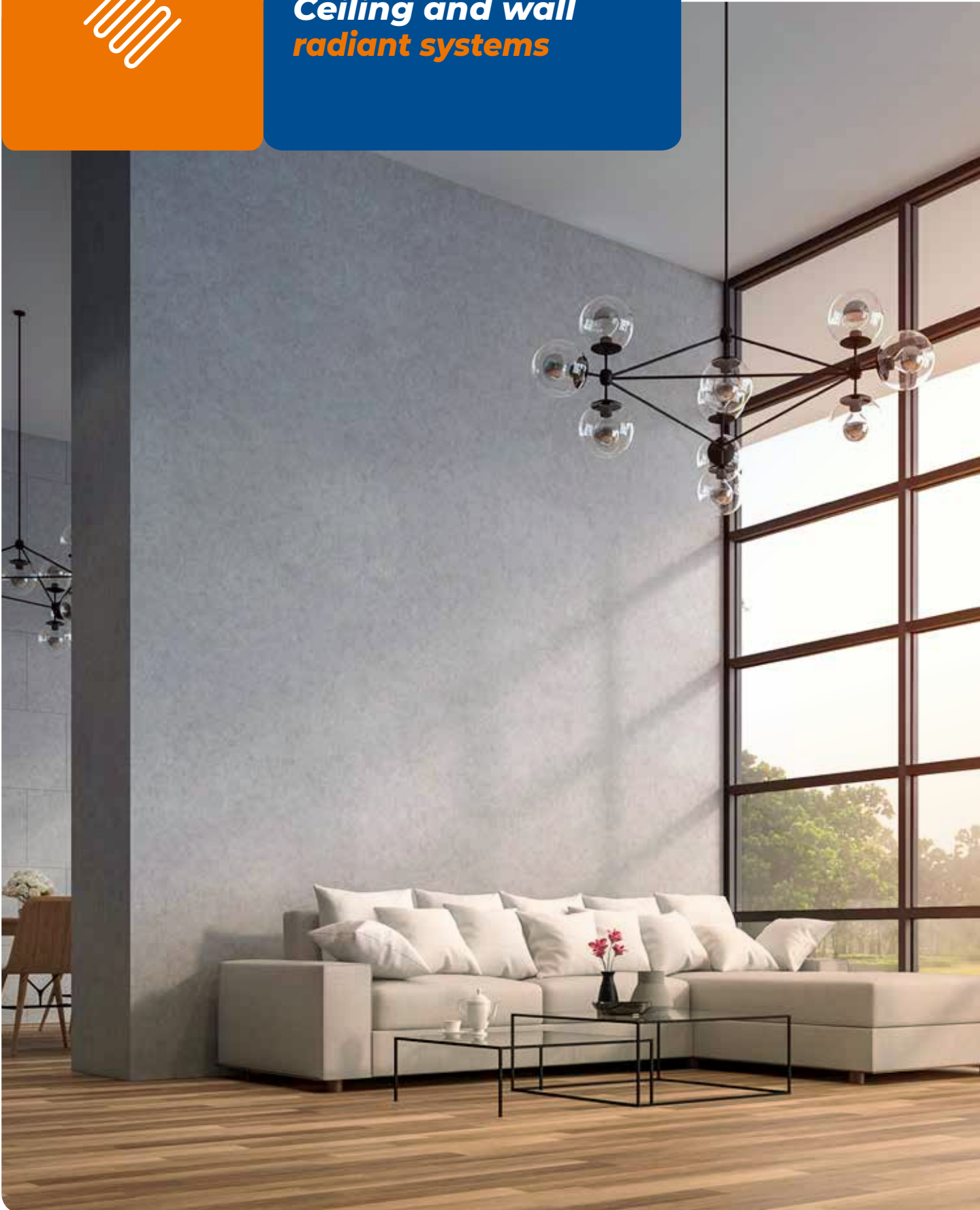



Widespread well-being

b!klimax is a heating and cooling system that exploits the ability of the ceilings and walls to exchange heat and cold through radiation with the room and with people. Thanks to the perfectly balance of the thermal exchanges, the human body perceived comfort is improved.

Available in different variants with metal, plasterboard or fibre-reinforced plaster finish, b!klimax provides the ideal climate in any building in the residential and commercial applications, either new or renovated.

In particular, it's indicated in situations where the lack of space makes it difficult to install a underfloor radiant system, for buildings with high room heights or for rooms where you want to preserve the existing flooring.

Invisible, responsive and easy to install, it offers high comfort in both summer and winter, healthy rooms, clutter-free spaces and maximum energy savings.

ADVANTAGES OF B!KLIMAX CEILING AND WALL SYSTEMS:



**INVISIBLE, COMFORTABLE
AND EFFICIENT**



**IDEAL FOR BOTH
HEATING AND COOLING**



**LOW THERMAL
INERTIA**



**ABSENCE OF
INVASIVE INTERVENTIONS**



**THERMALLY INSULATING
THE CEILING OR WALLS**



b!klimax Air+ is a room heating and cooling system that uses ceilings and walls as radiant surfaces. Invisible, comfortable and healthy, it provides the ideal room climate along with cleaner, healthier air.

The central element of the system is the polystyrene or rockwool radiant panel equipped with 4 hydraulic circuits \varnothing 6 mm and complete with a special plasterboard sheet capable of capturing and neutralising indoor pollutants.

The system is completed by the manifold, the distributors, the fittings, the \varnothing 20 mm polybutylene pre-insulated pipe for connecting the distributors to the manifold and the \varnothing 6 mm polybutylene pre-insulated pipe for connecting the panels to the distributors.

Designed to be installed on common metal structures for false ceilings, b!klimax Air+ does not require any invasive intervention and allows to exploit the gap between the ceiling and the radiant panels for the installation of other systems.

FEATURES

- Minimum recommended installation height 12 cm
- Ceiling or wall installation
- Low thermal inertia
- Finishing with special plasterboard sheet capable of reducing the concentration of indoor pollutants
- Installation on metal structure with 30 cm wheelbase
- Insulation in polystyrene or rockwool
- Suitable for residential and commercial application (schools, offices, hotels, hospitals, public buildings,...)



SECTION OF THE SYSTEM

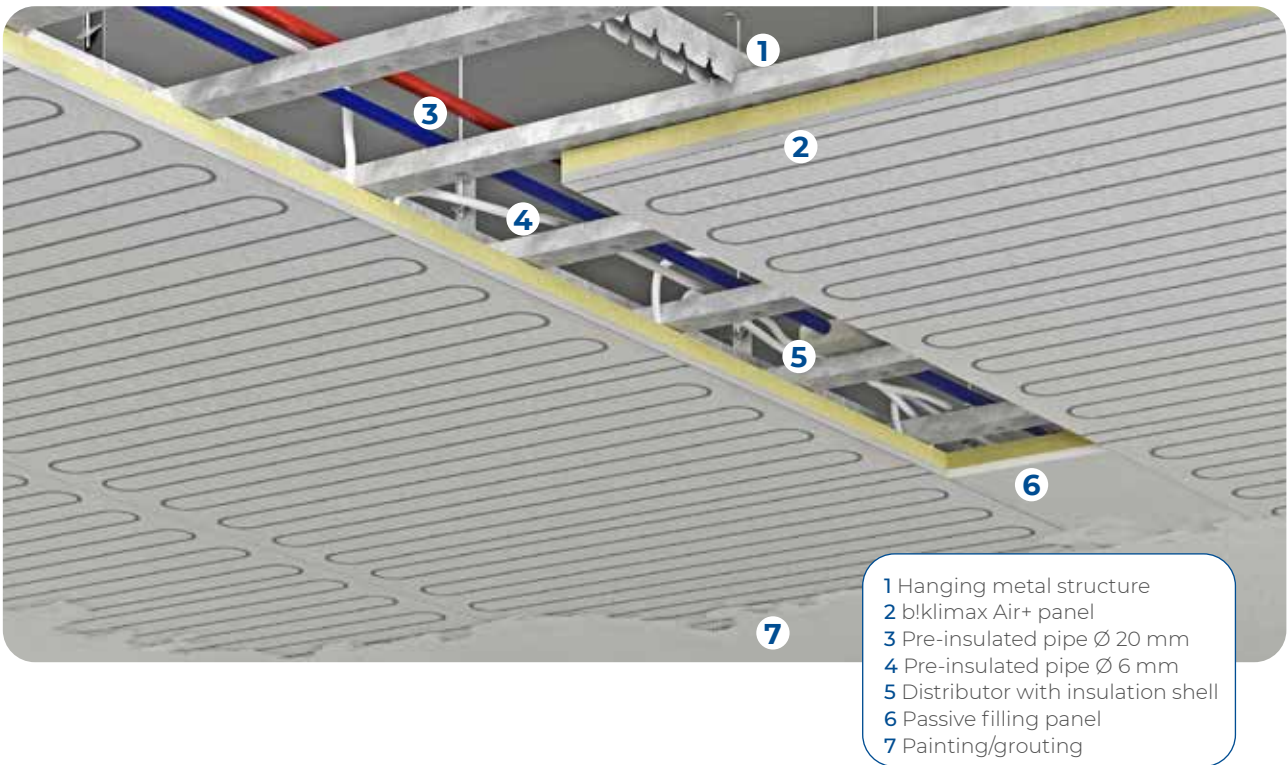

- 1 Hanging metal structure
- 2 b!klimax Air+ panel
- 3 Pre-insulated pipe Ø 20 mm
- 4 Pre-insulated pipe Ø 6 mm
- 5 Distributor with insulation shell
- 6 Passive filling panel
- 7 Painting/grouting

METAL SUPPORT STRUCTURE

b!klimax Air+ radiant panels are designed to be installed both on walls and ceilings on common double metal frame structures for dry systems, available on the market. Depending on the height of the rooms, it is possible to modulate the height of the pendant hooks according to specific requirements (aesthetic, based on the need to pass the ducts for other systems, etc.).

Hanging structure with snap profile

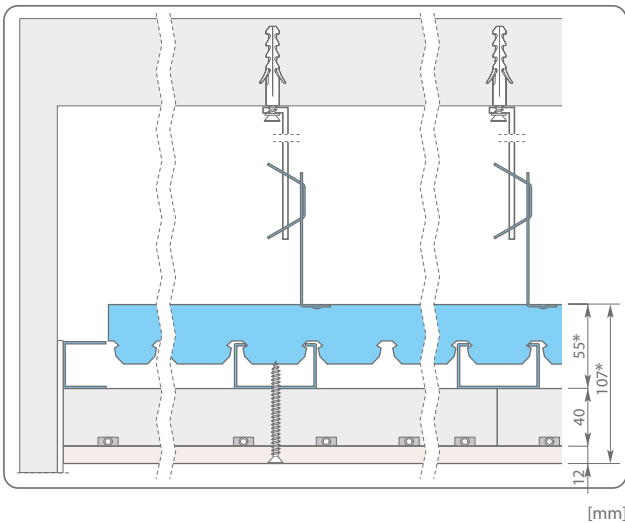

Structure with snap profile

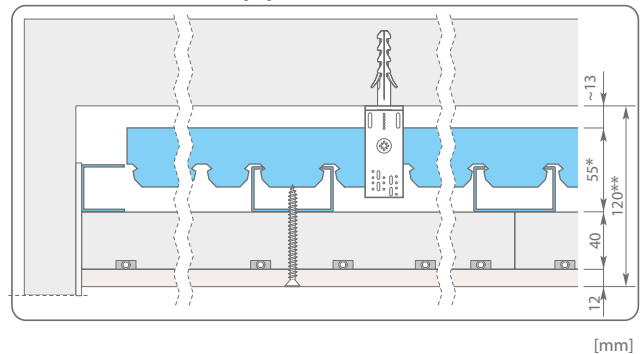

* Variable dimension depending on the profile used.

** If possible, to facilitate installation, we suggest a minimum height of 150 mm.

PRODUCTS THAT COMPOSE THE SYSTEM

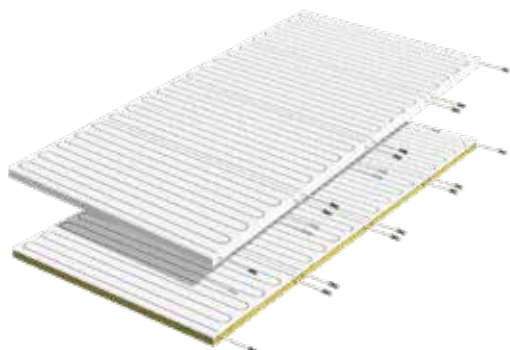

Panel features

Dimensions: 1200x2400x52 mm

INSULATION	WEIGHT	CODE
Polystyrene	33.1 Kg	6143114
Rockwool	51.5 Kg	6143115

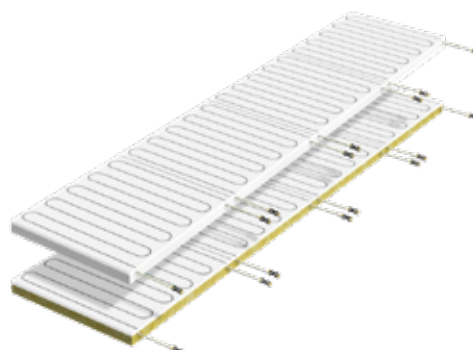

Panel features

Dimensions: 600x2400x52 mm

INSULATION	WEIGHT	CODE
Polystyrene	16.5 Kg	6143169
Rockwool	25.7 Kg	6143170

b!klimax Air+ panel

This radiant panel consists in extra white plasterboard which is able to absorb indoor pollutants. The panel includes 4 hydraulic circuits, made of pipe Ø 6 mm, provided with push-fit fittings and oxygen barrier according to DIN 4726. Pipes are fixed to the panel through an aluminium metal diffuser. Available with polystyrene and rockwool (fire reaction class: A1) insulation.

Plasterboard sheet characteristics	600	1200	Unit	Standard
Size	600x2400	1200x2400	mm	
Standard thickness	12.5		mm	
Density	870		Kg / m ³	
Fire reaction	A2-s1,d0			
Thermal conductivity	0.21		W / (m · K)	
Water vapour diffusion	(dry) 10	(humid) 4	μ	EN 10456

Polystyrene insulation characteristics	600	1200	Unit	Standard
Size of insulating panel	600x2400	1200x2400	mm	UNI EN 822
Standard thickness	40		mm	UNI EN 823
Insulation base thickness	34		mm	UNI EN 1264-3
Equivalent total thickness	38.6	38.8	mm	UNI EN 1264-3
Bending strength	BS	170	kPa	UNI EN 12089
Compressive stress at 10% deformation	CS(10)	120	kPa	UNI EN 826
Thermal conductivity 10 °C	λd	0.035	W/(m · K)	UNI EN 12667
Thermal resistance	Rd	1.10	(m ² · K)/W	UNI EN 12667
Thermal transmittance	U	0.90	W/(m ² · K)	
Water vapour diffusion resistance factor	μ	30 ÷ 70		UNI EN 12086
Water vapour permeability	δ	0.009 ÷ 0.020	mg/(Pa · h · m)	UNI EN 12086
Dimensional stability at 48h and 70 °C	DS(70,-)	1	%	UNI EN 1604
Long term water absorption by partial immersion	Wlp	0.5	Kg / m ²	UNI EN 12087
Long term water absorption by total immersion	WI(T)	≤3	%	UNI EN 12087
Fire reaction	Euroclass	E		EN ISO 11925-2
Limit of operating temperature		70	°C	
Declaration according to UNI EN 13163	T1-L3-W2-S2-P5-BS170-CS(10)120-DS(70,-)1-WL(T)3-MU(30-70)			

Rockwool insulation characteristics		600	1200	Unit	Standard	
Size of insulating panel		600x2400	1200x2400	mm	UNI 822	
Standard thickness		40		mm	UNI 823	
Declared thermal conductivity	λ_d	0.040		W/(m · K)	UNI EN 12667, 12939	
Thermal resistance	Rd	1		(m ² · K)/W		
Resistance to compression 10%	σ_{10}	70		kPa	UNI EN 826	
Resistance to point load	F _p	600		N	UNI EN 12430	
Tensile bond strength	σ_{mt}	15		kPa	UNI EN 1607	
Water vapour diffusion resistance factor		1			UNI EN 12086	
Short term water absorption by partial immersion		Ws		< 1	kg/m ²	EN 1609
Long term water absorption by immersion		Wl(p)		< 3	kg/m ²	EN 12087
Specific heat		C _p		1030	J / (KgK)	UNI EN 10456
Density		ρ		165	Kg / m ³	UNI EN 1602
Fire reaction		Euroclass		A1		UNI EN 13501-1
Declaration according to UNI EN 13162		MW-EN 13162 T5-CS(10/Y)70-PL(5)600-TR15-DS(TH)-DS(T+)-MU1-WS-WL(p)				

PE-HD-Xc pipe characteristics								
Outside diam. (mm)	Thickness (mm)	S-value	SDR-value	CLASS 4		CLASS 5	Water content (l/m)	
6	1	2.5	6	Tmax 60 °C	10 bar	Tmax 80 °C	10 bar	0,013

S = nominal pipe serial number according to ISO 4065, SDR = standard dimension ratio, allocation of SDR values, according to DIN 16893 and/or DIN EN ISO15875-2

Technical data of PE-HD-Xc pipe		Value	Unit	Standard	
Degree of cross-linking	23°C	≥ 60	%	DIN 16892	
Density	23°C	≈ 0.94	g/cm ³	DIN 16892/DIN 53479	
Flexural impact strength accord. to Charpy	23°C	no failure	kJ/m ²	DIN EN ISO 179-1/2	
Tensile strength	23°C	24 ÷ 30	N/mm ²	DIN EN ISO 6259-1	
Tenacity	23°C	24 ÷ 26	N/mm ²	DIN EN ISO 6259-1	
Elongation at break	23°C	400 ÷ 600	%	DIN EN ISO 6259-1	
Elastic modulus	23°C	600 ÷ 800	N/mm ²	DIN 16892/DIN EN ISO 128	
Stress crack resistance		no failure		ASTM D 1693	
Moisture absorption		< 0,01	mg (4d)	DIN EN ISO 62	
Coefficient of linear expansion		0°C – 70°C	1,5 · 10 ⁻⁴	1/K	DIN 16892 / DIN 53752
Thermal conductivity			≤ 0,41	W/(K · m)	DIN 16892 / DIN EN 12664
Smallest bend radius			≥ 5 · D	mm	DIN 4726
Oxygen tightness		40°C	≤ 0,32	mg/(m ² · d)	DIN 4726

Air+ blank panel

Blank panel made of extra white plasterboard which is able to absorb indoor pollutants. This panel is used to fill the area which is not covered with radiant panels and the area where distributors are installed. It can be cut according to the actual requirements.

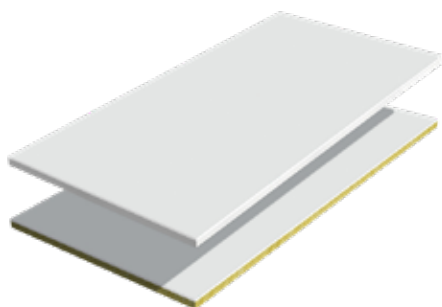

Panel features

Dimensions: 1200x2400x52 mm

INSULATION	WEIGHT	CODE
Polystyrene	34.5 Kg	6143124
Rockwool	50.8 Kg	6143125



Pre-insulated pipe Ø 20 mm

PB pipe with oxygen barrier according to DIN 4726 EN 12319-2, Ø 20 mm, pipe insulation made of expanded polyethylene, thickness 6 mm. Reaction to fire class: BL-s2, d0. It is used to connect distributors with b!klimax manifolds.

TYPE	SIZE	CODE
red roll 50 m	Ø 20 mm	6200020
blu roll 50 m	Ø 20 mm	6201020
red 1 bar 4 m	Ø 20 mm	6202020
blu 1 bar 4 m	Ø 20 mm	6203020

Note:
for further technical data see page 72



8-way Distributors

Pair of distributors made of plastic, specially shaped to guarantee easy connection with the pipes coming from b!klimax panels. These distributors are provided with anticondensation shells made of polystyrene or expanded polyethylene BL-s1, d0, push-fit pipe fittings for pipes Ø 6 mm and Ø 20 mm, and closing plastic bands.

MODEL	INSULATION	CODE
8-way open	polystyrene	6210040
8-way open	polyethylene	6210041
8-way terminal	polystyrene	6210050
8-way terminal	polyethylene	6210051



4-way Distributors

Pair of distributors made of plastic, specially shaped to guarantee easy connection with the pipes coming from b!klimax panels. These distributors are provided with anticondensation shells made of polystyrene or expanded polyethylene BL-s1, d0, push-fit pipe fittings for pipes Ø 6 mm and Ø 20 mm, and closing plastic bands.

MODEL	INSULATION	CODE
4-way open	polystyrene	6210060
4-way open	polyethylene	6210061
4-way terminal	polystyrene	6210070
4-way terminal	polyethylene	6210071



Straight Push-fit Fitting Ø 6 mm

Straight push-fit fitting used as connection for polybutylene pipes Ø 6 mm or Ø 20 mm. It's provided with anticondensation insulation shells available in polystyrene or polyethylene BL-s1, d0.

SIZE	INSULATION	CODE
Ø 6 mm	polystyrene	6510006
Ø 6 mm	polyethylene	6510016
Ø 20 mm	polyethylene	6510026



TEE Push-fit Fitting 20-20-20 mm

TEE push-fit fitting used as connection for PB pipes Ø 20 mm. It's provided with anticondensation insulation shells available in polystyrene or polyethylene BL-s1, d0.

SIZE	INSULATION	CODE
Ø 20 mm	polystyrene	6510055
Ø 20 mm	polyethylene	6510056



Cross Push-fit Fitting 20-20-20 mm

This cross push-fit fitting is used as connection for polybutylene pipes Ø 20 mm. It's provided with anticondensation insulation shells available in polystyrene or polyethylene BL-s1, d0.

SIZE	INSULATION	CODE
Ø 20 mm	polystyrene	6510065
Ø 20 mm	polyethylene	6510066



Elbow Push-fit Fitting 20-20 mm

This ELBOW push-fit fitting is used as 90° shifting for polybutylene pipes Ø 20 mm. It's provided with polyethylene BL-s1, d0 insulation or without it.

SIZE	INSULATION	CODE
Ø 20 mm	- -	6510075
Ø 20 mm	polyethylene	6510076

PRODUCTS THAT COMPOSE THE SYSTEM



Pre-insulated PB Pipe Ø 6 mm

PB pipe Ø 6 mm with oxygen barrier according to DIN 4726 EN 12319-2, pipe insulation made of expanded polyethylene, reaction to fire class BL-s1,d0, thickness 6 mm. It is used to connect b!klimax+ and Quadroto panels to the distributors.

SIZE	CODE
Ø 6 mm	6210006

Note:
for further technical data see page 73



Lubricant for Push-fit Pipe Fittings

This lubricant is used to guarantee better insertion of the pipes into the fittings and better preservation of O-rings. (1 package every 75 circuits).

SIZE	CODE
20 ml	6603000



Closing Plugs for Outlets Ø 6 mm and Ø 20 mm

Plastic plugs are used to close the unused outlets in a distributor.

SIZE	CODE
Ø 6 mm	6510040
Ø 20 mm	6510050



Industry System Elbow

Elbow for 90° shifting with pipes Ø 20 mm.

SIZE	CODE
Ø 20 mm	1140025



70-mm Fixing Screws

70-mm screws to fix b!klimax+ panels with plasterboard to the metal grid.

SIZE	CODE
70 mm	6510010



b!klimax Perimeter belt

Edge insulation for b!klimax and b!klimax+ ceiling systems, made of closed-cell expanded polyethylene. It acts as thermo-acoustic insulation and it absorbs plasterboard ceiling expansions.

SIZE	CODE
h 150 mm	6603010



Spare parts kit

Replacement kit for b!klimax fittings and distributors including all the components needed to restore a pipe connection.

SIZE	CODE
for Ø 6 mm pipe	6510070
for Ø 20 mm pipe	6510080

THERMAL OUTPUT OF THE SYSTEM

Thermal output in heating - ceiling

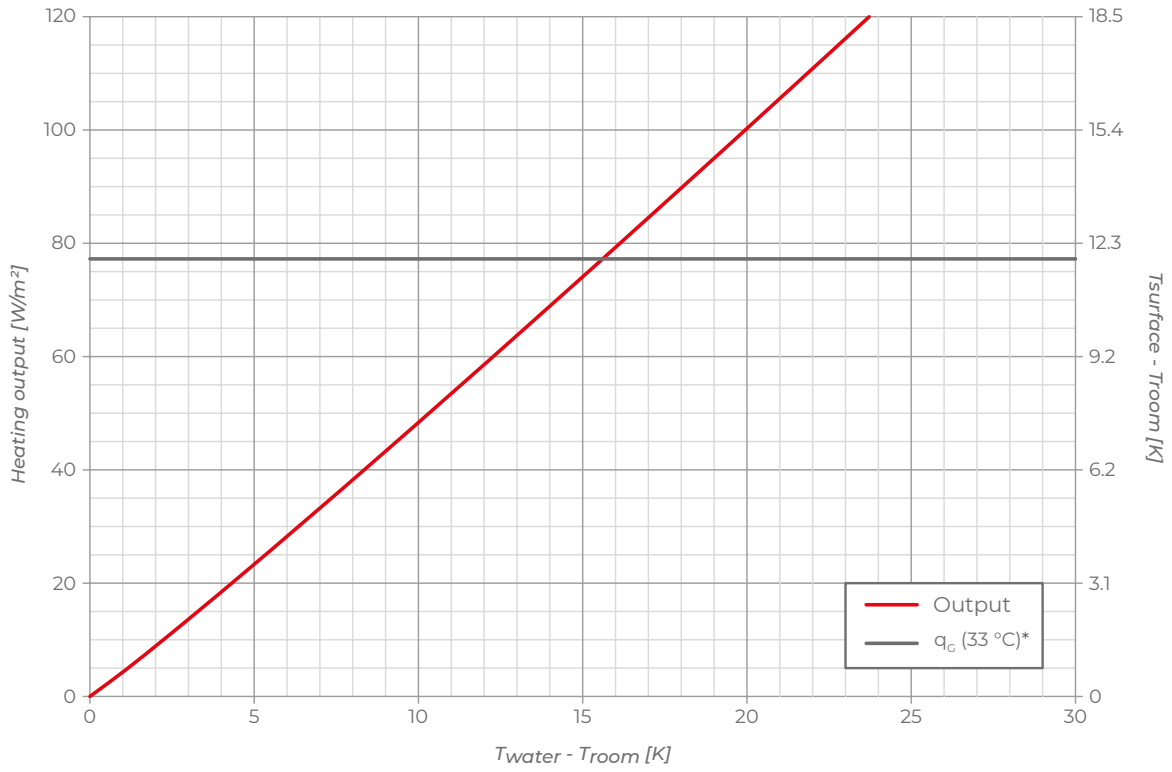

*valid only for room temperature= 20 °C

Thermal output in heating - wall

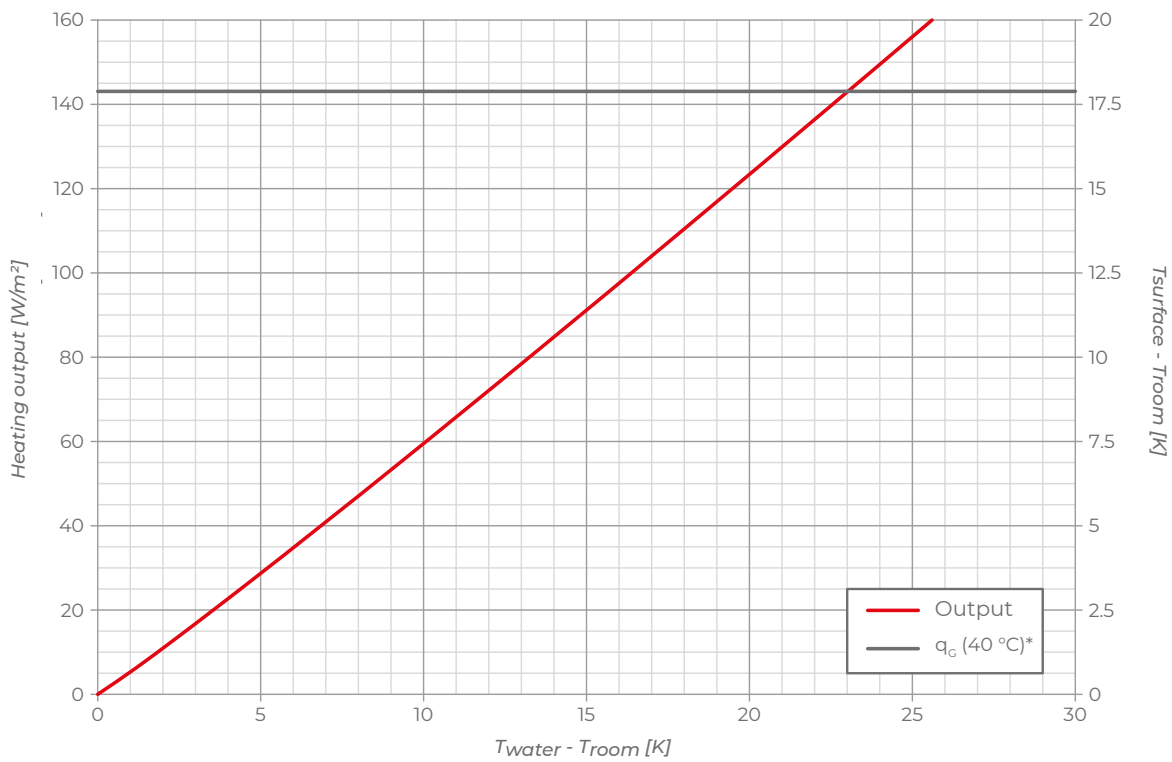

*valid only for room temperature= 20 °C

Thermal output in cooling - ceiling

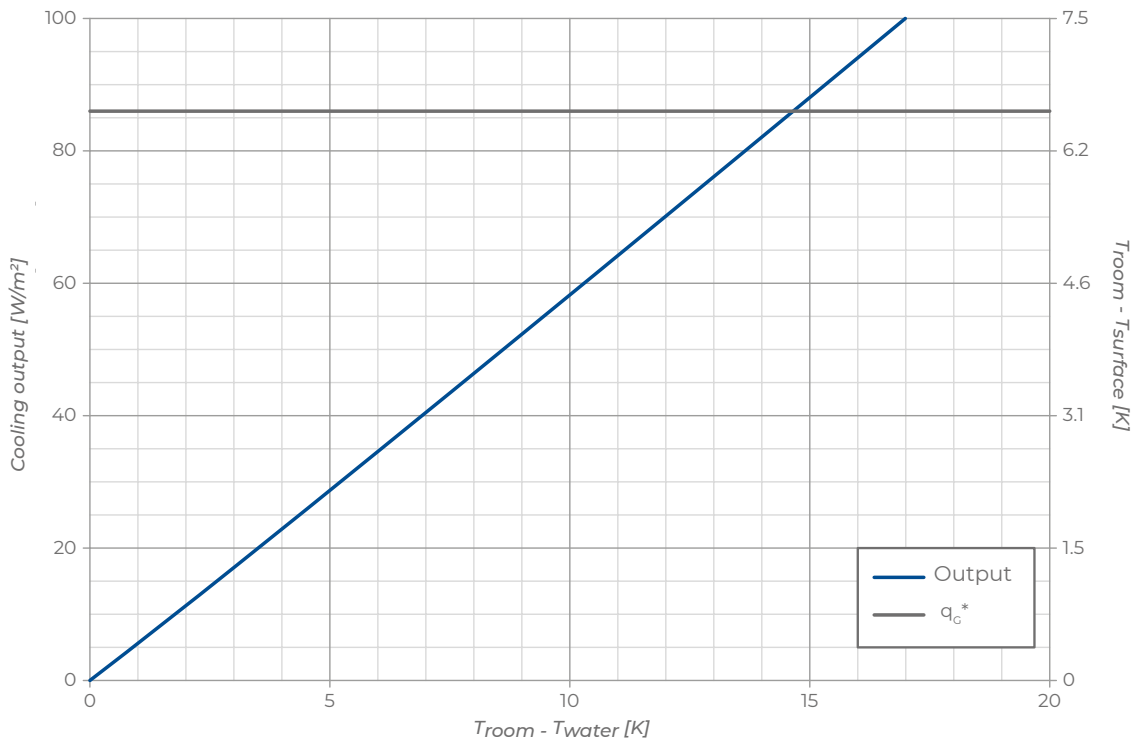

*valid only for room temperature= 26 °C 55% R.H.

Thermal output in cooling - wall

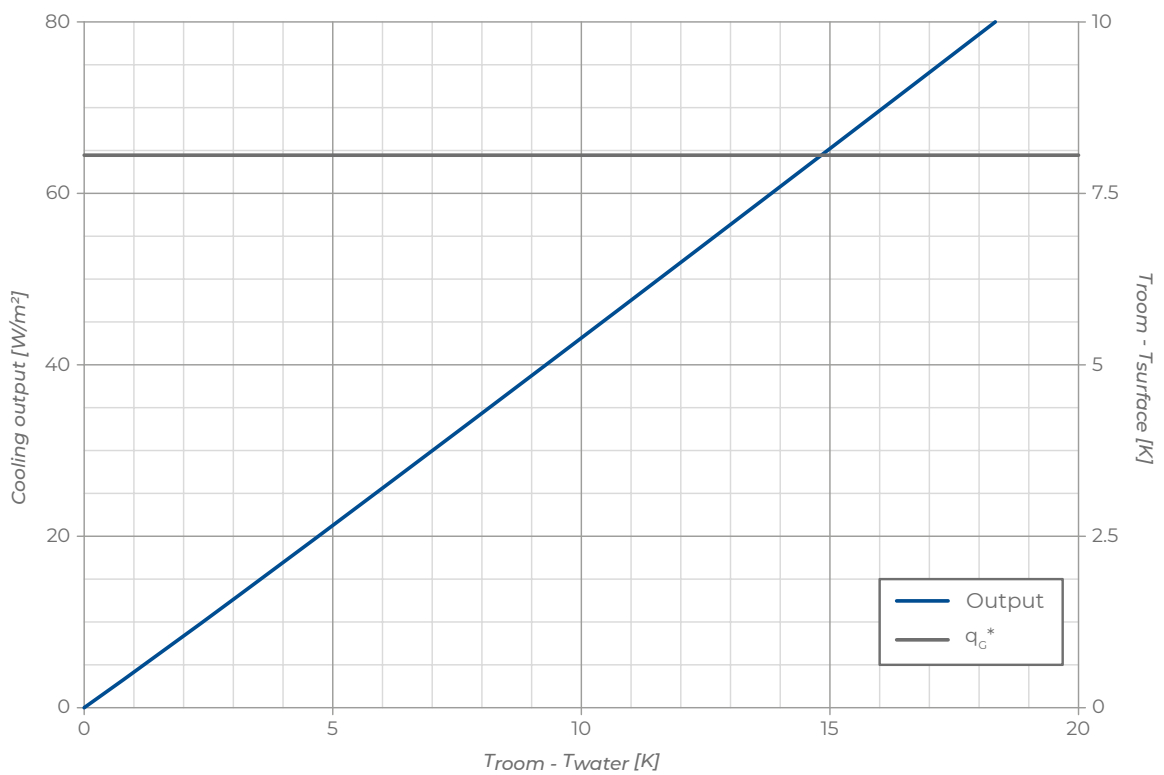

*valid only for room temperature= 26 °C 55% R.H.

B!KLIMAX+ SYSTEM WITH PLASTERBOARD



b!klimax+ with plasterboard is a room heating and cooling system that uses ceilings and walls as radiant surfaces.

Designed to be installed on common metal structures for false ceilings, it does not require invasive interventions and allows to exploit the gap between the ceiling and the radiant panels for the installation of other systems. It is also invisible, comfortable, efficient and guarantees a uniform distribution of temperatures without air movements.

The central element of the system is the panel made up of standard or waterproof plasterboard on which, by an aluminium metal diffuser, 4 hydraulic circuits \varnothing 6 mm are fixed. The panel is available with polystyrene or rockwool insulation. The system is completed by the manifold, the distributors, the fittings, the \varnothing 20 mm pre-insulated polybutylene pipe for connecting the distributors to the manifold and the \varnothing 6 mm pre-insulated polybutylene pipe for connecting the panels to the distributors.

FEATURES

- Minimum recommended installation height 12 cm
- Ceiling or wall installation
- Low thermal inertia
- Available with standard or waterproof plasterboard sheet
- Installation on metal structure with 30 cm wheelbase
- Insulation in polystyrene or rockwool
- Particularly suitable for renovation
- Suitable for residential and commercial applications



SECTION OF THE SYSTEM



- 1 Adjustable hang
- 2 Pre-insulated pipe \varnothing 6mm
- 3 Plasterboard sheet
- 4 Metal structure
- 5 Pre-insulated pipe \varnothing 20 mm
- 6 Passive filling panel
- 7 Distributor with insulation shell
- 8 Painting/grouting

METAL SUPPORT STRUCTURE

b!klimax+ radiant panels are designed to be installed both on walls and ceilings on common double metal frame structures for dry systems available on the market.

Depending on the height of the rooms, it is possible to modulate the height of the pendant hooks according to specific requirements (aesthetic, based on the need to pass the ducts for other systems, etc.).

Hanging structure with snap profile

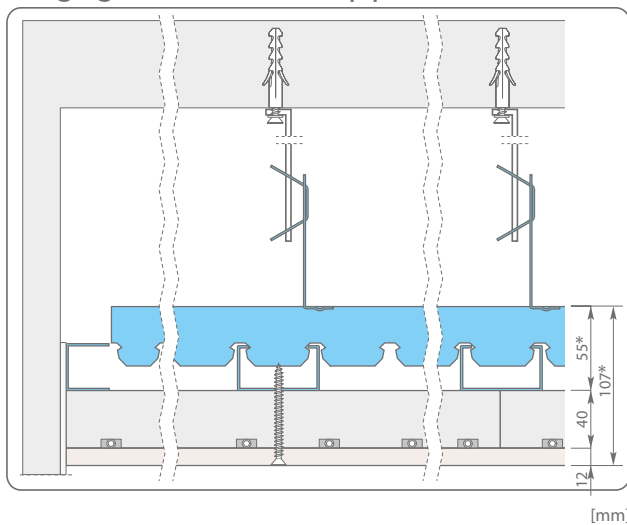

Structure with snap profile

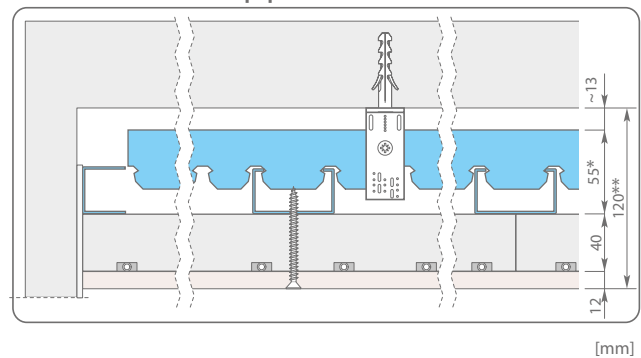

* Variable dimension depending on the profile used.

** If possible, to facilitate installation, we suggest a minimum height of 150 mm.

PRODUCTS THAT COMPOSE THE SYSTEM

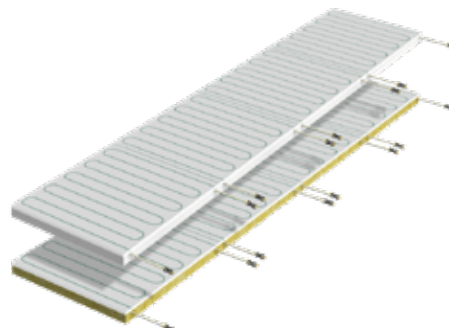
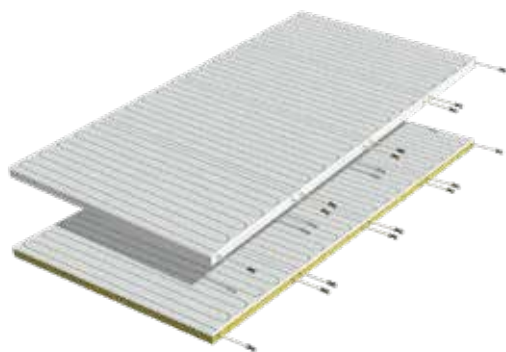

Panel features

Dimensions: 1200x2400x52 mm

INSULATION	WEIGHT	CODE
Polystyrene	29.2 Kg	6142100
Polys. waterproof	29.8 Kg	6143100
Rockwool	47.6 Kg	6142200

Panel features

Dimensions: 600x2400x52 mm

INSULATION	WEIGHT	CODE
Polystyrene	14.6 Kg	6142160
Rockwool	23.8 Kg	6142260

b!klimax+ plasterboard panel

The b!klimax+ plasterboard radiant panel is made up of a standard plasterboard sheet or plasterboard on which the drawings of the hydraulic circuits are printed. On the plasterboard are fixed by means of an aluminium diffuser 4 circuits Ø 6 mm including quick couplings. The panel with standard slab is available with polystyrene or rockwool insulation (fire reaction class: A1); the waterproof panel is only available with polystyrene insulation.

Plasterboard characteristics	600	1200	Unit	Standard
Size	600x2400	1200x2400	mm	
Standard thickness	12.5		mm	
Density	760		Kg / m ³	
Fire reaction	A2-s1,d0			
Thermal conductivity	0.20		W / (m · K)	
Water vapour diffusion resistance factor	10		μ	EN 10456

Polystyrene insulation characteristics		600	1200	Unit	Standard
Size of insulating panel		600x2400	1200x2400	mm	UNI EN 822
Standard thickness		40		mm	UNI EN 823
Insulation base thickness		34		mm	UNI EN 1264-3
Equivalent total thickness		38.6	38.8	mm	UNI EN 1264-3
Bending strength	BS	170		kPa	UNI EN 12089
Compressive stress at 10% deformation	CS(10)	120		kPa	UNI EN 826
Thermal conductivity 10 °C	λd	0.035		W/(m · K)	UNI EN 12667
Thermal resistance	Rd	1.10		(m ² · K)/W	UNI EN 12667
Thermal transmittance	U	0.90		W/(m ² · K)	
Water vapour diffusion resistance factor	μ	30 ÷ 70			UNI EN 12086
Water vapour permeability	δ	0.009 ÷ 0.020		mg/(Pa · h · m)	UNI EN 12086
Dimensional stability at 48h and 70 °C	DS(70,-)	1		%	UNI EN 1604
Long term water absorption by partial immersion	Wlp	0.5		Kg / m ²	UNI EN 12087
Long term water absorption by total immersion	WI(T)	≤3		%	UNI EN 12087
Fire reaction	Euroclass	E			EN ISO 11925-2
Limit of operating temperature		70		°C	
Declaration according to UNI EN 13163		T1-L3-W2-S2-P5-BS170-CS(10)120-DS(70,-)1-WL(T)3-MU(30-70)			

Rockwool insulation characteristics		600	1200	Unit	Standard
Size of insulating panel		600x2400	1200x2400	mm	UNI 822
Standard thickness		40		mm	UNI 823
Declared thermal conductivity	λ_d	0.040		W/(m · K)	UNI EN 12667, 12939
Thermal resistance	R_d	1		(m ² · K)/W	
Resistance to compression 10%	σ_{10}	70		kPa	UNI EN 826
Resistance to point load	F_p	600		N	UNI EN 12430
Tensile bond strength	σ_{mt}	15		kPa	UNI EN 1607
Water vapour diffusion resistance factor	μ	1			UNI EN 12086
Short term water absorption by partial immersion	W_s	< 1		kg/m ²	EN 1609
Long term water absorption by immersion	$W_l(p)$	< 3		kg/m ²	EN 12087
Specific heat	C_p	1030		J / (KgK)	UNI EN 10456
Density	ρ	165		Kg/m ³	UNI EN 1602
Fire reaction	Euroclass	A1			UNI EN 13501-1
Declaration according to UNI EN 13162		MW-EN 13162 T5-CS(10/Y)70-PL(5)600-TR15-DS(TH)-DS(T+)-MU1-WS-WL(p)			

PE-HD-Xc pipe characteristics								
Outside diam. (mm)	Thickness (mm)	S-value	SDR-value	CLASS 4		CLASS 5		Water content (l/m)
6	1	2.5	6	Tmax 60 °C	10 bar	Tmax 80 °C	10 bar	0,013

S = nominal pipe serial number according to ISO 4065, SDR = standard dimension ratio, allocation of SDR values, according to DIN 16893 and/or DIN EN ISO15875-2

Technical data of PE-HD-Xc pipe		Value	Unit	Standard
Degree of cross-linking	23°C	≥ 60	%	DIN 16892
Density	23°C	≈ 0.94	g/cm ³	DIN 16892/DIN 53479
Flexural impact strength accord. to Charpy	23°C	no failure	kJ/m ²	DIN EN ISO 179-1/2
Tensile strength	23°C	24 ÷ 30	N/mm ²	DIN EN ISO 6259-1
Tenacity	23°C	24 ÷ 26	N/mm ²	DIN EN ISO 6259-1
Elongation at break	23°C	400 ÷ 600	%	DIN EN ISO 6259-1
Elastic modulus	23°C	600 ÷ 800	N/mm ²	DIN 16892/DIN EN ISO 128
Stress crack resistance		no failure		ASTM D 1693
Moisture absorption		< 0,01	mg (4d)	DIN EN ISO 62
Coefficient of linear expansion	0°C – 70°C	1,5 · 10 ⁻⁴	1/K	DIN 16892 / DIN 53752
Thermal conductivity		≤ 0,41	W/(K · m)	DIN 16892 / DIN EN 12664
Smallest bend radius		≥ 5 · D	mm	DIN 4726
Oxygen tightness	40°C	≤ 0,32	mg/(m ² · d)	DIN 4726

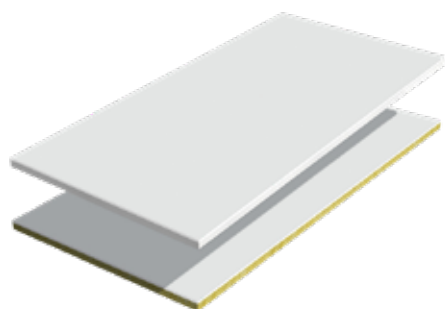

Blank panel

Passive panel consisting of standard or waterproof plasterboard sheet, without hydraulic circuits and available with polystyrene or rockwool (fire reaction class: A1) insulation. Waterproof panel is only available with polystyrene insulation. Necessary for filling areas not covered by radiant panels and areas where distributors are located.

Panel features

Dimensions: 1200x2400x52 mm

INSULATION	WEIGHT	CODE
Polystyrene	27.8 Kg	6142105
Polys. waterproof	28.5 Kg	6143105
Rockwool	46.9 Kg	6142205



Pre-insulated pipe Ø 20 mm

PB pipe with oxygen barrier according to DIN 4726 EN 12319-2, Ø 20 mm, pipe insulation made of expanded polyethylene, thickness 6 mm. Reaction to fire class: BL-s2, d0. It is used to connect distributors with b!klimax manifolds.

TYPE	SIZE	CODE
red roll 50 m	Ø 20 mm	6200020
blu roll 50 m	Ø 20 mm	6201020
red 1 bar 4 m	Ø 20 mm	6202020
blu 1 bar 4 m	Ø 20 mm	6203020

Note:
for further technical data see page 74



8-way Distributors

Pair of distributors made of plastic, specially shaped to guarantee easy connection with the pipes coming from b!klimax panels. These distributors are provided with anticondensation shells made of polystyrene or expanded polyethylene BL-s1, d0, push-fit pipe fittings for pipes Ø 6 mm and Ø 20 mm, and closing plastic bands.

MODEL	INSULATION	CODE
8-way open	polystyrene	6210040
8-way open	polyethylene	6210041
8-way terminal	polystyrene	6210050
8-way terminal	polyethylene	6210051



4-way Distributors

Pair of distributors made of plastic, specially shaped to guarantee easy connection with the pipes coming from b!klimax panels. These distributors are provided with anticondensation shells made of polystyrene or expanded polyethylene BL-s1, d0, push-fit pipe fittings for pipes Ø 6 mm and Ø 20 mm, and closing plastic bands.

MODEL	INSULATION	CODE
4-way open	polystyrene	6210060
4-way open	polyethylene	6210061
4-way terminal	polystyrene	6210070
4-way terminal	polyethylene	6210071



Straight Push-fit Fitting Ø 6 mm

Straight push-fit fitting used as connection for polybutylene pipes Ø 6 mm. It's provided with anticondensation insulation shells available in polystyrene or polyethylene BL-s1, d0.

SIZE	INSULATION	CODE
Ø 6 mm	polystyrene	6510006
Ø 6 mm	polyethylene	6510016
Ø 20 mm	polyethylene	6510026



TEE Push-fit Fitting 20-20-20 mm

TEE push-fit fitting used as connection for PB pipes Ø 20 mm. It's provided with anticondensation insulation shells available in polystyrene or polyethylene BL-s1, d0.

SIZE	INSULATION	CODE
Ø 20 mm	polystyrene	6510055
Ø 20 mm	polyethylene	6510056



Cross Push-fit Fitting 20-20-20-20 mm

This cross push-fit fitting is used as connection for polybutylene pipes Ø 20 mm. It's provided with anticondensation insulation shells available in polystyrene or polyethylene BL-s1, d0.

SIZE	INSULATION	CODE
Ø 20 mm	polystyrene	6510065
Ø 20 mm	polyethylene	6510066



Elbow Push-fit Fitting 20-20 mm

This ELBOW push-fit fitting is used as 90° shifting for polybutylene pipes Ø 20 mm. It's provided with polyethylene BL-s1, d0 insulation or without it.

SIZE	INSULATION	CODE
Ø 20 mm	- -	6510075
Ø 20 mm	polyethylene	6510076

PRODUCTS THAT COMPOSE THE SYSTEM



Pre-insulated PB Pipe Ø 6 mm

PB pipe Ø 6 mm with oxygen barrier according to DIN 4726 EN 12319-2, pipe insulation made of expanded polyethylene, reaction to fire class BL-s1,d0, thickness 6 mm. It is used to connect b!klimax+ and Quadroto panels to the distributors.

SIZE	CODE
Ø 6 mm	6210006

Note:
for further technical data see page 73



Lubricant for Push-fit Pipe Fittings

This lubricant is used to guarantee better insertion of the pipes into the fittings and better preservation of O-rings. (1 package every 75 circuits).

SIZE	CODE
20 ml	6603000



Closing Plugs for Outlets Ø 6 mm and Ø 20 mm

Plastic plugs are used to close the unused outlets in a distributor.

SIZE	CODE
Ø 6 mm	6510040
Ø 20 mm	6510050



Industry System Elbow

Elbow for 90° shifting with pipes Ø 20 mm.

SIZE	CODE
Ø 20 mm	1140025



70-mm Fixing Screws

70-mm screws to fix b!klimax+ panels with plasterboard to the metal grid.

SIZE	CODE
70 mm	6510010



b!klimax Perimeter belt

Edge insulation for b!klimax and b!klimax+ ceiling systems, made of closed-cell expanded polyethylene. It acts as thermo-acoustic insulation and it absorbs plasterboard ceiling expansions.

SIZE	CODE
h 150 mm	6603010



Spare parts kit

Replacement kit for b!klimax fittings and distributors including all the components needed to restore a pipe connection.

SIZE	CODE
for Ø 6 mm pipe	6510070
for Ø 20 mm pipe	6510080

THERMAL OUTPUT OF THE SYSTEM

Thermal output in heating - ceiling

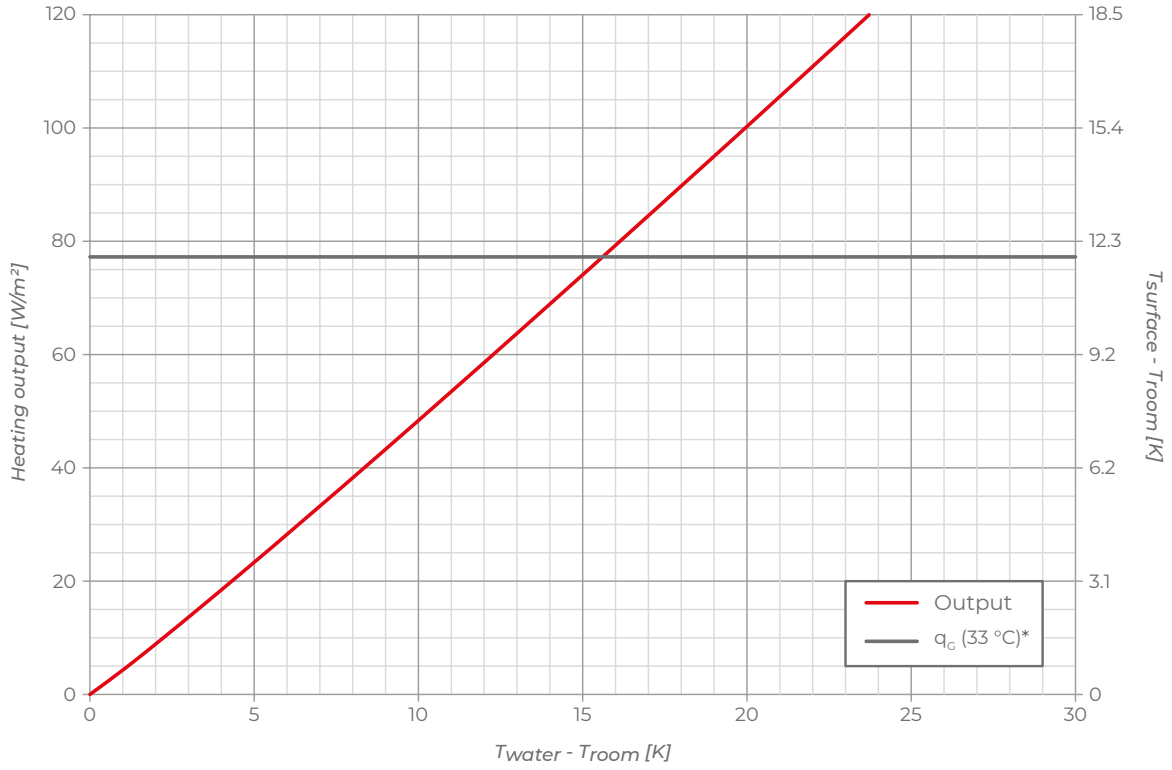

*valid only for room temperature= 20 °C

Thermal output in heating - wall

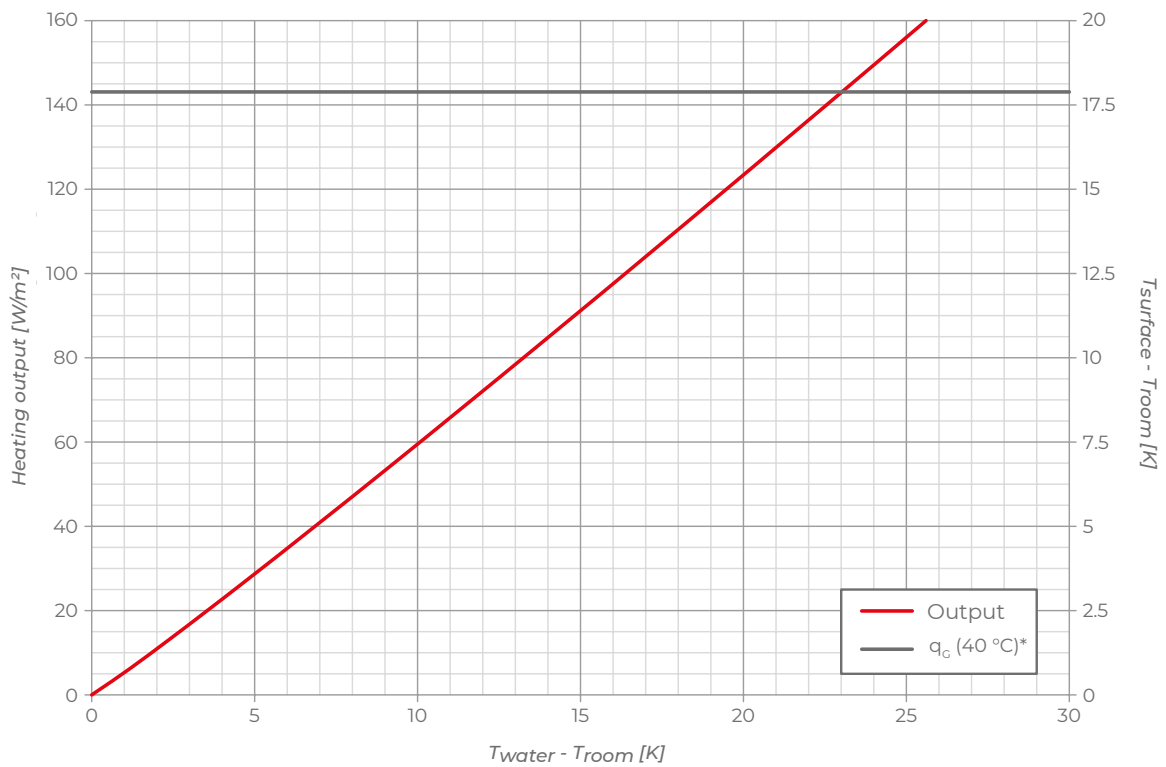

*valid only for room temperature= 20 °C

Thermal output in cooling - ceiling

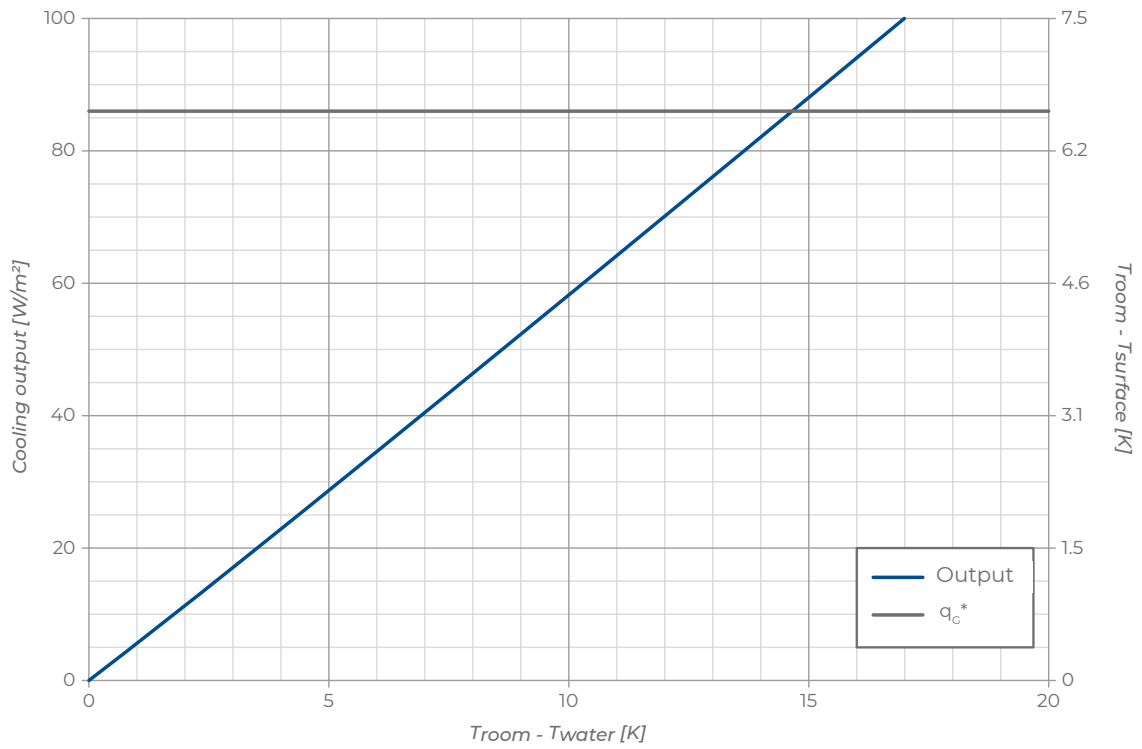

*valid only for room temperature= 26 °C 55% R.H.

Thermal output in cooling - wall

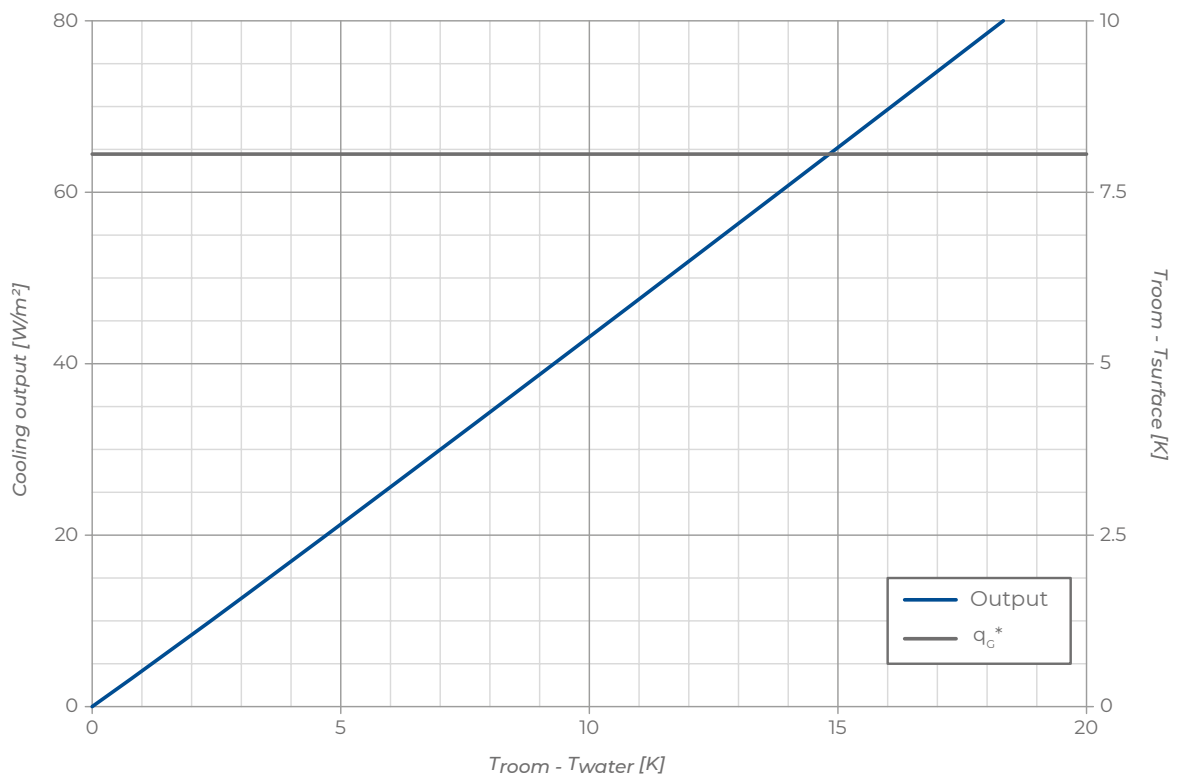

*valid only for room temperature= 26 °C 55% R.H.

B!KLIMAX 8+ SYSTEM WITH PLASTERBOARD



b!klimax 8+ is a room heating and cooling system that uses ceilings and walls as radiant surfaces. Invisible and efficient, it guarantees uniform temperature distribution and high thermal comfort in every room. The use of \varnothing 8 mm pipe also means that there are fewer circuits and therefore fewer components, speeding up installation operations.

Designed to be installed on common metal structures for false ceilings, it does not require invasive interventions and allows to exploit the gap between the ceiling and the radiant panels for the installation of other systems.

The central element of the system is the panel consisting of a plasterboard sheet onto which, by an aluminium metal diffuser, 2 hydraulic circuits in PE-RT \varnothing 8 mm pipe are fixed. The panel is available with polystyrene or rockwool insulation.

The system is completed by the manifold, the distributors, the fittings, the \varnothing 20 mm polybutylene pre-insulated pipe for connecting the distributors to the manifold and the \varnothing 8 mm PE-RT pipe with insulation for connecting the panels to the distributors.

FEATURES

- Minimum recommended installation height 12 cm
- Ceiling or wall installation
- Low thermal inertia
- Installation on metal structure with 30 cm spacing
- Insulation in polystyrene or rockwool
- Particularly suitable for renovation
- Suitable for residential and commercial applications
- Quick installation thanks to the reduced number of components



SECTION OF THE SYSTEM



- 1 Hanging metal structure
- 2 Distributor with insulation shell
- 3 Pre-insulated pipe Ø 20 mm
- 4 Pre-insulated pipe Ø 8 mm
- 5 b!klimax 8+ panel
- 6 Passive filling panel
- 7 Painting/grouting

METAL SUPPORT STRUCTURE

b!klimax 8+ radiant panels are designed to be installed both on walls and ceilings on common double metal frame structures for dry systems available on the market.

Depending on the height of the rooms, it is possible to modulate the height of the pendant hooks according to specific requirements (aesthetic, based on the need to pass the ducts for other systems, etc.).

Hanging structure with snap profile

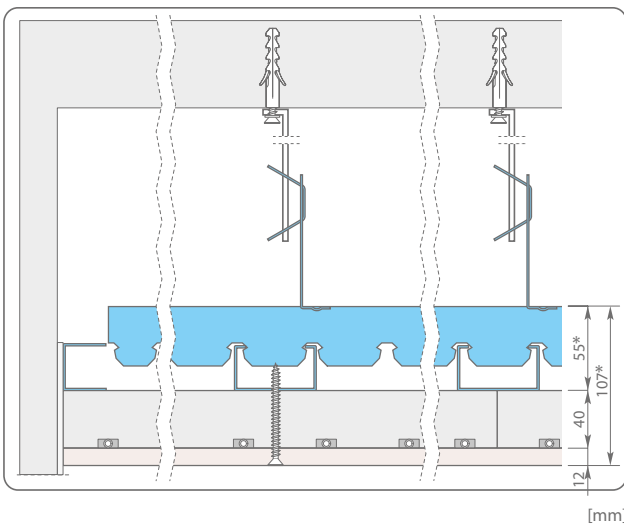

Structure with snap profile

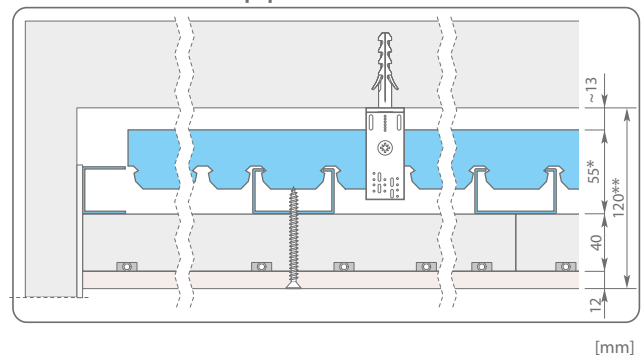

* Variable dimension depending on the profile used.

** If possible, to facilitate installation, we suggest a minimum height of 150 mm.

PRODUCTS THAT COMPOSE THE SYSTEM

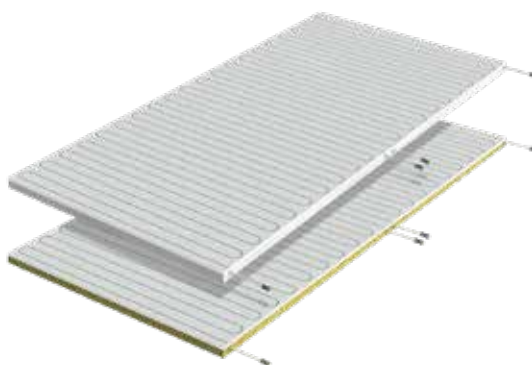

Panel features
Dimensions: 1200x2400x52 mm

INSULATION	WEIGHT	CODE
Polystyrene	29.5 Kg	6142115
Rockwool	47.9 Kg	6142210



Panel features
Dimensions: 600x2400x52 mm

INSULATION	WEIGHT	CODE
Polystyrene	14.9 Kg	6142170
Rockwool	24.1 Kg	6142270

b!klimax 8+ panel with plasterboard

b!klimax 8+ radiant panels are made up of 12.5-mm thick plasterboard of 2.88 m². On the plasterboard is printed the position of the hydraulic circuits, made of PE-RT pipe Ø 8 mm and embedded in the panel, provided with push-fit fittings and oxygen barrier according to DIN 4726. Pipes are fixed to the panel through an aluminium metal diffuser. Available with different insulation types.

Plasterboard characteristics	600	1200	Unit	Standard
Size	600x2400	1200x2400	mm	
Standard thickness	12.5		mm	
Density	760		Kg / m ³	
Fire reaction	A2-s1,d0			
Thermal conductivity	0.20		W / (m · K)	
Water vapour diffusion resistance factor	10		μ	EN 10456

Polystyrene insulation characteristics	600	1200	Unit	Standard
Size of insulating panel	600x2400	1200x2400	mm	UNI EN 822
Standard thickness	40		mm	UNI EN 823
Insulation base thickness	34		mm	UNI EN 1264-3
Equivalent total thickness	38.6	38.8	mm	UNI EN 1264-3
Bending strength	BS	170	kPa	UNI EN 12089
Compressive stress at 10% deformation	CS(10)	120	kPa	UNI EN 826
Thermal conductivity 10 °C	λd	0.035	W/(m · K)	UNI EN 12667
Thermal resistance	Rd	1.10	(m ² · K)/W	UNI EN 12667
Thermal transmittance	U	0.90	W/(m ² · K)	
Water vapour diffusion resistance factor	μ	30 ÷ 70		UNI EN 12086
Water vapour permeability	δ	0.009 ÷ 0.020	mg/(Pa · h · m)	UNI EN 12086
Dimensional stability at 48h and 70 °C	DS(70,-)	1	%	UNI EN 1604
Long term water absorption by partial immersion	Wlp	0.5	Kg / m ²	UNI EN 12087
Long term water absorption by total immersion	WI(T)	≤3	%	UNI EN 12087
Fire reaction	Euroclass	E		EN ISO 11925-2
Limit of operating temperature		70	°C	
Declaration according to UNI EN 13163	T1-L3-W2-S2-P5-BS170-CS(10)120-DS(70,-)1-WL(T)3-MU(30-70)			

Rockwool insulation characteristics		600	1200	Unit	Standard
Size of insulating panel		600x2400	1200x2400	mm	UNI 822
Standard thickness:		40		mm	UNI 823
Declared thermal conductivity	λ_d	0.040		W/(m · K)	UNI EN 12667, 12939
Thermal resistance	R _d	1		(m ² · K)/W	
Resistance to compression 10%	σ_{10}	70		kPa	UNI EN 826
Resistance to point load	F _p	600		N	UNI EN 12430
Tensile bond strength	σ_{mt}	15		kPa	UNI EN 1607
Water vapour diffusion resistance factor	μ	1			UNI EN 12086
Short term water absorption by partial immersion	W _s	< 1		kg/m ²	EN 1609
Long term water absorption by immersion	W _{l(p)}	< 3		kg/m ²	EN 12087
Specific heat	C _p	1030		J / (KgK)	UNI EN 10456
Density	ρ	165		Kg / m ³	UNI EN 1602
Fire reaction	Euroclas.	A1			UNI EN 13501-1
Declaration according to UNI EN 13162		MW-EN 13162 T5-CS(10/Y)70-PL(5)600-TR15-DS(TH)-DS(T+)-MU1-WS-WL(p)			

PE-RT pipe characteristics					
Application field		CLASS 4	For use with hot and cold water	T _{max} 70 °C	Pressure 8 bar
		CLASS 5	For use with hot and cold water	T _{max} 90 °C	Pressure 6 bar
Outside diam. (mm)	Thickness (mm)	Circuit Length (mm)		Weight (g/m)	Water content (l/m)
8	1	600	1200	22	0,028
		12	24		

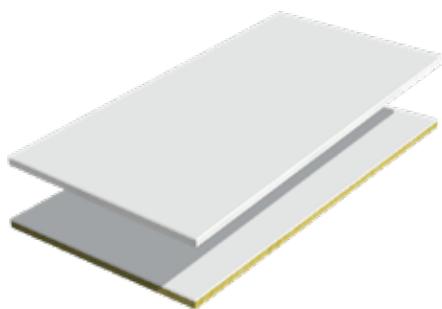

Blank panel

Passive panel consisting of standard or waterproof plasterboard, without hydraulic circuits and available with polystyrene or rockwool (fire reaction class: A1) insulation. Necessary for filling areas not covered by radiant panels and areas where distributors are housed.

Panel features 1200x2400x52 mm

INSULATION	WEIGHT	CODE
Polystyrene	27.8 Kg	6142105
Rockwool	46.9 Kg	6142205



Pre-insulated pipe Ø 20 mm

PB pipe with oxygen barrier according to DIN 4726 EN 12319-2, Ø 20 mm, pipe insulation made of expanded polyethylene, thickness 6 mm. Reaction to fire class: BL-s2, d0. It is used to connect distributors with b!klimax manifolds.

TYPE	SIZE	CODE
red roll 50 m	Ø 20 mm	6200020
blu roll 50 m	Ø 20 mm	6201020
red 1 bar 4 m	Ø 20 mm	6202020
blu 1 bar 4 m	Ø 20 mm	6203020

Note:
for further technical data see page 72



2-way Distributors Ø 8 mm

Pair of distributors made of plastic, specially shaped to guarantee easy connection with the pipes coming from Copper 8 and Quadrotto HP tiles. These distributors are provided with anti-condensation shells made of polystyrene or expanded polyethylene BL-s1, d0, push-fit pipe fittings for pipes Ø 8 mm and Ø 20 mm, and closing plastic bands.

MODEL	INSULATION	CODE
2-way open	polystyrene	6210080
2-way open	polyethylene	6210082



4-way Distributors Ø 8 mm

Pair of distributors made of plastic, specially shaped to guarantee easy connection with the pipes coming from Copper 8 and Quadrotto HP tiles. These distributors are provided with anti-condensation shells made of polystyrene or expanded polyethylene BL-s1, d0, push-fit pipe fittings for pipes Ø 8 mm and Ø 20 mm, and closing plastic bands.

MODEL	INSULATION	CODE
4-way open	polystyrene	6210081
4-way open	polyethylene	6210083



Straight Push-fit Fitting

Straight push-fit fitting used as connection for polybutylene pipes Ø 8 mm. Transparent version. Condensation shells made of polyethylene BL-s1, d0.

SIZE	INSULATION	CODE
Ø 8 mm	polyethylene	6510018
Ø 20 mm	polyethylene	6510026



TEE Push-fit Fitting 20-20-20 mm

TEE push-fit fitting used as connection for PB pipes Ø 20 mm. It's provided with anticondensation insulation shells available in polystyrene or polyethylene BL-s1, d0.

SIZE	INSULATION	CODE
Ø 20 mm	polystyrene	6510055
Ø 20 mm	polyethylene	6510056



Cross Push-fit Fitting 20-20-20-20 mm

This cross push-fit fitting is used as connection for polybutylene pipes Ø 20 mm. It's provided with anticondensation insulation shells available in polystyrene or polyethylene BL-s1, d0.

SIZE	INSULATION	CODE
Ø 20 mm	polystyrene	6510065
Ø 20 mm	polyethylene	6510066



Elbow Push-fit Fitting 20-20 mm

This ELBOW push-fit fitting is used as 90° shifting for polybutylene pipes Ø 20 mm. It's provided with polyethylene BL-s1, d0 insulation or without it.

SIZE	INSULATION	CODE
Ø 20 mm	- -	6510075
Ø 20 mm	polyethylene	6510076

PRODUCTS THAT COMPOSE THE SYSTEM



PE-RT pipe Ø 8 mm

PE-RT pipe Ø 8 mm with oxygen barrier according to DIN 4726 DIN EN ISO 21003-2, thickness 1 mm. It is used to connect b!klimax+ Copper 8 and Quadrotto HP tiles with the distributors.

SIZE	CODE
Ø 8 mm	6210018

Note:
for further technical data see page 74



Insulation for PE-RT pipe Ø 8 mm

Insulation for PE-RT pipe Ø 8 mm made of expanded polyethylene, thickness 6 mm. Reaction to fire class: BL -s1, d0.

SIZE	CODE
Ø 8 mm	6320008



Lubricant for Push-fit Pipe Fittings

This lubricant is used to guarantee better insertion of the pipes into the fittings and better preservation of O-rings. (1 package every 75 circuits).

SIZE	CODE
20 ml	6603000



Closing Plugs for Outlets Ø 8 mm and Ø 20 mm

Plastic plugs are used to close the unused outlets in a distributor.

SIZE	CODE
Ø 8 mm	6510041
Ø 20 mm	6510050



Industry System elbow

Elbow for 90° shifting with pipes Ø 20 mm.

SIZE	CODE
Ø 20 mm	1140025



70-mm Fixing Screws

70-mm screws to fix b!klimax+ panels with plasterboard to the metal grid.

SIZE	CODE
70 mm	6510010



b!klimax Perimeter belt

Edge insulation for b!klimax and b!klimax+ ceiling systems, made of closed-cell expanded polyethylene. It acts as thermo-acoustic insulation and it absorbs plasterboard ceiling expansions.

SIZE	CODE
h 150 mm	6603010



Spare parts kit

Replacement kit for b!klimax fittings and distributors including all the components needed to restore a pipe connection.

SIZE	CODE
for Ø 8 mm pipe	6510071
for Ø 20 mm pipe	6510080

THERMAL OUTPUT OF THE SYSTEM

Thermal output in heating - ceiling

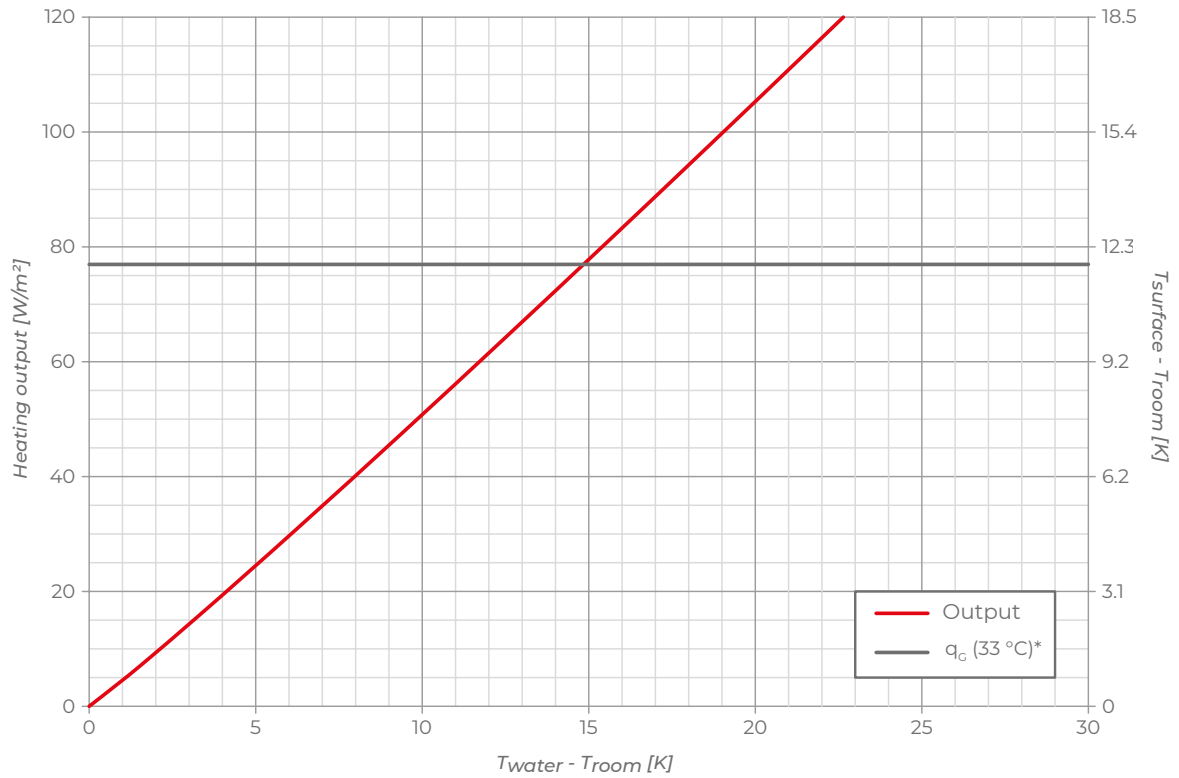

*valid only for room temperature= 20 °C

Thermal output in heating - wall

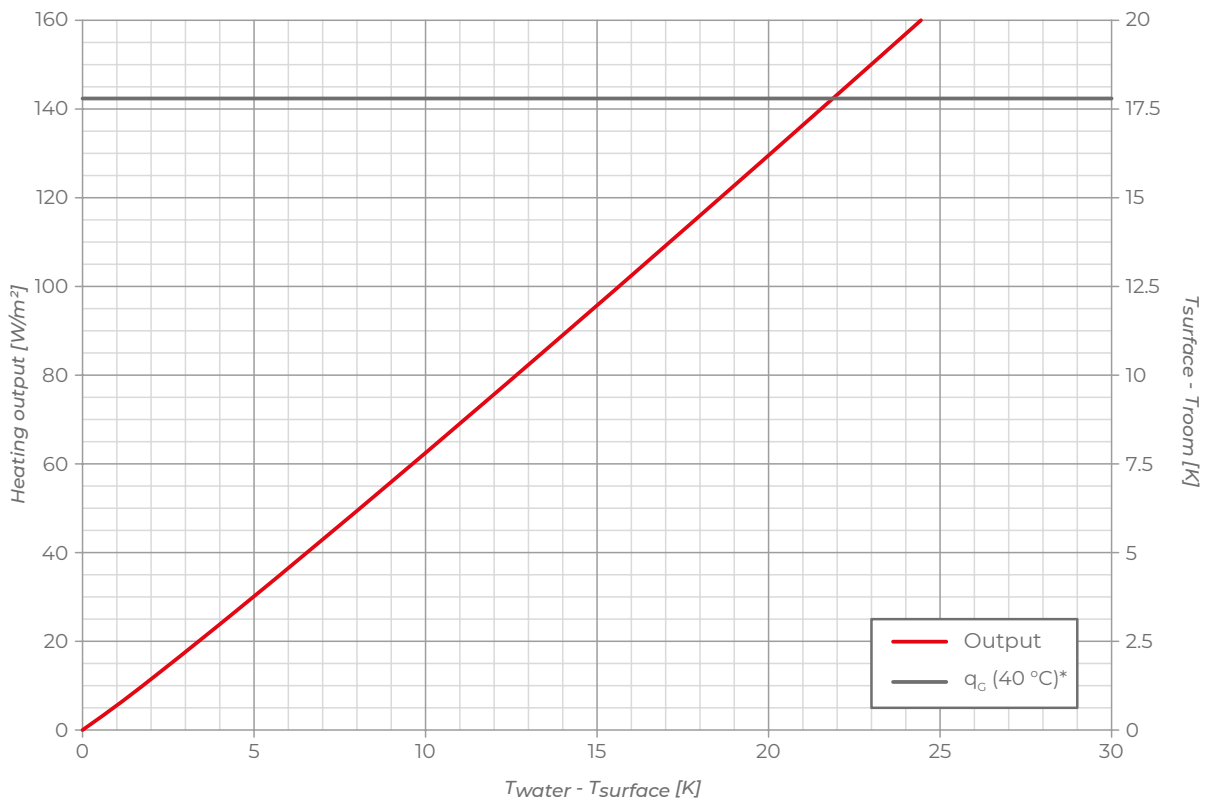

*valid only for room temperature= 20 °C

Thermal output in cooling - ceiling

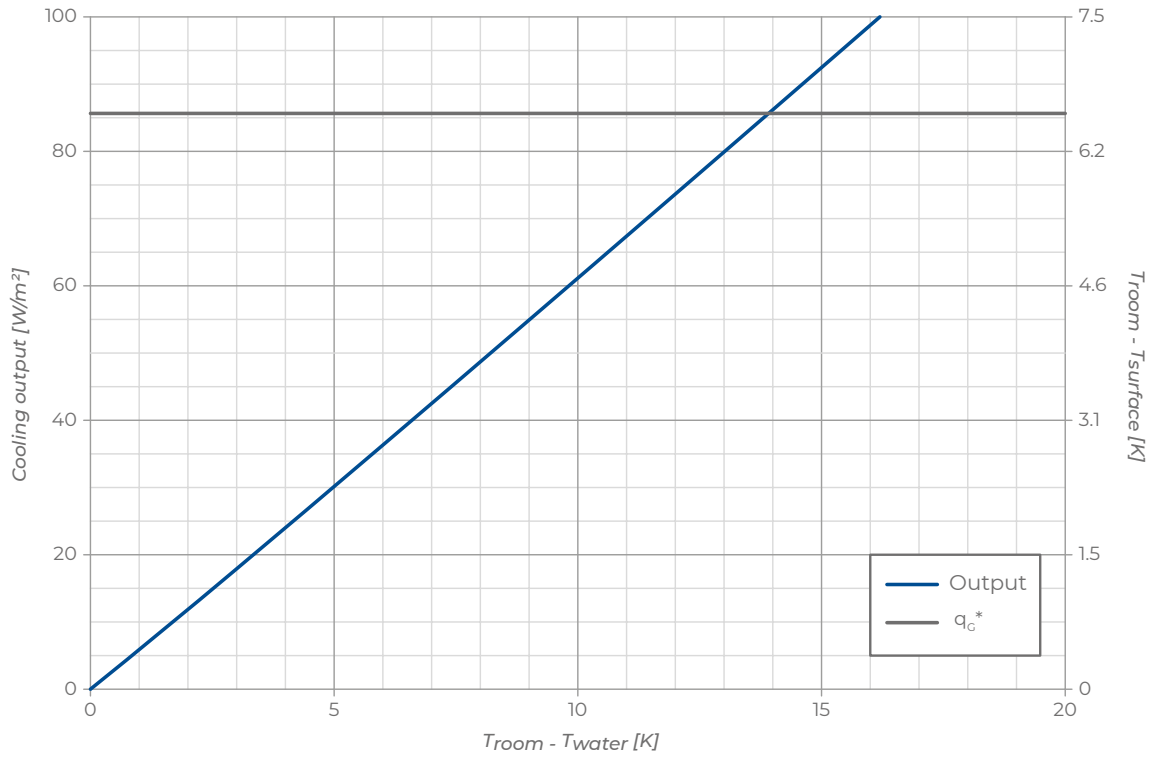

*valid only for room temperature= 26 °C 55% R.H.

Thermal output in cooling - wall

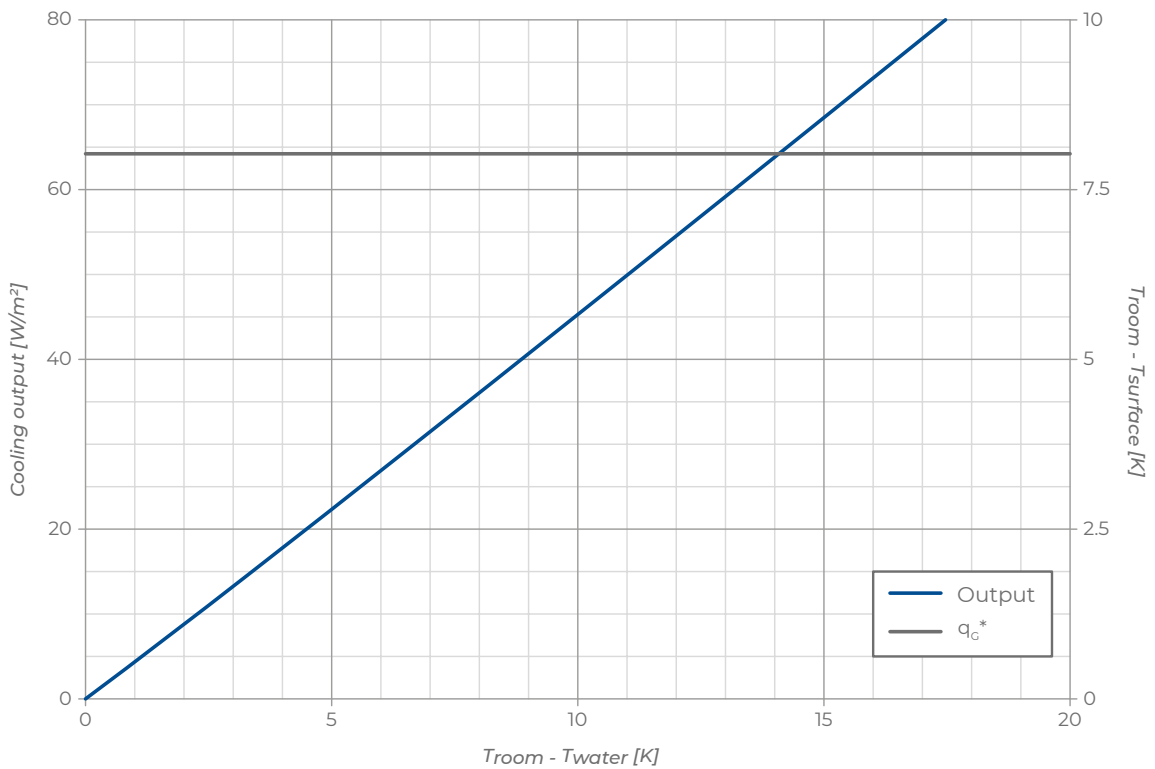

*valid only for room temperature= 26 °C 55% R.H.



Traditional b!klimax is a ceiling and wall heating and cooling system characterised by high performance and the absence of thermal bridges, able to guarantee uniform temperature distribution, no air jets and great freedom of finishing.

The main components of the system are the 600 and 1200 polystyrene radiant panels shaped to place the \varnothing 6 mm pipe and covered with a layer of fibre-reinforced gypsum. This allows the system to be coated with any type of finish (plasterboard, plaster, matchboard, etc.).

The system is completed by the manifold, the distributors, the fittings, the \varnothing 20 mm polybutylene pre-insulated pipe for the connection of the distributors to the manifold, the \varnothing 6 mm polybutylene pipe for the connection of the panels to the distributors, the lubricant for push-fit fittings which facilitates the insertion of the pipe and favours the preservation of the o-rings and the retarder additive for the coupling of the plasterboard sheets to the radiant panels.

As the traditional b!klimax system is installed on a suspended metal structure, the gap between the radiant surface and the radiant panels can be used for other systems.

FEATURES

- Minimum recommended installation height 12 cm
- Ceiling or wall installation
- Low thermal inertia
- Polystyrene insulation
- Possibility of finishing with any non-insulating material
- Lightweight and easy to handle panels
- Particularly suitable for renovation
- Suitable for residential and commercial applications



SECTION OF THE SYSTEM

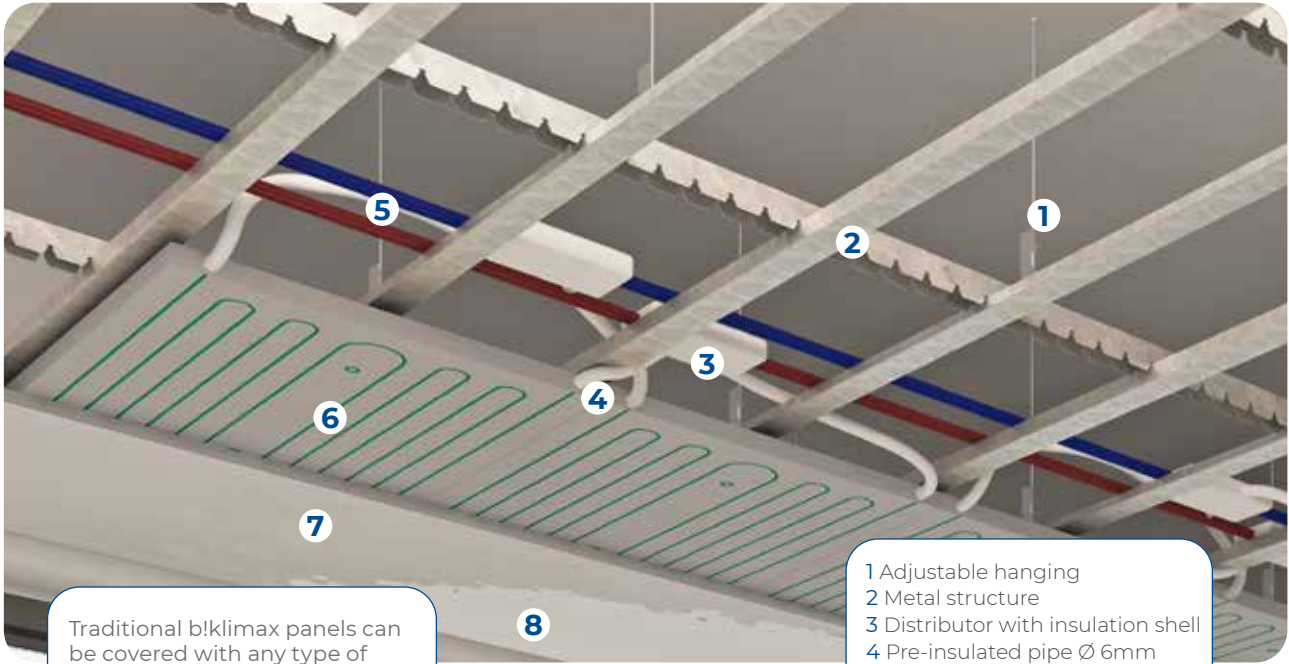

Traditional b!klimax panels can be covered with any type of plasterboard or finished directly with a reinforced skim coat.

- 1 Adjustable hanging
- 2 Metal structure
- 3 Distributor with insulation shell
- 4 Pre-insulated pipe Ø 6mm
- 5 Pipe Ø 20 mm
- 6 Radiant panels
- 7 Plasterboard sheet
- 8 Finish

METAL SUPPORT STRUCTURE

The traditional b!klimax radiant panels are designed to be installed both on walls and ceilings on common double metal frame structures for dry systems available on the market. Depending on the height of the rooms, it is possible to modulate the height of the pendant hooks according to specific requirements (aesthetic, based on the need to pass the ducts for other systems, etc.).

Hanging structure with snap profile

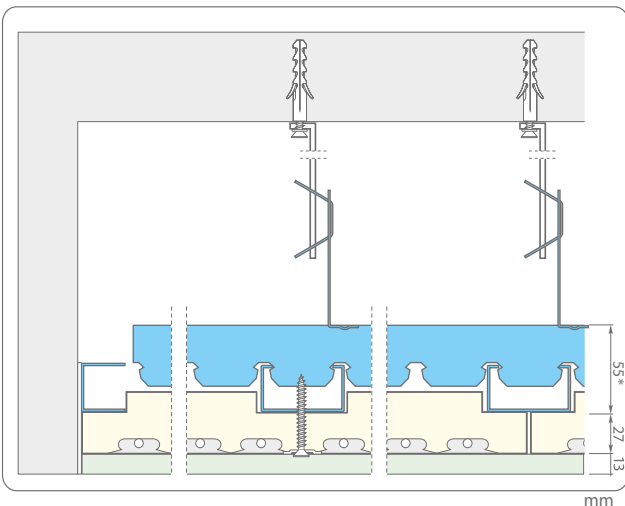

Structure with snap profile

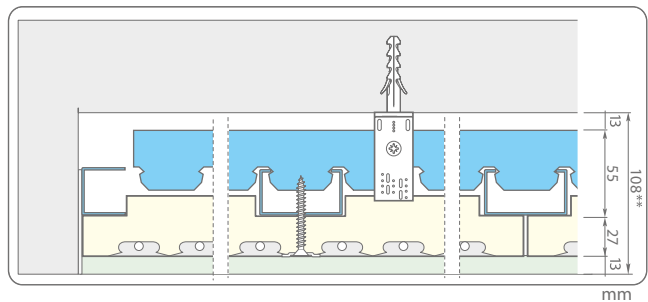

* Variable dimension depending on the profile used.

** If possible, to facilitate installation, we suggest a minimum height of 140 mm.

■ PRODUCTS THAT COMPOSE THE SYSTEM

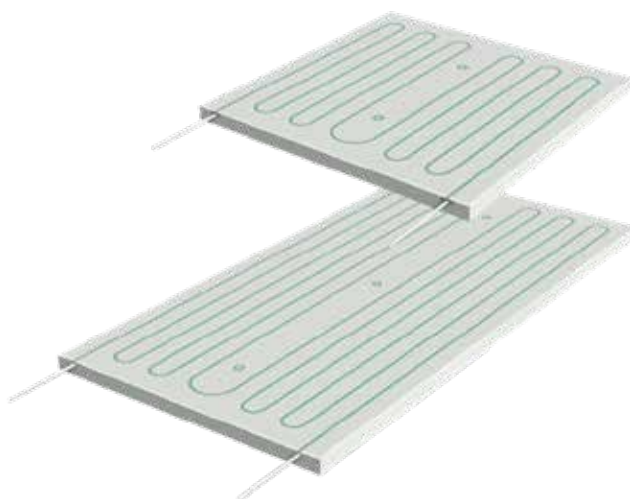

Panel features

SIZE	WEIGHT	CODE
600x600x40 mm	3.1 Kg	6100595
1200x600x40 mm	6.7 Kg	6101200

Traditional b!klimax radiant panel

b!klimax radiant panel is made of polystyrene, thickness 40 mm, and it includes pipes \varnothing 6 mm with oxygen barrier according to DIN 4726. Panel and pipes are covered with a special layer of reinforced pre-plaster to increase their thermal output.

Polystyrene insulation characteristics		600	1200	Unit	Standard
Size of insulating panel		596x596	1202x596	mm	UNI EN 822
Standard thickness		39		mm	UNI EN 823
Insulation base thickness		30		mm	UNI EN 1264-3
Equivalent total thickness		32.7	33.4	mm	UNI EN 1264-3
Bending strength	BS	200		kPa	UNI EN 12089
Resistenza a compressione con deformazione 10 %	CS(10)	150		kPa	UNI EN 826
Thermal conductivity 10 °C	λ_d	0.034		W/(m · K)	UNI EN 12667
Thermal resistance	Rd	0.95		(m ² · K)/W	UNI EN 12667
Thermal transmittance	U	1.05		W/(m ² · K)	
Water vapour diffusion resistance factor	μ	30 ÷ 70			UNI EN 12086
Water vapour permeability	δ	0.009 ÷ 0.020		mg/(Pa · h · m)	UNI EN 12086
Dimensional stability at 48h and 70 °C	DS(70,-)	1		%	UNI EN 1604
Long term water absorption by partial immersion	WIp	0.5		Kg/m ²	UNI EN 12087
Long term water absorption by total immersion	WI(T)	≤3		%	UNI EN 12087
Fire reaction	Euroclass	E			EN ISO 11925-2
Limit of operating temperature		70		°C	
Declaration according to UNI EN 13163	T1-L3-W2-S2-P5-BS200-CS(10)150-DS(70,-)1-WL(T)3-MU(30-70)				

PE-HD-Xc pipe characteristics								
Outside diam. (mm)	Thickness (mm)	S-value	SDR-value	CLASS 4		CLASS 5		Water content (l/m)
6	1	2.5	6	Tmax 60 °C	10 bar	Tmax 80 °C	10 bar	0,013
S = nominal pipe serial number according to ISO 4065, SDR = standard dimension ratio, allocation of SDR values, according to DIN 16893 and/or DIN EN ISO15875-2								
Technical data of PE-HD-Xc pipe			Value	Unit	Standard			
Degree of cross-linking			23°C	≥ 60	%	DIN 16892		
Density			23°C	≈ 0.94	g/cm ³	DIN 16892/DIN 53479		
Flexural impact strength accord. to Charpy			23°C	no failure	kJ/m ²	DIN EN ISO 179-1/2		
Tensile strength			23°C	24 ÷ 30	N/mm ²	DIN EN ISO 6259-1		
Tenacity			23°C	24 ÷ 26	N/mm ²	DIN EN ISO 6259-1		
Elongation at break			23°C	400 ÷ 600	%	DIN EN ISO 6259-1		
Elastic modulus			23°C	600 ÷ 800	N/mm ²	DIN 16892/DIN EN ISO 128		
Stress crack resistance				no failure		ASTM D 1693		
Moisture absorption				< 0,01	mg (4d)	DIN EN ISO 62		
Coefficient of linear expansion			0°C – 70°C	1,5 · 10 ⁻⁴	1/K	DIN 16892 / DIN 53752		
Thermal conductivity				≤ 0,41	W/(K · m)	DIN 16892 / DIN EN 12664		
Smallest bend radius				≥ 5 · D	mm	DIN 4726		
Oxygen tightness			40°C	≤ 0,32	mg/(m ² · d)	DIN 4726		



Blank panel

This neutral panel is made of polystyrene, thickness 27 mm, and it is used to finish the areas not fitted with thermally active panels.

Panel features

SIZE	WEIGHT	CODE
2200x600x27 mm	1.1 Kg	6100700



Pre-insulated pipe Ø 20 mm

PB pipe with oxygen barrier according to DIN 4726 EN 12319-2, Ø 20 mm, pipe insulation made of expanded polyethylene, thickness 6 mm. Reaction to fire class: BL-s2, d0. It is used to connect distributors with b!klimax manifolds.

TYPE	SIZE	CODE
red roll 50 m	Ø 20 mm	6200020
blu roll 50 m	Ø 20 mm	6201020
red 1 bar 4 m	Ø 20 mm	6202020
blu 1 bar 4 m	Ø 20 mm	6203020

Nota:
for further technical data see page 72



8-way Distributors

Pair of distributors made of plastic, specially shaped to guarantee easy connection with the pipes coming from b!klimax panels. These distributors are provided with anticondensation shells made of polystyrene or expanded polyethylene BL-s1, d0, push-fit pipe fittings for pipes Ø 6 mm and Ø 20 mm, and closing plastic bands.

MODEL	INSULATION	CODE
8-way open	polystyrene	6210040
8-way open	polyethylene	6210041
8-way terminal	polystyrene	6210050
8-way terminal	polyethylene	6210051



4-way Distributors

Pair of distributors made of plastic, specially shaped to guarantee easy connection with the pipes coming from b!klimax panels. These distributors are provided with anticondensation shells made of polystyrene or expanded polyethylene BL-s1, d0, push-fit pipe fittings for pipes Ø 6 mm and Ø 20 mm, and closing plastic bands.

MODEL	INSULATION	CODE
4-way open	polystyrene	6210060
4-way open	polyethylene	6210061
4-way terminal	polystyrene	6210070
4-way terminal	polyethylene	6210071



Straight Push-fit Fitting Ø 6 mm

Straight push-fit fitting used as connection for polybutylene pipes Ø 6 mm. It's provided with anticondensation insulation shells available in polystyrene or polyethylene BL-s1, d0.

SIZE	INSULATION	CODE
Ø 6 mm	polystyrene	6510006
Ø 6 mm	polyethylene	6510016
Ø 20 mm	polyethylene	6510026



TEE Push-fit Fitting 20-20-20 mm

TEE push-fit fitting used as connection for PB pipes Ø 20 mm. It's provided with anticondensation insulation shells available in polystyrene or polyethylene BL-s1, d0.

SIZE	INSULATION	CODE
Ø 20 mm	polystyrene	6510055
Ø 20 mm	polyethylene	6510056



Cross Push-fit Fitting 20-20-20-20 mm

This cross push-fit fitting is used as connection for polybutylene pipes Ø 20 mm. It's provided with anticondensation insulation shells available in polystyrene or polyethylene BL-s1, d0.

SIZE	INSULATION	CODE
Ø 20 mm	polystyrene	6510065
Ø 20 mm	polyethylene	6510066



Elbow Push-fit Fitting 20-20 mm

This ELBOW push-fit fitting is used as 90° shifting for polybutylene pipes Ø 20 mm. It's provided with polyethylene BL-s1, d0 insulation or without it.

SIZE	INSULATION	CODE
Ø 20 mm	--	6510075
Ø 20 mm	polyethylene	6510076

PRODUCTS THAT COMPOSE THE SYSTEM



Pre-insulated PB Pipe Ø 6 mm

PB pipe Ø 6 mm with oxygen barrier according to DIN 4726 EN 12319-2, pipe insulation made of expanded polyethylene, reaction to fire class BL-s1,d0, thickness 6 mm. It is used to connect b!klimax+ and Quadroto panels to the distributors.

SIZE	CODE
Ø 6 mm	6210006

Nota:
for further technical data see page 73



Lubricant for Push-fit Pipe Fittings

This lubricant is used to guarantee better insertion of the pipes into the fittings and better preservation of O-rings. (1 package every 75 circuits).

SIZE	CODE
20 ml	6603000



RDZ Retard 180 m

Retarder for gypsum plaster applications and bonding agents. Dosage: 0.5% of the water necessary to dilute the bonding agent (100 g in 20 L of water or 1 can every 50 m²). Useful for traditional b!klimax panels.

SIZE	CODE
1 liter	6602000



Closing Plugs for Outlets Ø 6 mm and Ø 20 mm

Plastic plugs are used to close the unused outlets in a distributor.

SIZE	CODE
Ø 6 mm	6510040
Ø 20 mm	6510050



Industry System Elbow

Elbow for 90° shifting with pipes Ø 20 mm.

SIZE	CODE
Ø 20 mm	1140025



Screw and Washer

55-mm screws and washers made of stainless steel. They are used to fix b!klimax panels to the metal grid.

SIZE	CODE
55 mm	6510005



b!klimax Perimeter belt

Edge insulation for b!klimax and b!klimax+ ceiling systems, made of closed-cell expanded polyethylene. It acts as thermo-acoustic insulation and it absorbs plasterboard ceiling expansions.

SIZE	CODE
h 150 mm	6603010



Spare parts kit

Replacement kit for b!klimax fittings and distributors including all the components needed to restore a pipe connection.

SIZE	CODE
for Ø 6 mm pipe	6510070
for Ø 20 mm pipe	6510080

THERMAL OUTPUT OF THE SYSTEM

Thermal output in heating - ceiling

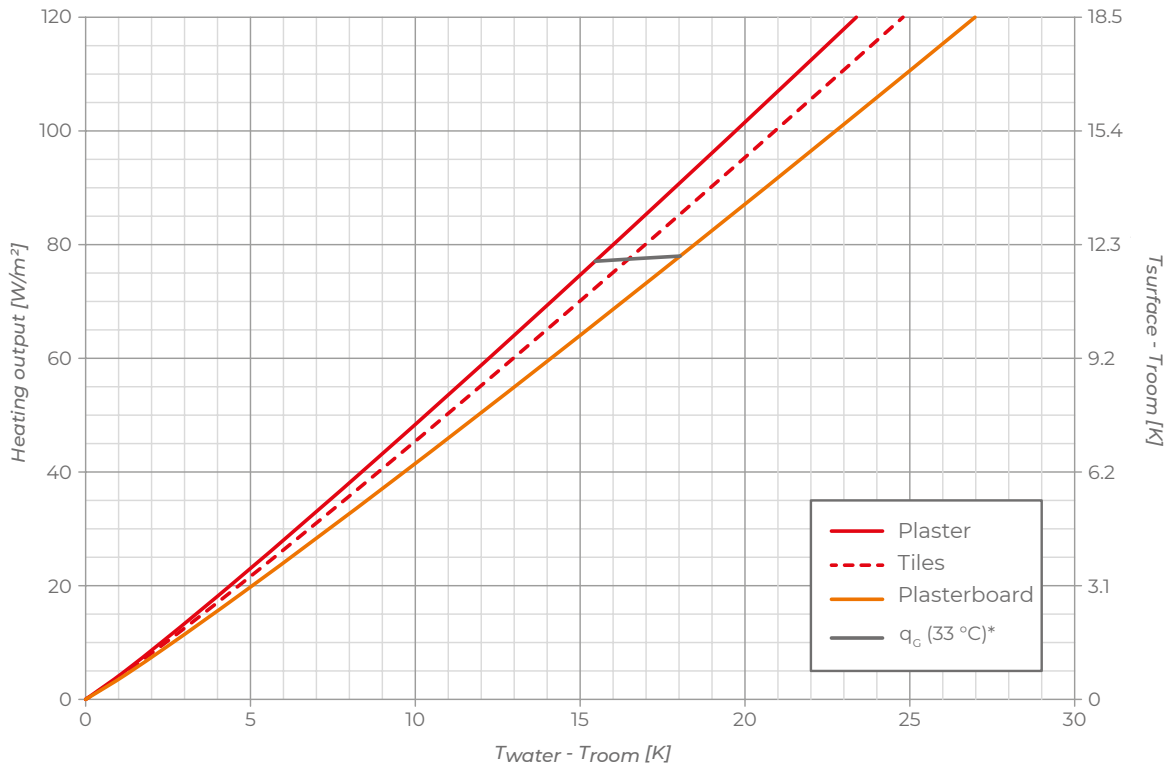

*valid only for room temperature= 20 °C

Thermal output in heating - wall

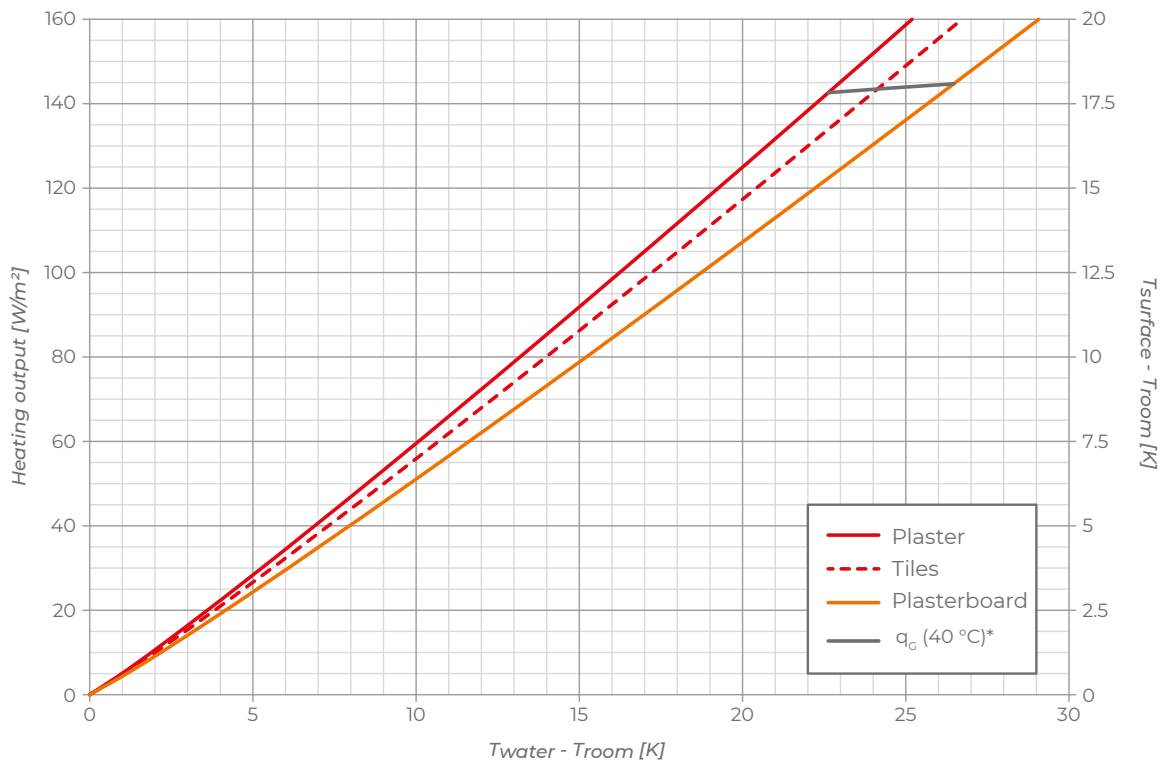

*valid only for room temperature= 20 °C

Thermal output in cooling - ceiling

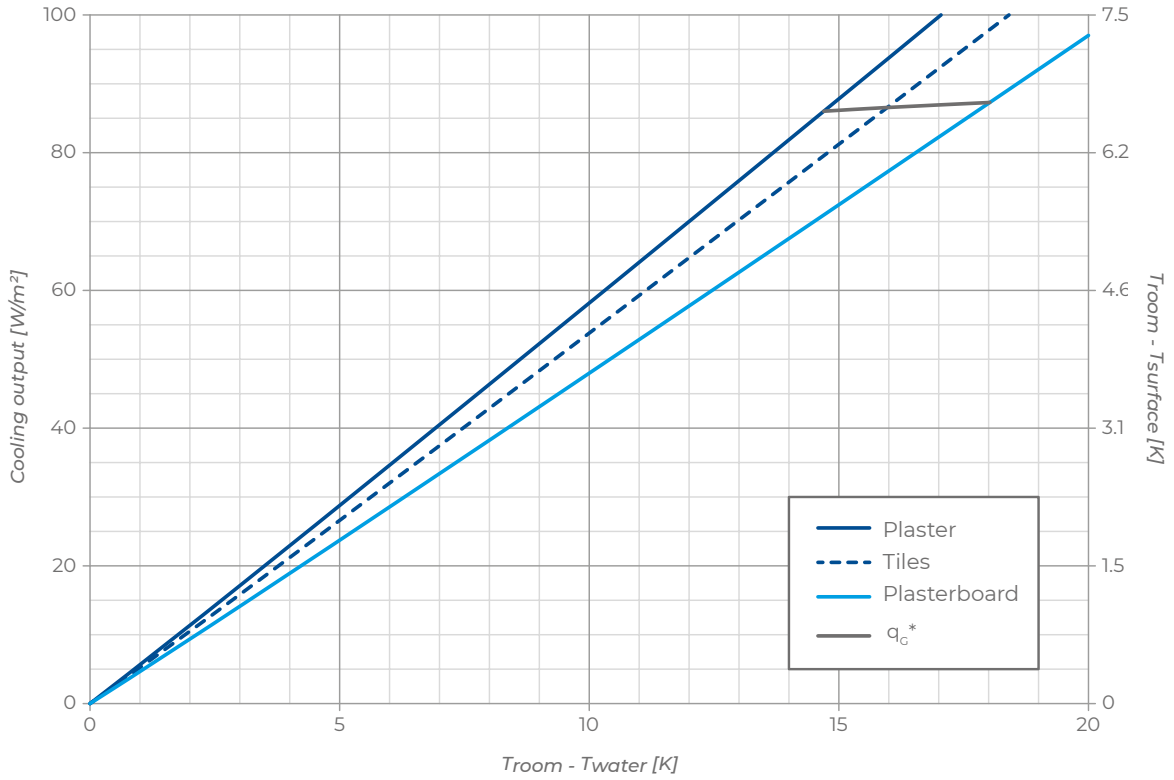

*valid only for room temperature= 26 °C 55% R.H.

Thermal output in cooling - wall

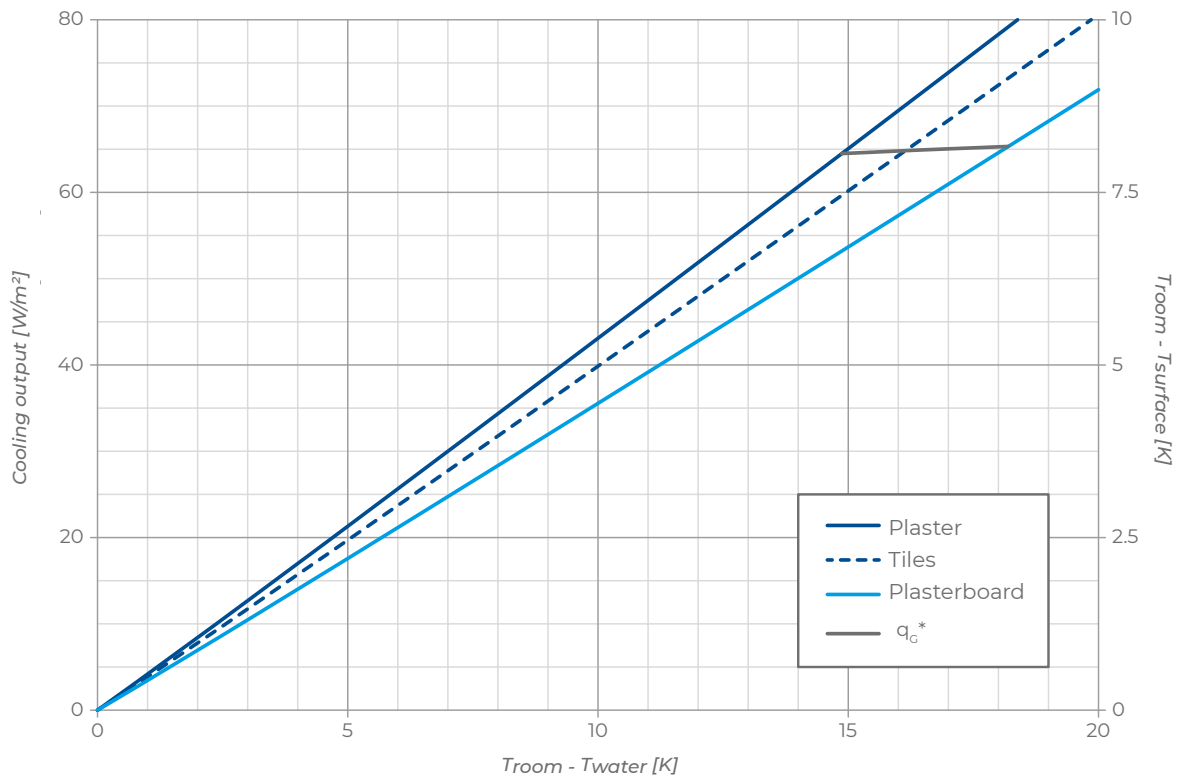

*valid only for room temperature= 26 °C 55% R.H.



b!klimax+ Twin Copper is a specific ceiling heating and cooling system for rooms in the commercial applications characterised by a very high thermal efficiency (certified by an accredited laboratory), excellent sound-absorbing properties and a pleasant aesthetic impact.

The central element of the system is the radiant island panel with sound-absorbing properties, to be installed on a suspension structure with M6 threaded rods or steel cord.

The metal radiant panel boxed in zinc-plated sheet iron is complete with \varnothing 12 mm copper coil housed in special aluminium profiles that act as thermal diffusers.

Characterised by a double emitting surface, it improves the performance of the system especially in locals with high heights and considerable thermal loads.

The system is completed with a flexible hose with push-fit fittings with stainless steel wire braid and oxygen barrier.

FEATURES

- High thermal performance
- Excellent acoustic performance
- Elegant and refined aesthetics
- Ceiling installation
- Low thermal inertia
- Suitable for commercial applications



PRODUCTS THAT COMPOSE THE SYSTEM

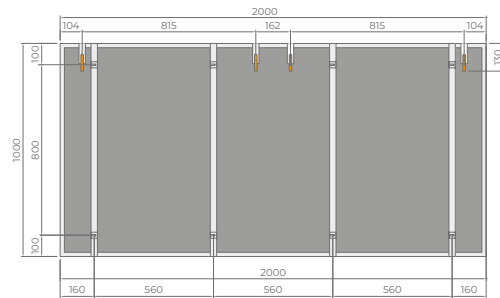
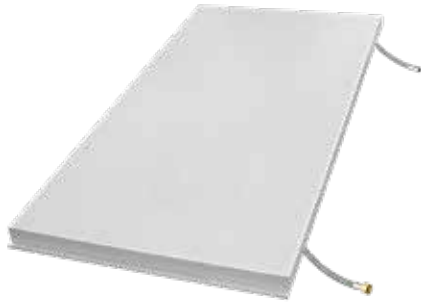

Panel features

SIZE	WEIGHT	CODE
1000x2000x30 mm	40.2 Kg	6146000

b!klimax+ Twin Copper radiant panel

The Twin Copper radiant panel is composed of a box-shaped metal ceiling in zinc-plated sheet iron with a microperforated surface on both sides, white post-painted RAL 9001 with a smooth 30 mm edge on the visible side. Inside the panel, 2 copper coils with a diameter of 12 mm are fixed on special shaped aluminium diffusers. The panel is provided with sound-absorbing polyester insulation and push-fit fittings for the hydraulic connection with flexible hoses.

Twin Copper panel characteristics	Value	Unit	Standard
Heating yields(Δt: 15K)	164	W/m ²	DIN EN 14037
Cooling yields (Δt: 8K)	97	W/m ²	DIN EN 14240
Elementary circuit flow rate	180	l/h	
Elementary circuit pressure loss	3000	DaPa	
Elementary panel circuits	0.5		

Insulation characteristics		Value	Unit	Standard
Material		Polyester		
Standard thickness		30	mm	UNI EN 823
Density		30	Kg / m ³	
Thermal conductivity 50°C	λ	0.037	W/(m · K)	
Fire reaction	Euroclass	B-s2, d0		UNI EN 13501
Grammage		900	g / m ²	
Finish		not smooth		

Metal panel characteristics	Value	Unit
Material	Zinc-plated steel 7/10 post-painted RAL 9001	
Length	2000	mm
Width	1000	mm
Height	30	mm
Thickness	0.7	mm
Smooth edge on all 4 sides	30	mm

Acoustic performance in place																			
f [Hz]	100	125	160	200	250	315	400	500	630	800	1000	1250	1600	2000	2500	3150	4000	5000	NRC
α -20 cm	0.38	0.49	0.14	0.43	0.52	0.48	0.82	1.00	0.70	0.82	0.63	0.82	1.00	0.47	0.36	0.67	0.36	0.61	0.65
α -50 cm	0.29	1.00	0.25	0.42	0.49	0.36	0.26	0.83	0.94	0.85	1.00	1.00	1.00	0.96	0.87	0.70	0.72	0.61	0.80

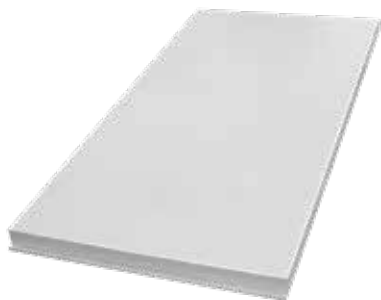

Passive metal panel

Twin Copper blank panel for suspension system with modular metal ceilings using threaded bars M6. It consists in post-painted metal tiles 1000x2000 mm (RAL 9001) with micro-perforated surface on both sides and plain border of 30 mm on the front side. Each blank panel is provided with sound-absorbing polyester insulation.

SIZE	WEIGHT	CODE
1000x2000x30 mm	21.8 Kg	6146001



Flexible Hose with Push-fit Fittings

Flexible hose with push-fit fittings for Twin Copper system, stainless steel wire braid, oxygen barrier, PN 10, suitable for Ø 12 mm. The hose is used to join the radiant panels in series.

SIZE	CODE
L= 500 Ø 12 - Ø 12	6145150
L= 1200 Ø 12 - Ø 12	6145155
L= 1700 Ø 12 - Ø 12	6145160
L= 750 Ø 12 - Ø ½" F	6145170
L= 1500 Ø 12 - Ø ½" F	6145175

■ THERMAL OUTPUT OF THE SYSTEM

Thermal output in heating - ceiling

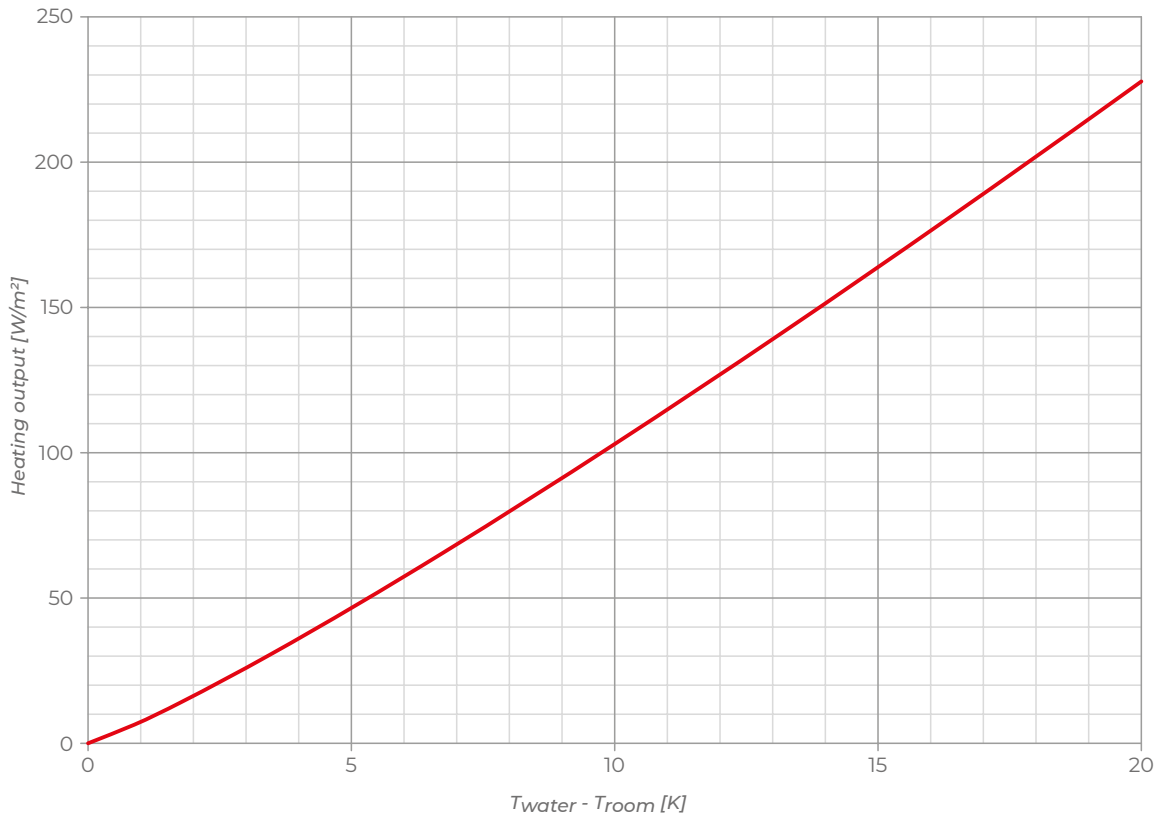

Thermal output in cooling - ceiling

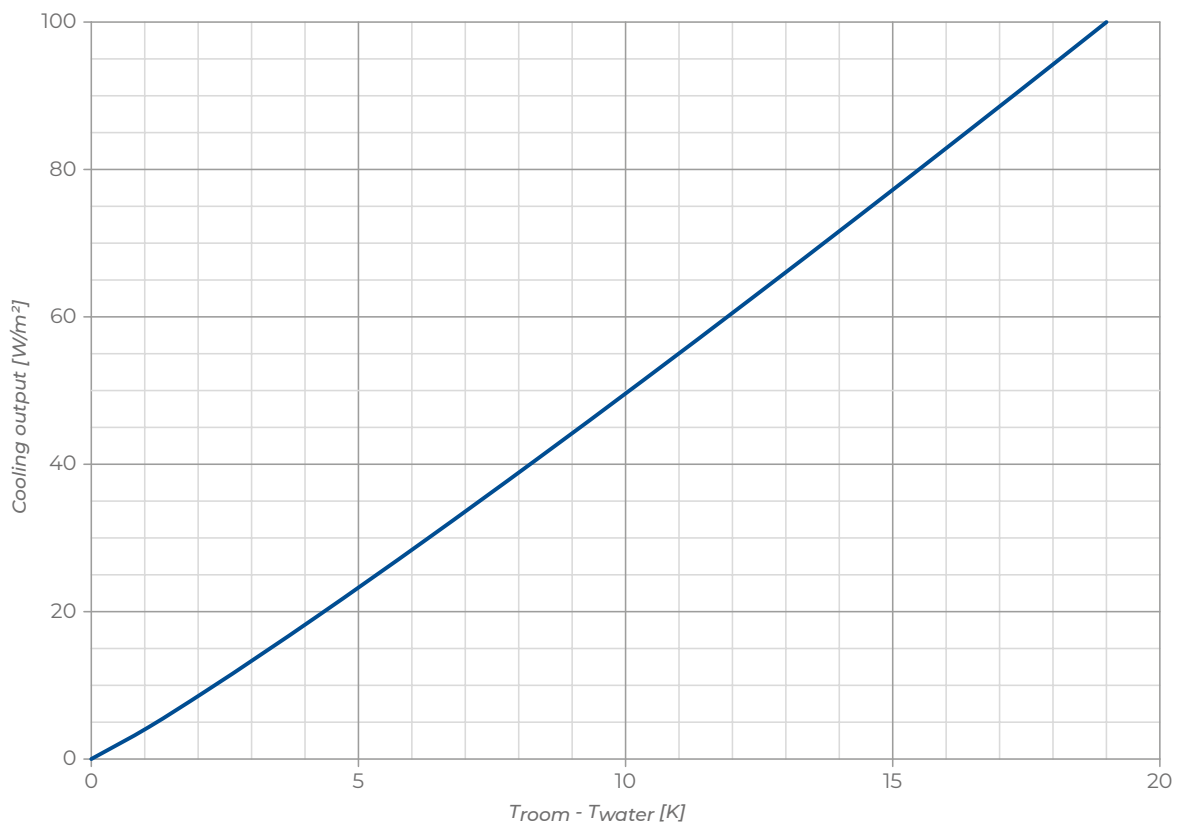



b!klimax+ Copper 8 is a specific ceiling heating and cooling system for rooms in the commercial applications characterised by a very high thermal output (certified by an accredited laboratory) thanks to the use of copper piping with an elliptical design.

The heart of the system is the metal radiant ceiling with rounded corners, micro-perforated surface and smooth 30 mm edge. The copper pipe \varnothing 8 mm is fixed to the ceiling by an aluminium diffuser with a push-fit fitting. The panel is available with polyester or glass-wool insulation.

The installation on a special hidden modular structure allows the panels to be opened with a tilting system ("trap door"), thus facilitating inspection and maintenance operations, and making it possible to exploit the gap between the ceiling and the radiant panels for the installation of other systems.

The system is completed by the manifold, the distributors, the fittings, the pre-insulated polybutylene pipe \varnothing 20 mm for the connection of the distributors to the manifold and the PE-RT pipe \varnothing 8 mm with insulation for the connection of the panels to the distributors.

FEATURES

- Ceiling installation
- Very high thermal performance
- Copper pipe
- Installation on a hidden metal structure
- Insulating layer of polystyrene or rockwool
- Specific for commercial applications
- Inspectionable false ceiling



SECTION OF THE SYSTEM

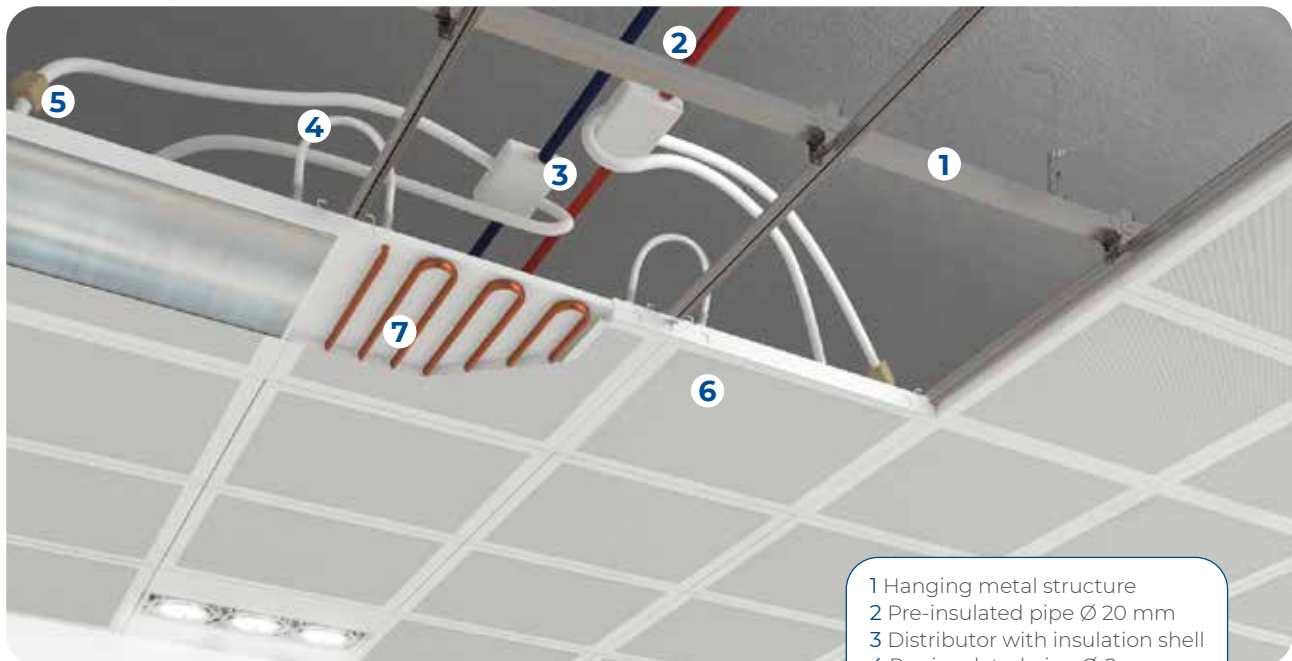

- 1 Hanging metal structure
- 2 Pre-insulated pipe \varnothing 20 mm
- 3 Distributor with insulation shell
- 4 Pre-insulated pipe \varnothing 8 mm
- 5 Fittings with insulation shell
- 6 Copper 8 panel
- 7 Copper pipe \varnothing 8 mm

SUPPORT STRUCTURE

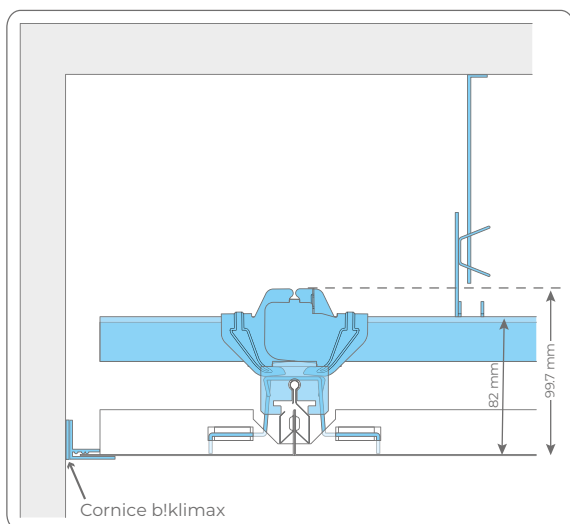

The **b!klimax+ Copper 8** metal radiant panels are designed to be ceiling installed on a special hanging and hidden metal support frame (double structure with Winger by Atena S.p.A.). The use of the patented “Winger” coupling facilitates the assembly and guarantees a perfect installation. The structure can be equipped with a special “anti-seismic kit” to meet the safety and stability requirements of the false ceiling in all areas with high seismic risk.



CUSTOMIZED ACTIVATION

The radiant technology used in the Copper 8, Quadrotti HP and Metal b!klimax+ Quadrotti systems can be adapted to a wide range of commercially available ceilings with a unique and personalized result.

For this reason, **after a feasibility analysis**, we offer a service of just creating the radiant activation of metal ceiling mounts other than the versions available in the catalogue that can be procured directly from our company or supplied by the customer on a subcontract basis.

For further information, please contact your local agent or contact us by writing to info@rdz.it

■ PRODUCTS THAT COMPOSE THE SYSTEM

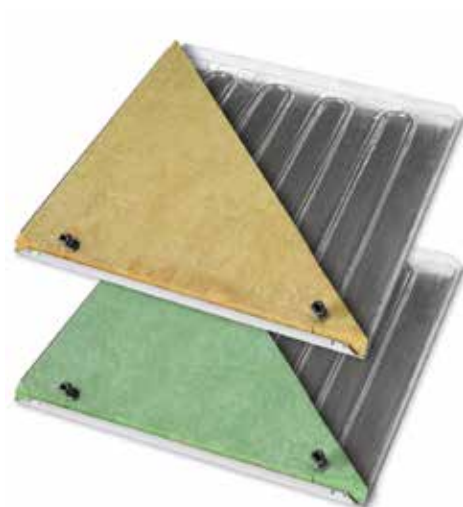

Panel features

Dimensions: 600x600x40 mm

INSULATION	WEIGHT	CODE
Polyester	2.5 Kg	6145620
Glass wool	2.6 Kg	6145625

Copper 8 radiant metal panel

The Copper 8 radiant panel consists in 5/10 steel post-painted RAL 9016 tiles with a swinging (“trap-door”) opening system, with micro-perforated surface, plain border of 30 mm and bevelled edge. The Ø 8 mm elliptical copper tubing is fixed to the ceiling via an aluminium diffuser with a push-fit fitting. The panel is available with polyester insulation (fire resistance class B-s2, d0) or glass-wool (fire resistance class A1) insulation.

Thermal performance Copper 8	Value	Unit	Standard
Heating (Δt : 15K)	120	W/m ²	DIN EN 14037
Cooling (Δt : 8K)	91	W/m ²	DIN EN 14240

Metal ceiling characteristics	Value	Unit	Standard
Type	Bevelled-edge panel with trap-door opening		
Material	Post-painted steel		
Length	600	mm	
Width	600	mm	
Height	27	mm	
Thickness	0.5	mm	
Emission of dangerous substances	nothing		EN 13964
Bending strength	class 1		
Duration	class C		

Polyester panel characteristics		Value	Unit	Standard
Size of insulating panel		596x596	mm	UNI EN 822
Standard thickness		30	mm	UNI EN 823
Density		30	Kg / m ³	
Thermal conductivity	λ	0.036	W/(m · K)	UNI EN 12667 / ISO 8302
Declared thermal conductivity	λd	0.038	W/(m · K)	UNI EN 12667 / EN ISO 10456
Airflow resistance		3.593	Pa · s / m ²	UNI EN 29503
Water vapour diffusion resistance factor	μ	3.2		UNI EN 12086
Dimensional stability (+23°C , 90% U.R. , 48h)	Length	- 0.02	%	UNI EN 1604
	Width	0.02		
	Thickness	- 0.12		
Lower heating value		21600	kJ/kg	
Specific heat		1.18	kJ/kg K	UNI EN ISO 11357-1 / ISO357-2
Fire reaction	Euroclass	B - s2, d0		UNI EN 13501
Limit of operating temperature		-40 ÷ +90	°C	

Glass-wool panel characteristics		Value	Unit	Standard
Size of insulating panel		596x596	mm	UNI EN 822
Standard thickness		30	mm	UNI EN 823
Density		30	Kg / m ³	
Thermal conductivity 50°C	λ	0.039	W/(m · K)	
Water vapour diffusion resistance factor	μ	Limitless from a practical point of view		UNI EN 12086
Melting temperature		900	°C	DIN 4102/T17
Specific heat		1030	kJ/kg K	EN 12524
Fire reaction	Euroclass	A1		UNI EN 13501
Limit of operating temperature		≤ 250	°C	

Pipe characteristics	Value	Unit	Diffuser characteristics	Value	Unit
Material	EN 12735-2 Annealed Copper Cu-DHP CW24A EN 12735-2 Light Y040		Material	aluminium	
Diameter	8	mm	Length	580	mm
Thickness	0.75	mm	Width	580	mm
Circuit length	4360	mm	Circuit length	4360	mm



Blank metal panel

It consists in 5/10 steel post-painted (RAL 9016) tiles with a swinging ("trap-door") opening system, with microperforated surface, plain border of 30 mm and bevelled edge. Complete with polyester insulation (fire reaction class B-s2, d0) or glass-wool (fire reaction class A1).

Metal ceiling characteristics size 600x600x40 mm

INSULATION	WEIGHT	CODE
Polyester	2.0 Kg	6145621
Glass-wool	2.1 Kg	6145626



Pre-insulated pipe Ø 20 mm

PB pipe with oxygen barrier according to DIN 4726 EN 12319-2, Ø 20 mm, pipe insulation made of expanded polyethylene, thickness 6 mm. Reaction to fire class: BL-s2, d0. It is used to connect distributors with b!klimax manifolds.

TYPE	SIZE	CODE
red roll 50 m	Ø 20 mm	6200020
blu roll 50 m	Ø 20 mm	6201020
red 1 bar 4 m	Ø 20 mm	6202020
blu 1 bar 4 m	Ø 20 mm	6203020

Note:
for further technical data see page 72



2-way Distributors Ø 8 mm

Pair of distributors made of plastic, specially shaped to guarantee easy connection with the pipes coming from Copper 8 and Quadrotto HP tiles. These distributors are provided with anti-condensation shells made of polystyrene or expanded polyethylene BL-s1, d0, push-fit pipe fittings for pipes Ø 8 mm and Ø 20 mm, and closing plastic bands.

MODEL	INSULATION	CODE
2-way open	polystyrene	6210080
2-way open	polyethylene	6210082



4-way Distributors Ø 8 mm

Pair of distributors made of plastic, specially shaped to guarantee easy connection with the pipes coming from Copper 8 and Quadrotto HP tiles. These distributors are provided with anti-condensation shells made of polystyrene or expanded polyethylene BL-s1, d0, push-fit pipe fittings for pipes Ø 8 mm and Ø 20 mm, and closing plastic bands.

MODEL	INSULATION	CODE
4-way open	polystyrene	6210081
4-way open	polyethylene	6210083



Straight Push-fit Fitting

Straight push-fit fitting used as connection for polybutylene pipes Ø 8 mm. Transparent version. Condensation shells made of polyethylene BL-s1, d0.

SIZE	INSULATION	CODE
Ø 8 mm	polyethylene	6510018
Ø 20 mm	polyethylene	6510026



TEE Push-fit Fitting 20-20-20 mm

TEE push-fit fitting used as connection for PB pipes Ø 20 mm. It's provided with anticondensation insulation shells available in polystyrene or polyethylene BL-s1, d0.

SIZE	INSULATION	CODE
Ø 20 mm	polystyrene	6510055
Ø 20 mm	polyethylene	6510056



Cross Push-fit Fitting 20-20-20-20 mm

This cross push-fit fitting is used as connection for polybutylene pipes Ø 20 mm. It's provided with anticondensation insulation shells available in polystyrene or polyethylene BL-s1, d0.

SIZE	INSULATION	CODE
Ø 20 mm	polystyrene	6510065
Ø 20 mm	polyethylene	6510066



Elbow Push-fit Fitting 20-20 mm

This ELBOW push-fit fitting is used as 90° shifting for polybutylene pipes Ø 20 mm. It's provided with polyethylene BL-s1, d0 insulation or without it.

SIZE	INSULATION	CODE
Ø 20 mm	z - -	6510075
Ø 20 mm	polyethylene	6510076

PRODUCTS THAT COMPOSE THE SYSTEM



PE-RT pipe Ø 8 mm

PE-RT pipe Ø 8 mm with oxygen barrier according to DIN 4726 DIN EN ISO 21003-2, thickness 1 mm. It is used to connect b!klimax+ Copper 8 and Quadrotto HP tiles with the distributors.

SIZE	CODE
Ø 8 mm	6210018

Note:
for further technical data see page 74



Insulation for PE-RT pipe Ø 8 mm

Insulation for PE-RT pipe Ø 8 mm made of expanded polyethylene, thickness 6 mm. Reaction to fire class: BL -s1, d0.

SIZE	CODE
Ø 8 mm	6320008



Lubricant for Push-fit Pipe Fittings

This lubricant is used to guarantee better insertion of the pipes into the fittings and better preservation of O-rings. (1 package every 75 circuits).

SIZE	CODE
20 ml	6603000



Closing Plugs for Outlets Ø 8 mm and Ø 20 mm

Plastic plugs are used to close the unused outlets in a distributor.

SIZE	CODE
Ø 8 mm	6510041
Ø 20 mm	6510050



Industry System Elbow

Elbow for 90° shifting with pipes Ø 20 mm.

SIZE	CODE
Ø 20 mm	1140025



Spare parts kit

Replacement kit for b!klimax fittings and distributors including all the components needed to restore a pipe connection.

SIZE	CODE
for pipe Ø 8 mm	6510071
for pipe Ø 20 mm	6510080

THERMAL OUTPUT OF THE SYSTEM

Thermal output in heating - ceiling

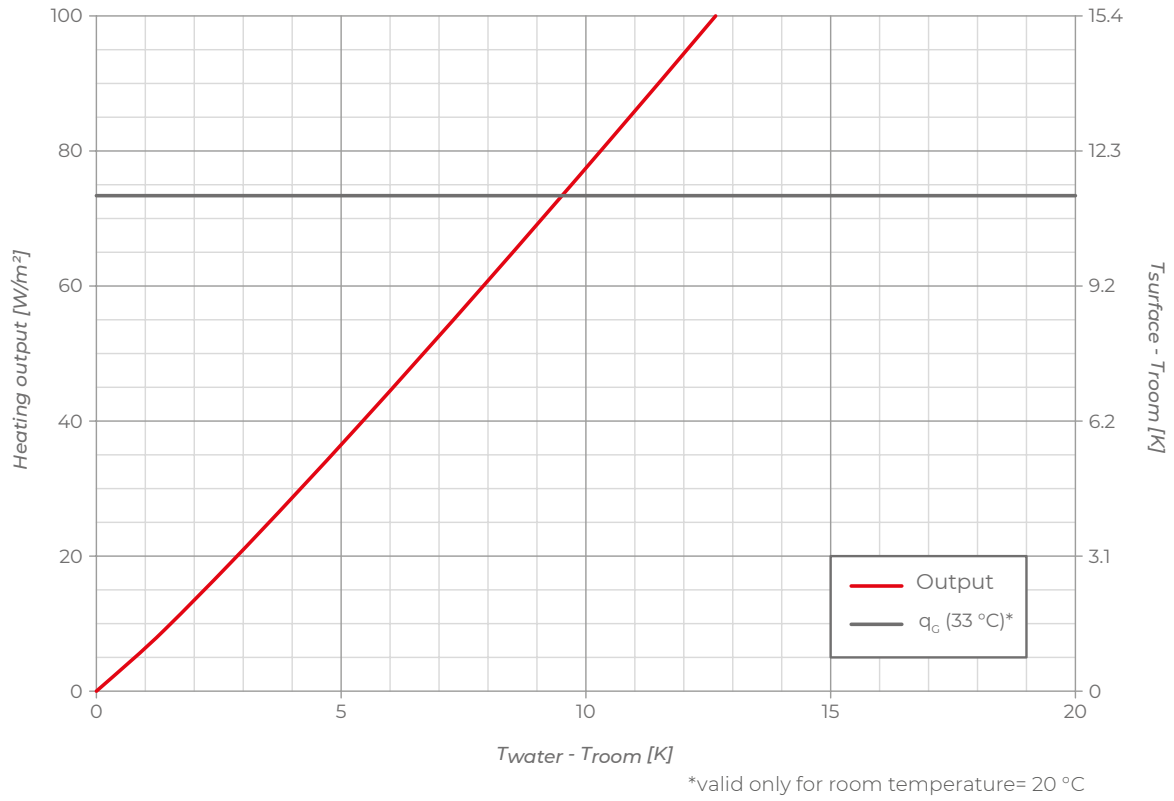

Thermal output in cooling - ceiling

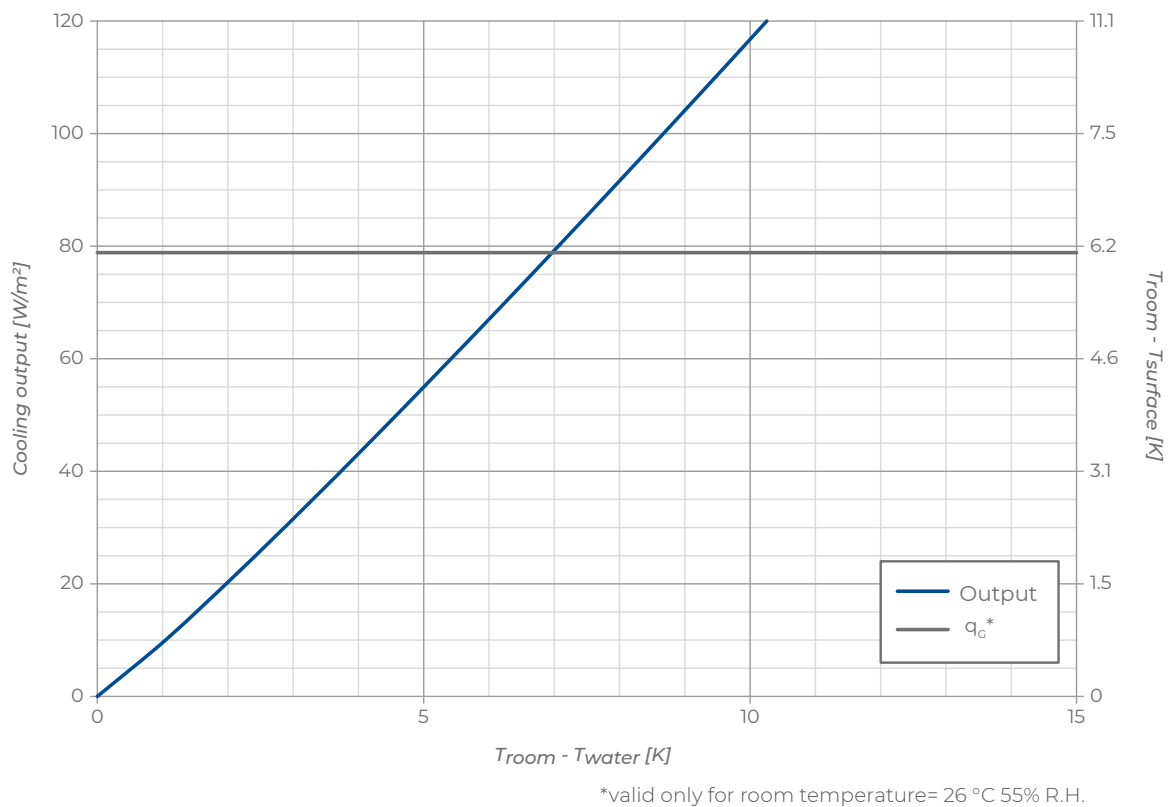

B!KLIMAX+ QUADROTTI HP SYSTEM



b!klimax+ Quadrotti HP is a specific ceiling heating and cooling system for commercial applications, characterised by high performance certified by an accredited laboratory.

The central element of the system is the metal radiant ceiling with rounded corners and microperforated surface with 30 mm smooth edge. The hydraulic circuit in PE-RT Ø 8 mm is fixed to the ceiling by an aluminium diffuser, equipped with a push-fit fitting and a barrier against the diffusion of oxygen. Thermal insulation is provided by a layer of polyester fibre or glass-wool.

Designed for installation on its own concealed modular structure, b!klimax+ Quadrotti HP allows the panels to be opened like a trapdoor, making inspection and maintenance work easier. The gap between the ceiling and the radiant panels can also be used for the installation of other systems.

The system is completed by the manifold, the distributors, the fittings, the pre-insulated polybutylene pipe Ø 20 mm for the connection of the distributors to the manifold and the PE-RT pipe Ø 8 mm with insulation for the connection of the panels to the distributors.

FEATURES

- Ceiling installation
- Certified high heat performances
- PE-RT pipe Ø 8 mm
- Installation on a hidden metal structure
- Polyester or glass-wool insulation
- Specific for commercial applications
- Inspectionable false ceiling



SECTION OF THE SYSTEM

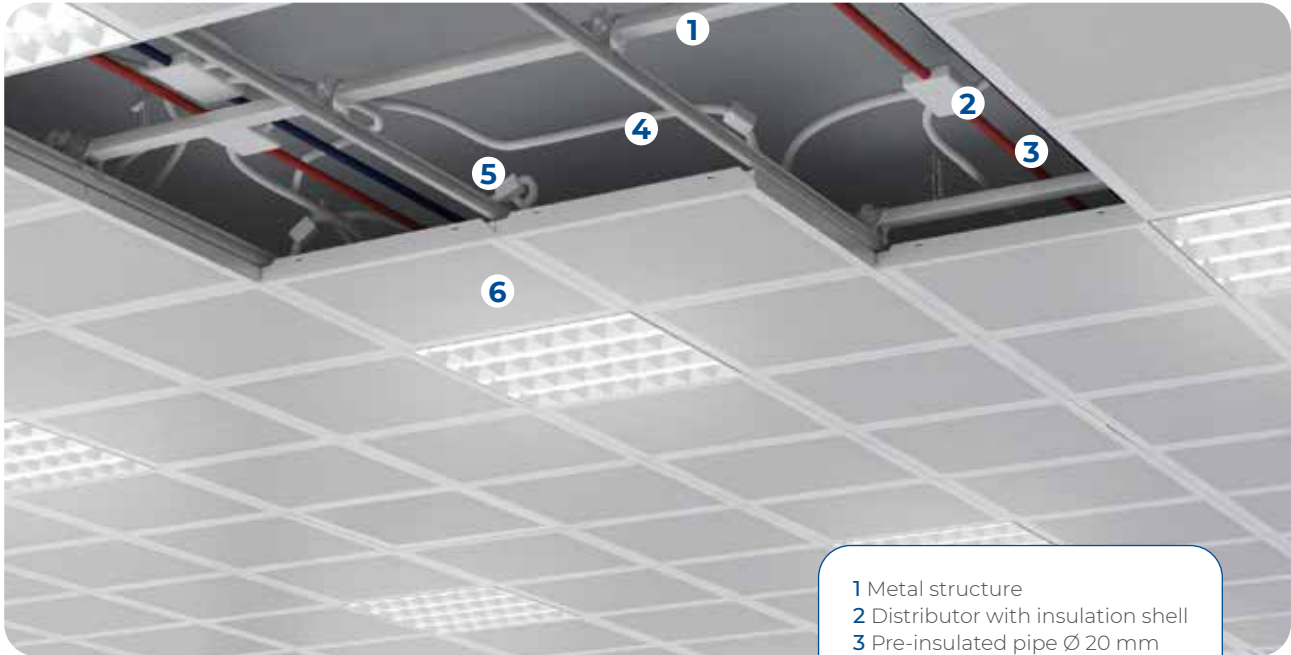

- 1 Metal structure
- 2 Distributor with insulation shell
- 3 Pre-insulated pipe \varnothing 20 mm
- 4 Pre-insulated pipe \varnothing 8 mm
- 5 Fitting with insulation shell
- 6 Quadrotto HP panel

SUPPORT STRUCTURE

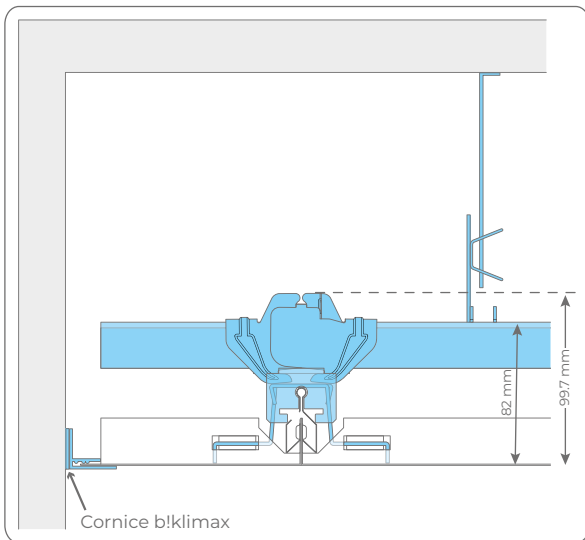

b!klimax+ Quadrotti HP metal radiant panels are designed to be installed on the ceiling on a special metal support frame that is suspended and concealed (double continental structure with Winger by Atena S.p.A.).

The use of the patented “Winger” fitting facilitates the assembly and guarantees a professional installation.

The structure can be equipped with a special “anti-seismic kit” to meet the safety and stability requirements of the false ceiling in all areas with high seismic risk.



CUSTOMIZED ACTIVATION

The radiant technology used in the Copper 8, Quadrotti HP and Metal b!klimax+ Quadrotti systems can be adapted to a wide range of commercially available ceilings with a unique and personalized result.

For this reason, **after a feasibility analysis**, we offer a service of just creating the radiant activation of metal ceiling mounts other than the versions available in the catalogue that can be procured directly from our company or supplied by the customer on a subcontract basis.

For further information, please contact your local agent or contact us by writing to info@rdz.it

PANEL FEATURES



Panel features

Dimensions: 600x600x40 mm

INSULATION	WEIGHT	CODE
Polyester	2.7 Kg	6140620
Glass wool	2.8 Kg	6140625

Quadrotto HP metal radiant panel 600x600

Quadrotto HP radiant panel consists in 5/10 steel post-painted RAL 9016 tiles with a swinging (“trap-door”) opening system, with micro-perforated surface, plain border of 30 mm and bevelled edge. The Ø 8 mm PE-RT pipe with a DIN oxygen diffusion barrier and push-fit fitting is attached to the ceiling via a thick, highly conductive aluminium diffuser.

The panel is available with polyester insulation (fire resistance class B-s2, d0) or glass-wool (fire resistance class A1) insulation.

Quadrotto HP characteristics	Value	Unit	Standard
Heating (Δt : 15K)	99	W/m ²	DIN EN 14037
Cooling (Δt : 8K)	73	W/m ²	DIN EN 14240

Metal ceiling characteristics	Value	Unit	Standard
Type	Bevelled-edge panel with trap-door opening		
Material	Post-painted steel		
Length	600	mm	
Width	600	mm	
Height	27	mm	
Thickness	0.5	mm	
Emission of dangerous substances	nothing		EN 13964
Bending strength	Class 1		
Duration	Class C		

Diffuser characteristics	Value	Unit
Material	Aluminium 10/10	
Length	560	mm
Width	560	mm

Polyester panel characteristics		Value	Unit	Standard
Size of insulating panel		596x596	mm	UNI EN 822
Standard thickness		30	mm	UNI EN 823
Density		30	Kg / m ³	
Thermal conductivity	λ	0.036	W/(m · K)	UNI EN 12667 / ISO 8302
Declared thermal conductivity	λ _d	0.038	W/(m · K)	UNI EN 12667 / EN ISO 10456
Airflow resistance		3.593	Pa · s / m ²	UNI EN 29503
Water vapour diffusion resistance factor		μ	3.2	UNI EN 12086
Dimensional stability (+23°C , 90% U.R. , 48h)	Length	- 0.02	%	UNI EN 1604
	Width	0.02		
	Thickness	- 0.12		
Lower heating value		21600	kJ/kg	
Specific heat		1.18	kJ/kg K	UNI EN ISO 11357-1 / ISO357-2
Fire reaction	Euroclass	B - s2, d0		UNI EN 13501
Limit of operating temperature		-40 ÷ +90	°C	

Glass-wool panel characteristics		Value	Unit	Standard
Size of insulating panel		596x596	mm	UNI EN 822
Standard thickness		30	mm	UNI EN 823
Density		30	Kg / m ³	
Thermal conductivity 50°C	λ	0.039	W/(m · K)	
Water vapour diffusion resistance factor	μ	Limitless from a practical point of view		UNI EN 12086
Melting temperature		900	°C	DIN 4102/T17
Specific heat		1030	kJ/kg K	EN 12524
Fire reaction	Euroclass	A1		UNI EN 13501
Limit of operating temperature		≤ 250	°C	

PE-RT pipe characteristics					
Application field		CLASS 4	For use with hot and cold water	T _{max} 70 °C	Pressure 8 bar
		CLASS 5	For use with hot and cold water	T _{max} 90 °C	Pressure 6 bar
Outside diam. (mm)	Thickness (mm)	Circuit Length (mm)		Weight (g/m)	Water content (l/m)
8	1	4550		22	0,028



Blank Panel

Blank panel for ceiling mounting on hidden modular structure. It consists in 5/10 steel post-painted (RAL 9016) tiles with a swinging ("trap-door") opening system, with micro-perforated surface, plain border of 30 mm and bevelled edge. The panel is available with polyester insulation (reaction to fire classification: B-s2, d0) or glass-wool (fire class A1).

Panel features

Dimensions: 600x600x40 mm

INSULATION	WEIGHT	CODE
Polyester	2.0 Kg	6145621
Glass-wool	2.1 Kg	6145626

■ THERMAL OUTPUT OF THE SYSTEM

Thermal output in heating - ceiling

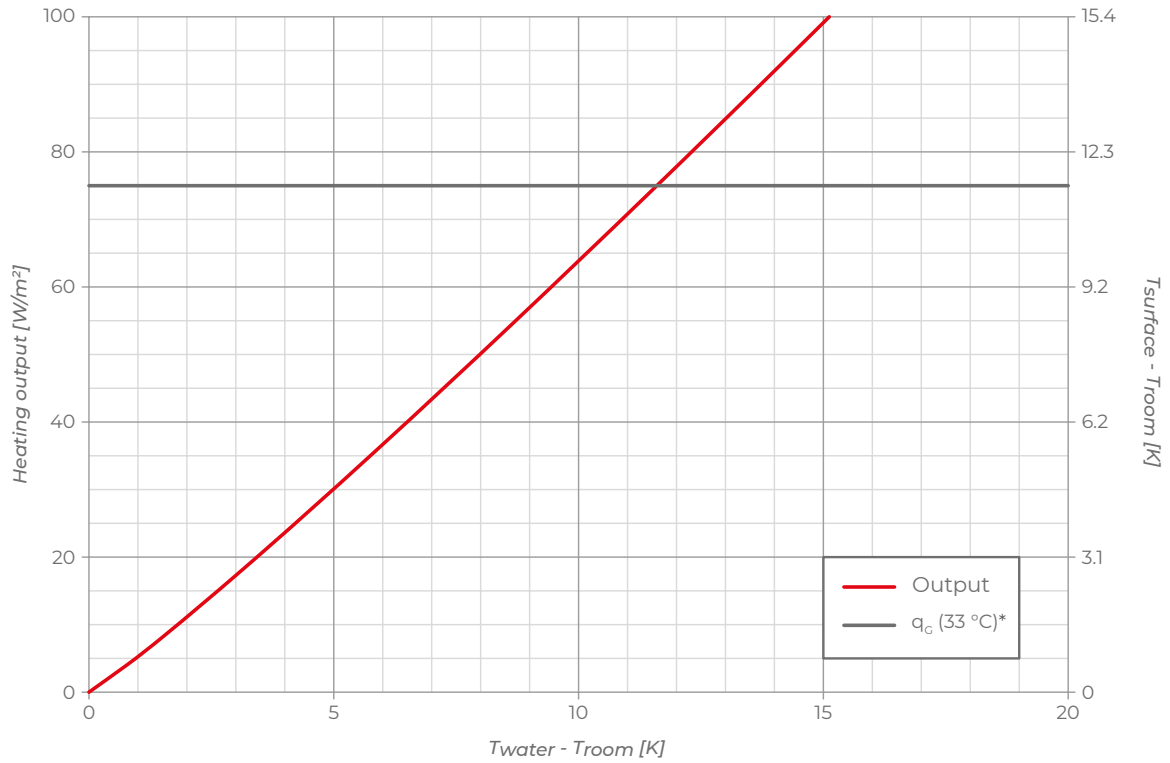

*valid only for room temperature= 20 °C

Thermal output in cooling - ceiling

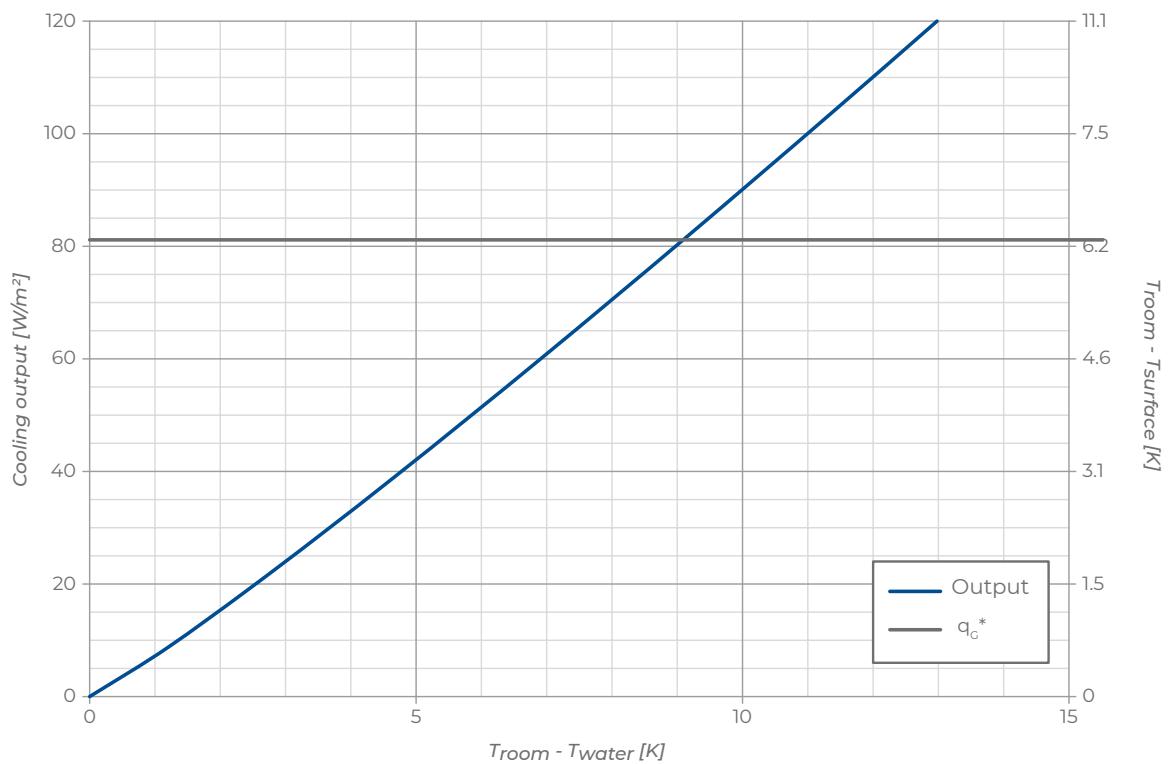

*valid only for room temperature= 26 °C 55% R.H.



Pre-insulated pipe Ø 20 mm

PB pipe with oxygen barrier according to DIN 4726 EN 12319-2, Ø 20 mm, pipe insulation made of expanded polyethylene, thickness 6 mm. Reaction to fire class: BL-s2, d0. It is used to connect distributors with b!klimax manifolds.

TYPE	SIZE	CODE
red roll 50 m	Ø 20 mm	6200020
blu roll 50 m	Ø 20 mm	6201020
red 1 bar 4 m	Ø 20 mm	6202020
blu 1 bar 4 m	Ø 20 mm	6203020

Note:
for further technical data see page 72



2-way Distributors Ø 8 mm

Pair of distributors made of plastic, specially shaped to guarantee easy connection with the pipes coming from Copper 8 and Quadrotto HP tiles. These distributors are provided with anti-condensation shells made of polystyrene or expanded polyethylene BL-s1, d0, push-fit pipe fittings for pipes Ø 8 mm and Ø 20 mm, and closing plastic bands.

MODEL	INSULATION	CODE
2-way open	polystyrene	6210080
2-way open	polyethylene	6210082



4-way Distributors Ø 8 mm

Pair of distributors made of plastic, specially shaped to guarantee easy connection with the pipes coming from Copper 8 and Quadrotto HP tiles. These distributors are provided with anti-condensation shells made of polystyrene or expanded polyethylene BL-s1, d0, push-fit pipe fittings for pipes Ø 8 mm and Ø 20 mm, and closing plastic bands.

MODEL	INSULATION	CODE
4-way open	polystyrene	6210081
4-way open	polyethylene	6210083



Straight Push-fit Fitting

Straight push-fit fitting used as connection for polybutylene pipes Ø 8 mm. Transparent version. Condensation shells made of polyethylene BL-s1, d0.

SIZE	INSULATION	CODE
Ø 8 mm	polyethylene	6510018
Ø 20 mm	polyethylene	6510026



TEE Push-fit Fitting 20-20-20 mm

TEE push-fit fitting used as connection for PB pipes Ø 20 mm. It's provided with anticondensation insulation shells available in polystyrene or polyethylene BL-s1, d0.

SIZE	INSULATION	CODE
Ø 20 mm	polystyrene	6510055
Ø 20 mm	polyethylene	6510056



Cross Push-fit Fitting 20-20-20-20 mm

This cross push-fit fitting is used as connection for polybutylene pipes Ø 20 mm. It's provided with anticondensation insulation shells available in polystyrene or polyethylene BL-s1, d0.

SIZE	INSULATION	CODE
Ø 20 mm	polystyrene	6510065
Ø 20 mm	polyethylene	6510066



Elbow Push-fit Fitting 20-20 mm

This ELBOW push-fit fitting is used as 90° shifting for polybutylene pipes Ø 20 mm. It's provided with polyethylene BL-s1, d0 insulation or without it.

SIZE	INSULATION	CODE
Ø 20 mm	- -	6510075
Ø 20 mm	polyethylene	6510076

PRODUCTS THAT COMPOSE THE SYSTEM



PE-RT pipe Ø 8

PE-RT pipe Ø 8 mm with oxygen barrier according to DIN 4726 DIN EN ISO 21003-2, thickness 1 mm. It is used to connect b!klimax+ Copper 8 and Quadrotto HP tiles with the distributors.

SIZE	CODE
Ø 8 mm	6210018

Note:
for further technical data see page 74



Insulation for PE-RT pipe Ø 8 mm

Insulation for PE-RT pipe Ø 8 mm made of expanded polyethylene, thickness 6 mm. Reaction to fire class: BL -s1, d0.

SIZE	CODE
Ø 8 mm	6320008



Lubricant for Push-fit Pipe Fittings

This lubricant is used to guarantee better insertion of the pipes into the fittings and better preservation of O-rings. (1 package every 75 circuits).

SIZE	CODE
20 ml	6603000



Closing Plugs for Outlets Ø 8 and Ø 20 mm

Plastic plugs are used to close the unused outlets in a distributor.

SIZE	CODE
Ø 8 mm	6510041
Ø 20 mm	6510050



Industry System Elbow

Elbow for 90° shifting with pipes Ø 20 mm.

SIZE	CODE
Ø 20 mm	1140025



Spare parts kit

Replacement kit for b!klimax fittings and distributors including all the components needed to restore a pipe connection.

SIZE	CODE
for Ø 8 mm pipe	6510071
for Ø 20 mm pipe	6510080



b!klimax+ Quadrotti is a ceiling heating and cooling system specifically designed for the commercial applications, consisting of metal ceilings or plasterboard panels onto which, by an aluminium diffuser, the \varnothing 6 mm pipe is fixed. Thermal insulation is provided by a layer of polystyrene or rockwool.

The metal version, available in 600x600 mm or 1200x600 mm, consists of post-painted steel radiant ceilings with rounded corners and microperforated surface with 20 mm smooth edge; the plasterboard version consists of a RAL 9003 white plasterboard sheet with high performance in terms of light reflection and soundproof performances.

The installation on a metal structure for false ceilings with inverted T profiles allows the cavity to be inspected and can be used to hide other systems.

The system is completed with the manifold, the distributors, the fittings, the pre-insulated polybutylene pipe \varnothing 20 mm for connecting the distributors to the manifold and the pre-insulated PB pipe \varnothing 6 mm for connecting the squares to the distributors.

FEATURES

- Ceiling installation
- Installation on metal structure for false ceiling with inverted T-profiles
- Polystyrene or rockwool insulation
- Specific for commercial applications
- Inspectionable false ceiling



SECTION OF THE SYSTEM

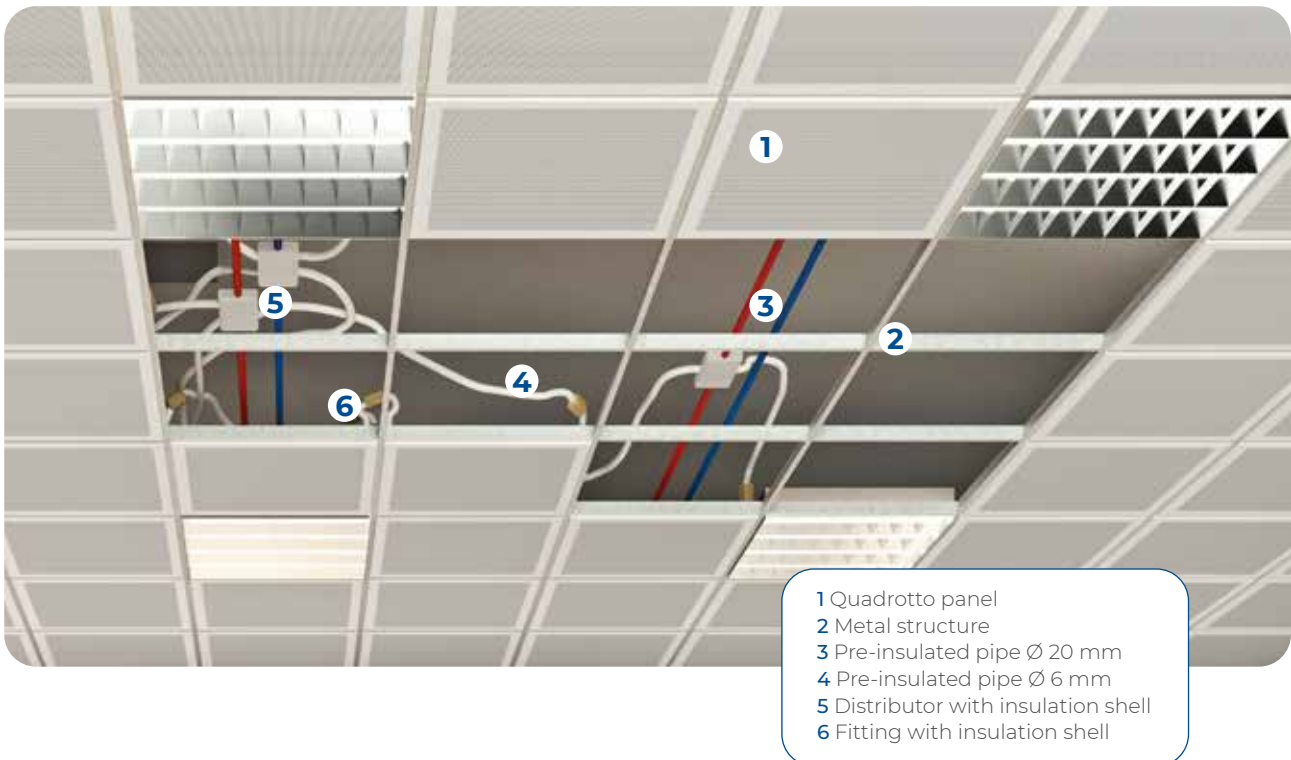

- 1 Quadrotto panel
- 2 Metal structure
- 3 Pre-insulated pipe Ø 20 mm
- 4 Pre-insulated pipe Ø 6 mm
- 5 Distributor with insulation shell
- 6 Fitting with insulation shell

SUPPORT STRUCTURE

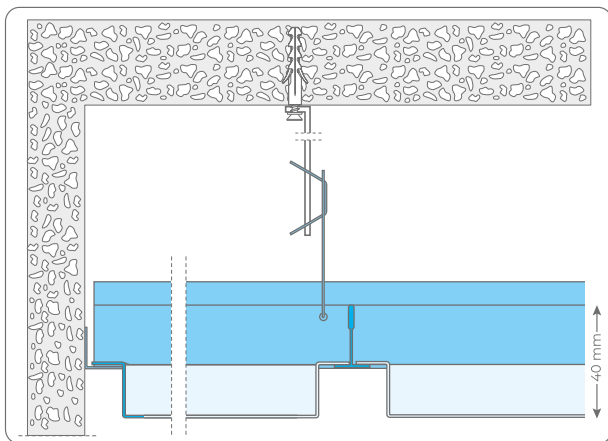

The **b!klimax+ Quadrotti** metal radiant panels are designed to be installed on the ceiling on a T-shaped metal support frame with a 15 mm base that emphasises its three-dimensionality, guaranteeing excellent aesthetic performance of the system. The structure can be equipped with a special “anti-seismic kit” to respond to the safety and stability requirements of the ceiling in all areas with high seismic risk.



CUSTOMIZED ACTIVATION

The radiant technology used in the Copper 8, Quadrotti HP and Metal b!klimax+ Quadrotti systems can be adapted to a wide range of commercially available ceilings with a unique and personalized result.

For this reason, **after a feasibility analysis**, we offer a service of just creating the radiant activation of metal ceiling mounts other than the versions available in the catalogue that can be procured directly from our company or supplied by the customer on a subcontract basis.

For further information, please contact your local agent or contact us by writing to info@rdz.it

PRODUCTS THAT COMPOSE THE SYSTEM

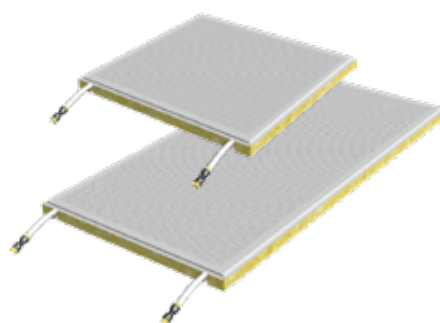
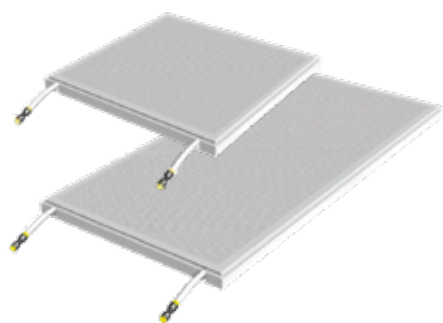

Polystyrene Quadrotto features

SIZE	WEIGHT	CODE
600x600x40	1.9 Kg	6140600
1200x600x40	3.7 Kg	6141200

Rockwool Quadrotto features

SIZE	WEIGHT	CODE
600x600x40	4.1 Kg	6140610
1200x600x40	7.2 Kg	6141210

Radiant metal Quadrotto

The metal radiant panel consists of a 5/10 post painted RAL 9016 steel ceiling with 15 mm base and 8 mm lowered right angle, microperforated surface and 20 mm smooth edge. The hydraulic circuit consisting of Ø 6 mm pipework is fixed to the ceiling via an aluminium diffuser. The panel is available with polystyrene or rockwool (fire reaction class: A1) insulation.

Sheet metal ceiling characteristics	600	1200	Unit
Material	Steel 5/10		
Smooth perimeter	20		mm
Base	15	24	mm
Rebate	8		mm

Polystyrene insulation characteristics		600	1200	Unit	Standard
Size of insulating panel		593x593	1190x593	mm	UNI EN 822
Standard thickness		40		mm	UNI EN 823
Insulation base thickness		34		mm	UNI EN 1264-3
Equivalent total thickness		37.0	37.8	mm	UNI EN 1264-3
Bending strength	BS	170		kPa	UNI EN 12089
Compressive stress at 10% deformation	CS(10)	120		kPa	UNI EN 826
Thermal conductivity 10 °C	λ_d	0.035		W/(m · K)	UNI EN 12667
Thermal resistance	Rd	1.05		(m ² · K)/W	UNI EN 12667
Thermal transmittance	U	0.95		W/(m ² · K)	
Water vapour diffusion resistance factor	μ	30 ÷ 70			UNI EN 12086
Water vapour permeability	δ	0.009 ÷ 0.020		mg/(Pa · h · m)	UNI EN 12086
Dimensional stability at 48h and 70 °C	DS(70,-)	1		%	UNI EN 1604
Long term water absorption by partial immersion	Wlp	0.5		Kg / m ²	UNI EN 12087
Long term water absorption by total immersion	WI(T)	≤3		%	UNI EN 12087
Fire reaction	Euroclass	E			EN ISO 11925-2
Limit of operating temperature		70		°C	
Declaration according to UNI EN 13163		T1-L3-W2-S2-P5-BS170-CS(10)120-DS(70,-)1-WL(T)3-MU(30-70)			

Rock wool insulation characteristics		600	1200	Unit	Standard
Size of insulating panel		600x600	1200x600	mm	UNI 822
Standard thickness		40		mm	UNI 823
Declared thermal conductivity	λ_d	0.040		W/(m · K)	UNI EN 12667, 12939
Thermal resistance	Rd	1		(m ² · K)/W	
Resistance to compression 10%	σ_{10}	70		kPa	UNI EN 826
Resistance to point load	F _p	600		N	UNI EN 12430
Tensile bond strength	σ_{mt}	15		kPa	UNI EN 1607
Water vapour diffusion resistance factor	μ	1			UNI EN 12086
Short term water absorption by partial immersion	Ws	< 1		kg/m ²	EN 1609
Long term water absorption by partial immersion	WI(p)	< 3		kg/m ²	EN 12087
Specific heat	C _p	1030		J / (KgK)	UNI EN 12524
Density	ρ	165		Kg / m ³	UNI EN 1602
Fire reaction	Euroclass	A1			UNI EN 13501-1
Declaration according to UNI EN 13162		MW-EN 13162 T5-CS(10/Y)70-PL(5)600-TR15-DS(TH)-DS(T+)-MUI-WS-WL(p)			

PE-HD-Xc pipe characteristics								
Outside diam. (mm)	Thickness (mm)	S-value	SDR-value	CLASS 4		CLASS 5	Water content (l/m)	
6	1	2.5	6	Tmax 60 °C	10 bar	Tmax 80 °C	10 bar	0,013

S = nominal pipe serial number according to ISO 4065, SDR = standard dimension ratio, allocation of SDR values, according to DIN 16893 and/or DIN EN ISO15875-2

Technical data of PE-HD-Xc pipe		Value	Unit	Standard
Degree of cross-linking	23°C	≥ 60	%	DIN 16892
Density	23°C	≈ 0,94	g/cm ³	DIN 16892/DIN 53479
Flexural impact strength accord. to Charpy	23°C	no failure	kJ/m ²	DIN EN ISO 179-1/2
Tensile strength	23°C	24 ÷ 30	N/mm ²	DIN EN ISO 6259-1
Tenacity	23°C	24 ÷ 26	N/mm ²	DIN EN ISO 6259-1
Elongation at break	23°C	400 ÷ 600	%	DIN EN ISO 6259-1
Elastic modulus	23°C	600 ÷ 800	N/mm ²	DIN 16892/DIN EN ISO 128
Stress crack resistance		no failure		ASTM D 1693
Moisture absorption		< 0,01	mg (4d)	DIN EN ISO 62
Coefficient of linear expansion	0°C – 70°C	1,5 · 10 ⁻⁴	1/K	DIN 16892 / DIN 53752
Thermal conductivity		≤ 0,41	W/(K · m)	DIN 16892 / DIN EN 12664
Smallest bend radius		≥ 5 · D	mm	DIN 4726
Oxygen tightness	40°C	≤ 0,32	mg/(m ² · d)	DIN 4726

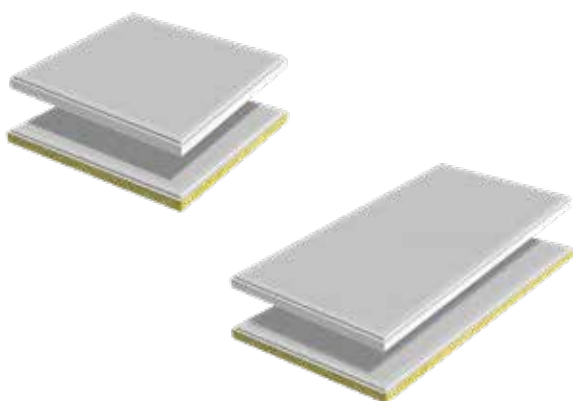

Blank metal panel

Passive panel without hydraulic circuit, consisting of a 5/10 post painted RAL 9016 steel metal ceiling with 15 mm base, microperforated surface and 20 mm smooth edge.

Available with polystyrene or rockwool (fire reaction class: A1) insulation.

Panel features

INSULATION	SIZE	WEIGHT	CODE
Polystyrene	600x600x40	1.7 Kg	6140605
Rockwool	600x600x40	4.0 Kg	6140615
Polystyrene	1200x600x40	3.6 Kg	6141205
Rockwool	1200x600x40	7.3 Kg	6141215

PRODUCTS THAT COMPOSE THE SYSTEM

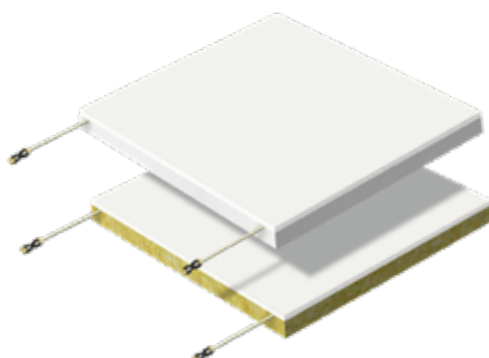

Panel features

Dimensions: 600x600x50 mm

INSULATING	WEIGHT	CODE
Polystyrene	3.7 Kg	6140500
Rockwool	5.2 Kg	6140550

Radiant plasterboard Quadrotto

The radiant plasterboard Quadrotto is composed of a smooth plasterboard sheet 9 mm thick, white RAL 9003, with high performance in terms of light reflection and absorption of acoustic reverberation. The hydraulic circuit consisting of a Ø 6 mm pipe is fixed to the panel by an aluminium diffuser. Quadrotto is available with polystyrene or rockwool (fire reaction class rock wool: A1) insulation.

Plasterboard sheet characteristics	Value	Unit
Size	600x600	mm
Standard thickness	9.5	mm
Fire reaction	A2-s1,d0	
Thermal conductivity λ	0.2108	W/(m · K)

Polystyrene insulation characteristics		Value	Unit	Standard
Size of insulating panel		593x593	mm	UNI EN 822
Standard thickness		40	mm	UNI EN 823
Insulation base thickness		34	mm	UNI EN 1264-3
Equivalent total thickness		37.0	mm	UNI EN 1264-3
Bending strength	BS	170	kPa	UNI EN 12089
Compressive stress at 10% deformation	CS(10)	120	kPa	UNI EN 826
Thermal conductivity 10 °C	λ_d	0.035	W/(m · K)	UNI EN 12667
Thermal resistance	Rd	1.05	(m ² · K)/W	UNI EN 12667
Thermal transmittance	U	0.95	W/(m ² · K)	
Water vapour diffusion resistance factor	μ	30 ÷ 70		UNI EN 12086
Water vapour permeability	δ	0.009 ÷ 0.020	mg/(Pa · h · m)	UNI EN 12086
Dimensional stability at 48h and 70 °C	DS(70,-)	1	%	UNI EN 1604
Long term water absorption by partial immersion	Wlp	0.5	Kg / m ²	UNI EN 12087
Long term water absorption by total immersion	WI(T)	≤3	%	UNI EN 12087
Fire reaction	Euroclass	E		EN ISO 11925-2
Limit of operating temperature		70	°C	
Declaration according to UNI EN 13163		T1-L3-W2-S2-P5-BS170-CS(10)I20-DS(70,-)I1-WL(T)3-MU(30-70)		

Rockwool insulation characteristics		Value	Unit	Standard
Size of insulating panel		600x600	mm	UNI 822
Standard thickness		40	mm	UNI 823
Declared thermal conductivity	λ_d	0.040	W/(m · K)	UNI EN 12667, 12939
Thermal resistance	Rd	1	(m ² · K)/W	
Resistance to compression 10%	σ_{10}	70	kPa	UNI EN 826
Resistance to point load	F _p	600	N	UNI EN 12430
Tensile bond strength	σ_{mt}	15	kPa	UNI EN 1607
Water vapour diffusion resistance factor	μ	1		UNI EN 12086
Short term water absorption by partial immersion	Ws	< 1	kg/m ²	EN 1609
Long term water absorption by partial immersion	WI(p)	< 3	kg/m ²	EN 12087
Specific heat	C _p	1030	J / (KgK)	UNI EN 12524
Density	ρ	165	Kg / m ³	UNI EN 1602
Fire reaction	Euroclass	A1		UNI EN 13501-1
Declaration according to UNI EN 13162		MW-EN 13162 T5-CS(10/Y)70-PL(5)600-TR15-DS(TH)-DS(T+)-MU1-WS-WL(p)		

PE-HD-Xc pipe characteristics								
Outside diam. (mm)	Thickness (mm)	S-value	SDR-value	CLASS 4		CLASS 5		Water content (l/m)
6	1	2.5	6	Tmax 60 °C	10 bar	Tmax 80 °C	10 bar	0,013
S = nominal pipe serial number according to ISO 4065, SDR = standard dimension ratio, allocation of SDR values, according to DIN 16893 and/or DIN EN ISO15875-2								
Technical data of PE-HD-Xc pipe			Value	Unit	Standard			
Degree of cross-linking		23°C	≥ 60	%	DIN 16892			
Density		23°C	≈ 0.94	g/cm ³	DIN 16892/DIN 53479			
Flexural impact strength accord. to Charpy		23°C	no failure	kJ/m ²	DIN EN ISO 179-1/2			
Tensile strength		23°C	24 ÷ 30	N/mm ²	DIN EN ISO 6259-1			
Tenacity		23°C	24 ÷ 26	N/mm ²	DIN EN ISO 6259-1			
Elongation at break		23°C	400 ÷ 600	%	DIN EN ISO 6259-1			
Elastic modulus		23°C	600 ÷ 800	N/mm ²	DIN 16892/DIN EN ISO 128			
Stress crack resistance			no failure		ASTM D 1693			
Moisture absorption			< 0,01	mg (4d)	DIN EN ISO 62			
Coefficient of linear expansion		0°C – 70°C	1,5 · 10 ⁻⁴	1/K	DIN 16892 / DIN 53752			
Thermal conductivity			≤ 0,41	W/(K · m)	DIN 16892 / DIN EN 12664			
Smallest bend radius			≥ 5 · D	mm	DIN 4726			
Oxygen tightness		40°C	≤ 0,32	mg/(m ² · d)	DIN 4726			

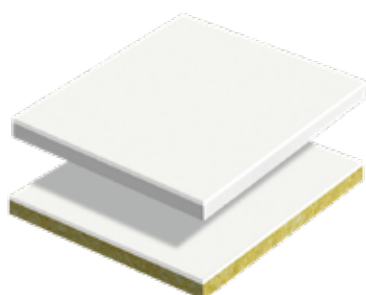

Blank plasterboard panel

Passive panel without hydraulic circuit, with smooth plasterboard sheet, 9 mm thick, white RAL 9003, with high performance in terms of light reflection and absorption of acoustic reverberation. Available with polystyrene or rockwool (fire reaction class rock wool: A1) insulation.

Panel features
Dimensions: 600x600x40 mm

INSULATION	WEIGHT	CODE
Polystyrene	3.4 Kg	6140510
Rockwool	5.0 Kg	6140560

PRODUCTS THAT COMPOSE THE SYSTEM

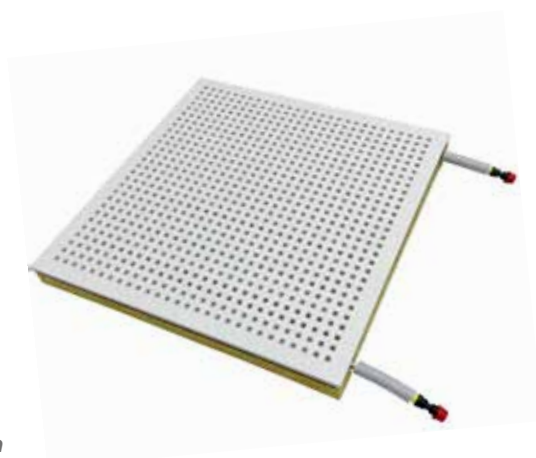

Quadrotto features

Dimensions: 600x600x40 mm

INSULATION	WEIGHT	CODE
Rockwool	4.9 Kg	6140552

Acoustic radiant plasterboard Quadrotto

Radiant panel consisting of a slab with regular square holes, thickness 10 mm, satin finish colour RAL 9010 with high performance: sound absorption ($\alpha_{\text{paw}}=0,4$) of the reverberation generated inside the room, light reflection (approx. 70%) and absorption of up to 70% of the formaldehyde in the room. Complete with hydraulic circuit consisting of \varnothing 6 mm pipe and rockwool insulation (fire reaction class: A1).

Acoustic plasterboard panel					
Characteristic	Value	Unit	Characteristic	Value	Unit
Size of insulating panel	600x600	mm	Structure	24/15	
Nominal Thickness	10	mm	Holes section	9x9	mm
Holes pitch	19,5	mm	Humidity resistance	RH 70	
Fire reaction: Euroclass A2-s1,d0 standard EN 13501-1					
Brightness (light reflection coefficient)	~70	%			

Rockwool insulation		Value	Unit	Standard
Size of insulating panel		600x600	mm	UNI 822
Standard thickness		40	mm	UNI 823
Declared thermal conductivity	λ_d	0,040	W/(m · K)	UNI EN 12667, 12939
Thermal resistance	Rd	1	(m ² · K)/W	
Compressive stress at 10% deformation	σ_{10}	70	kPa	UNI EN 826
Resistance to point load	Φ_p	600	N	UNI EN 12430
Tensile bond strength	σ_{mt}	15	kPa	UNI EN 1607
Water vapour diffusion resistance factor	μ	1		UNI EN 12086
Short term water absorption by partial immersion	Ws	<1	kg/m ²	EN 1609
Long term water absorption by partial immersion	WI(p)	<3	kg/m ²	EN 12087
Specific heat	CP	1030	J / (KgK)	UNI EN 10456
Density	ρ	165	Kg / m ³	UNI EN 1602
Fire reaction	Euroclass	A1		UNI EN 13501-1
Declaration according to UNI EN 13162	MW-EN 13162 T5-CS(10/Y)70-PL(5)600-TR15-DS(TH)-DS(T+)-MUI-WS-WL(p)			

PE-HD-Xc pipe characteristics

Outside diam. (mm)	Thickness (mm)	S-value	SDR-value	CLASS 4		CLASS 5		Water content (l/m)
6	1	2.5	6	Tmax 60 °C	10 bar	Tmax 80 °C	10 bar	0,013

S = nominal pipe serial number according to ISO 4065, SDR = standard dimension ratio, allocation of SDR values, according to DIN 16893 and/or DIN EN ISO15875-2

Technical data of PE-HD-Xc pipe		Value	U.M.	Standard
Degree of cross-linking	23 °C	≥ 60	%	DIN 16892
Density	23 °C	≈ 0,94	g/cm ³	DIN 16892/DIN 53479
Flexural impact strength accord. to Charpy	23 °C	no failure	kJ/m ²	DIN EN ISO 179-1/2
Stress crack resistance		no failure		ASTM D 1693
Moisture absorption		< 0,01	mg (4d)	DIN EN ISO 62
Coefficient of linear expansion	0 °C – 70 °C	1,5 · 10 ⁻⁴	1/K	DIN 16892 / DIN 53752
Thermal conductivity		≤ 0,41	W/(K · m)	DIN 16892 / DIN EN 12664
Oxygen tightness	40 °C	≤ 0,32	mg/(m ² · d)	DIN 4726

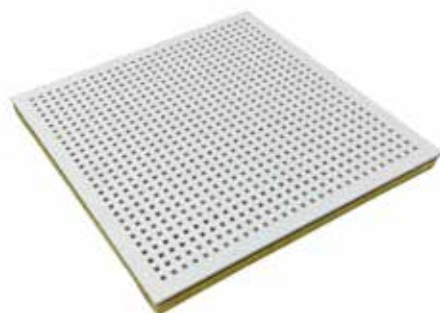

Acoustic blank plasterboard panel

Passive panel without hydraulic circuit, with regular square perforated plasterboard sheet, 10 mm thick, white RAL 9010, with high performance in terms of acoustic reverberation absorption (Alphaw=0,8), light reflection and absorption of up to 70% of formaldehyde in the room.

Rockwool insulation (fire reaction class rock wool: A1).

Quadrotto features

Dimensions: 600x600x40 mm

INSULATION	WEIGHT	CODE
Rockwool	4.7 Kg	6140562



Pre-insulated pipe Ø 20 mm

PB pipe with oxygen barrier according to DIN 4726 EN 12319-2, Ø 20 mm, pipe insulation made of expanded polyethylene, thickness 6 mm. Reaction to fire class: BL-s2, d0. It is used to connect distributors with b!klimax manifolds.

TYPE	SIZE	CODE
red roll 50 m	Ø 20 mm	6200020
blu roll 50 m	Ø 20 mm	6201020
red 1 bar 4 m	Ø 20 mm	6202020
blu 1 bar 4 m	Ø 20 mm	6203020

Note:
for further technical data see page 72

8-way Distributors



Pair of distributors made of plastic, specially shaped to guarantee easy connection with the pipes coming from b!klimax panels. These distributors are provided with anticondensation shells made of polystyrene or expanded polyethylene BL-s1, d0, push-fit pipe fittings for pipes Ø 6 mm and Ø 20 mm, and closing plastic bands.

MODEL	INSULATION	CODE
8-way open	polystyrene	6210040
8-way open	polyethylene	6210041
8-way terminal	polystyrene	6210050
8-way terminal	polyethylene	6210051

4-way Distributors



Pair of distributors made of plastic, specially shaped to guarantee easy connection with the pipes coming from b!klimax panels. These distributors are provided with anticondensation shells made of polystyrene or expanded polyethylene BL-s1, d0, push-fit pipe fittings for pipes Ø 6 mm and Ø 20 mm, and closing plastic bands.

MODEL	INSULATION	CODE
4-way open	polystyrene	6210060
4-way open	polyethylene	6210061
4-way terminal	polystyrene	6210070
4-way terminal	polyethylene	6210071

Straight Push-fit Fitting Ø 6 mm



Straight push-fit fitting used as connection for polybutylene pipes Ø 6 mm. It's provided with anticondensation insulation shells available in polystyrene or polyethylene BL-s1, d0.

SIZE	INSULATION	CODE
Ø 6 mm	polystyrene	6510006
Ø 6 mm	polyethylene	6510016
Ø 20 mm	polyethylene	6510026

TEE Push-fit Fitting 20-20-20 mm



TEE push-fit fitting used as connection for PB pipes Ø 20 mm. It's provided with anticondensation insulation shells available in polystyrene or polyethylene BL-s1, d0.

SIZE	INSULATION	CODE
Ø 20 mm	polystyrene	6510055
Ø 20 mm	polyethylene	6510056

Cross Push-fit Fitting 20-20-20-20 mm



This cross push-fit fitting is used as connection for polybutylene pipes Ø 20 mm. It's provided with anticondensation insulation shells available in polystyrene or polyethylene BL-s1, d0.

SIZE	INSULATION	CODE
Ø 20 mm	polystyrene	6510065
Ø 20 mm	polyethylene	6510066

Elbow Push-fit Fitting 20-20 mm



This ELBOW push-fit fitting is used as 90° shifting for polybutylene pipes Ø 20 mm. It's provided with polyethylene BL-s1, d0 insulation or without it.

SIZE	INSULATION	CODE
Ø 20 mm	- -	6510075
Ø 20 mm	polyethylene	6510076

PRODUCTS THAT COMPOSE THE SYSTEM



Pre-insulated PB Pipe Ø 6 mm

PB pipe Ø 6 mm with oxygen barrier according to DIN 4726 EN 12319-2, pipe insulation made of expanded polyethylene, reaction to fire class BL-s1,d0, thickness 6 mm. It is used to connect b!klimax+ and Quadroto panels to the distributors.

SIZE	CODE
Ø 6 mm	6210006

Note:
for further technical data see page 73



Lubricant for Push-fit Pipe Fittings

This lubricant is used to guarantee better insertion of the pipes into the fittings and better preservation of O-rings. (1 package every 75 circuits).

SIZE	CODE
20 ml	6603000



Closing Plugs for Outlets Ø 6 and 20 mm

Plastic plugs are used to close the unused outlets in a distributor.

SIZE	CODE
Ø 6 mm	6510040
Ø 20 mm	6510050



Industry System Elbow

Elbow for 90° shifting with pipes Ø 20 mm.

SIZE	CODE
Ø 20 mm	1140025



Spare parts kit

Replacement kit for b!klimax fittings and distributors including all the components needed to restore a pipe connection.

SIZE	CODE
for Ø 6 mm pipe	6510070
for Ø 20 mm pipe	6510080

■ THERMAL OUTPUT OF THE SYSTEM WITH METAL QUADROTTI

Thermal output in heating - ceiling

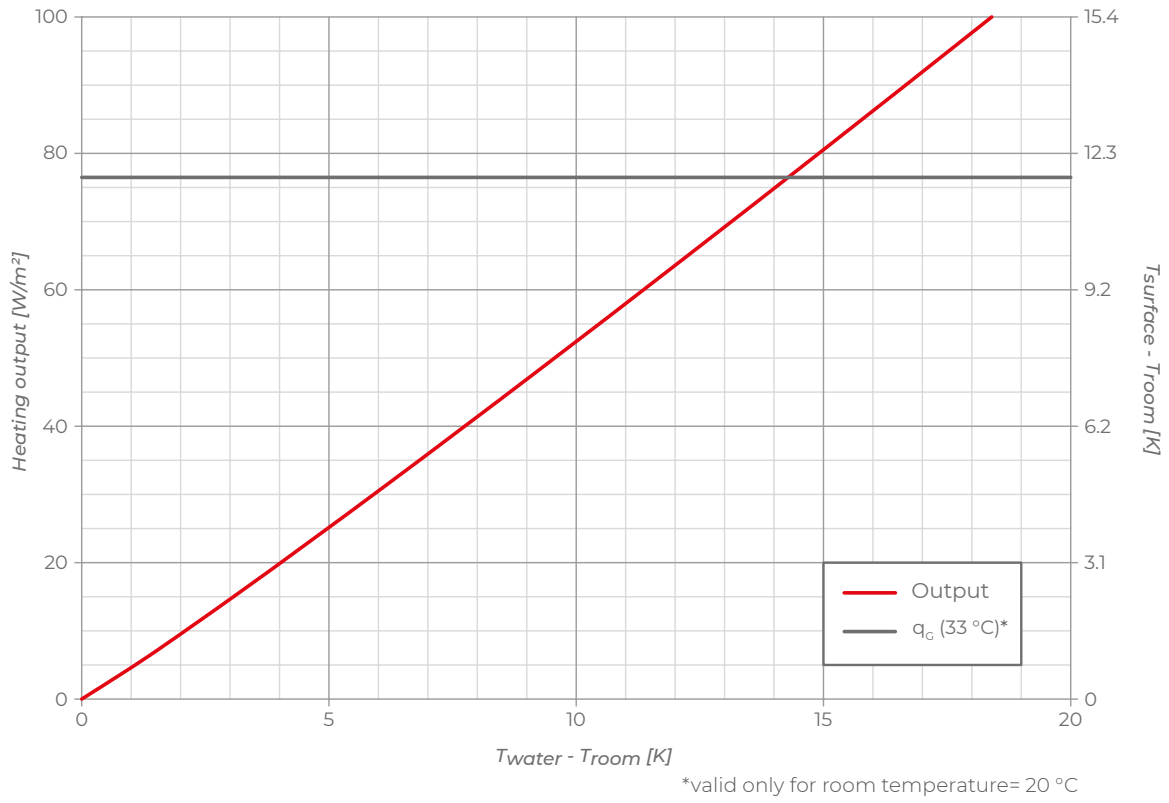

Thermal output in cooling - ceiling

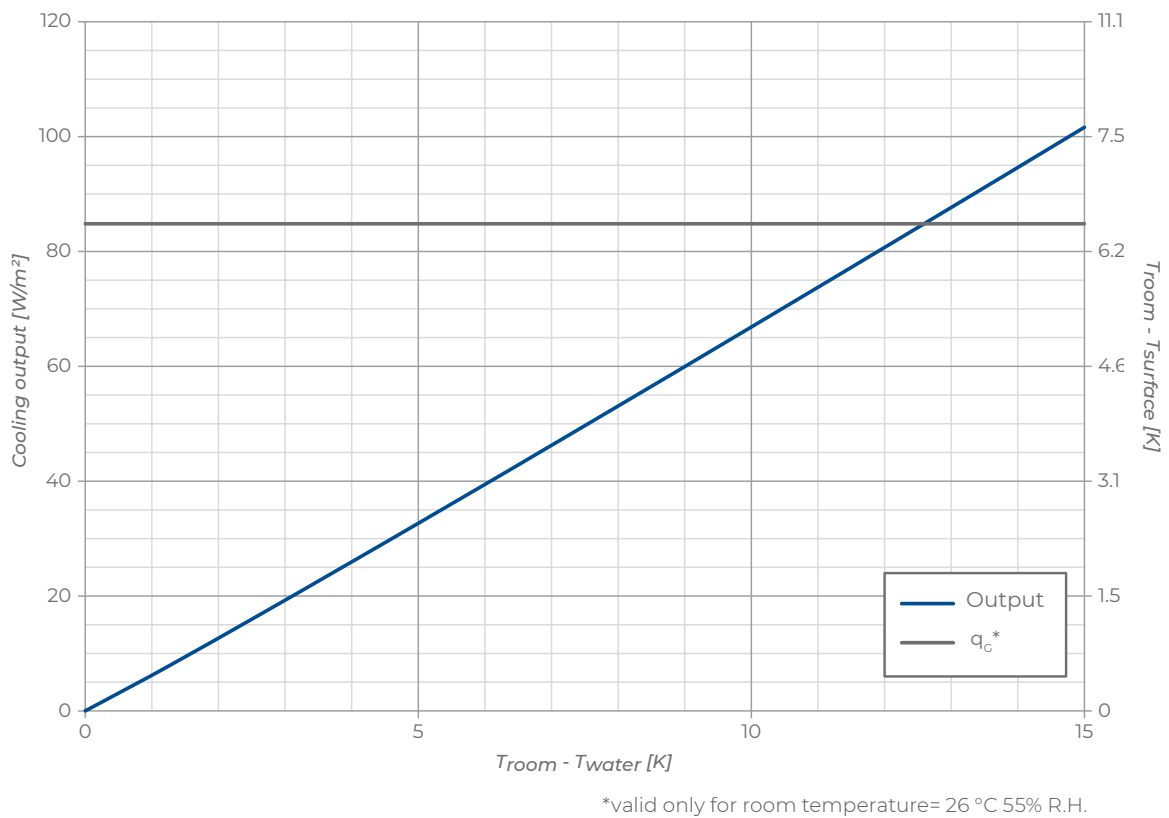

■ THERMAL OUTPUT OF THE SYSTEM WITH STANDARD PLASTERBOARD QUADROTTI AND ACOUSTIC PLASTERBOARD QUADROTTI

Thermal output in heating - ceiling

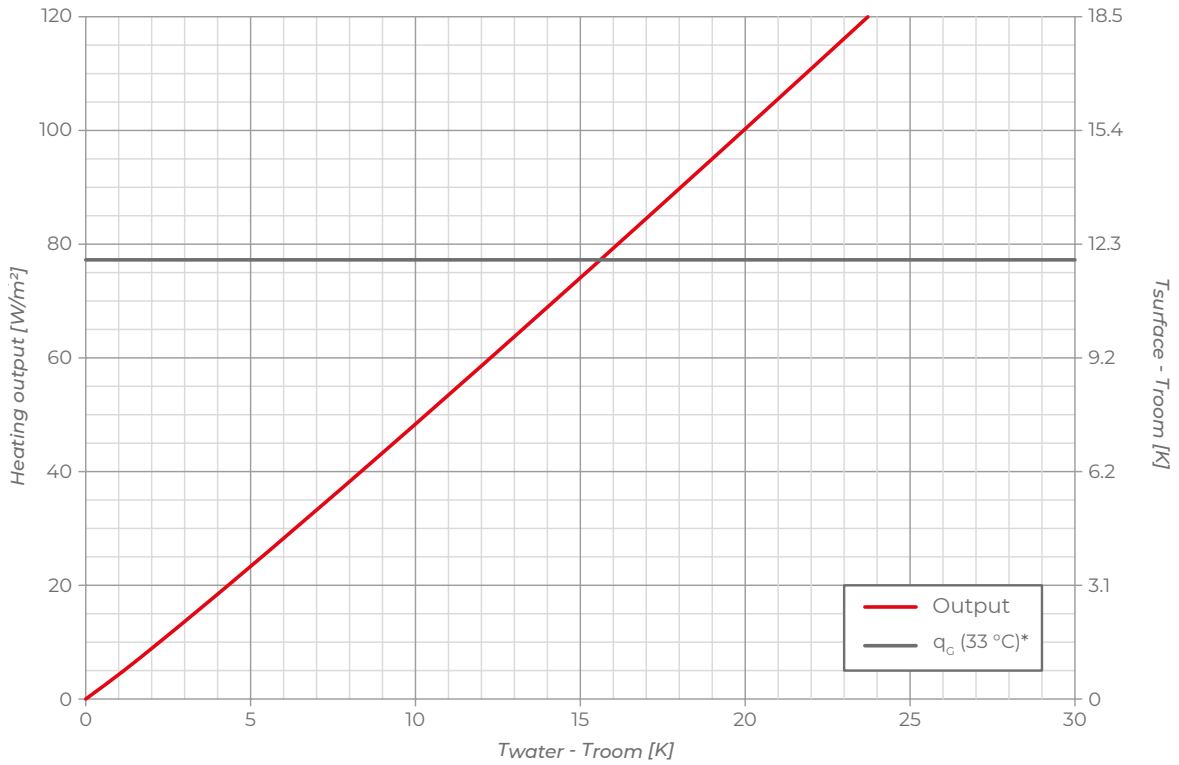

*valid only for room temperature= 20 °C

Thermal output in cooling - ceiling

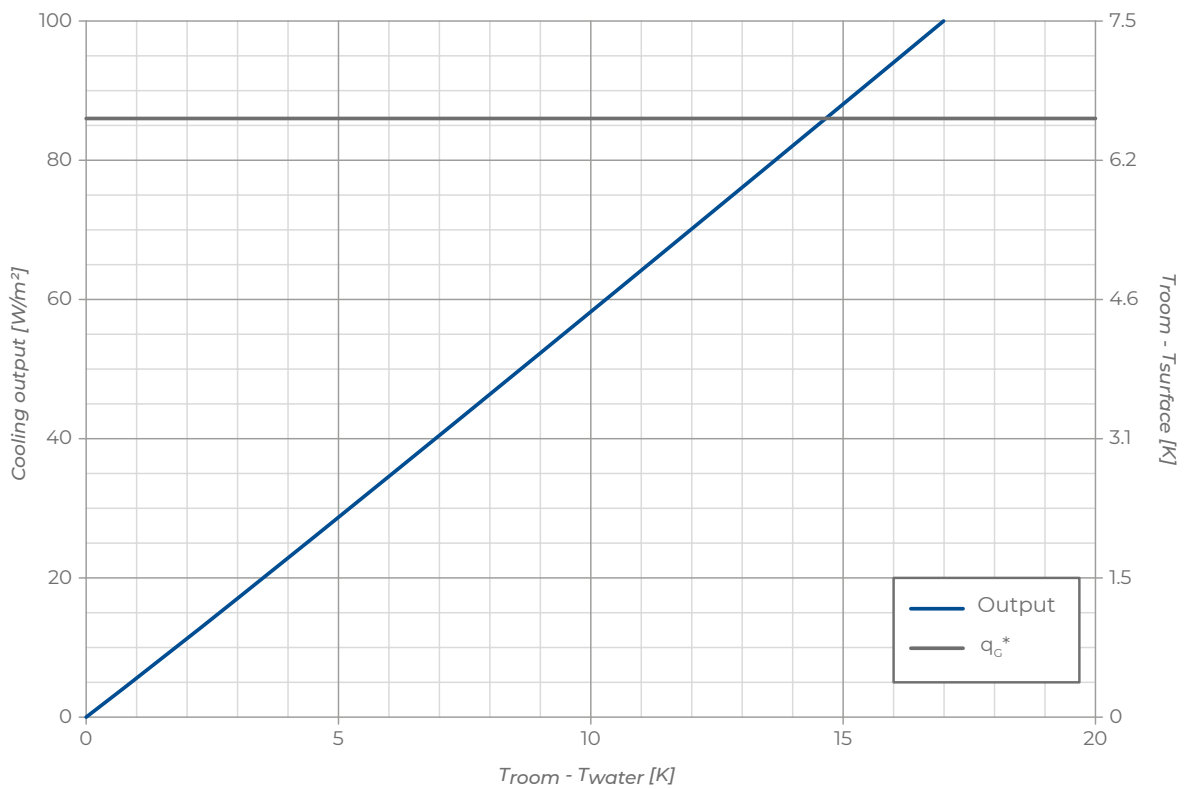

*valid only for room temperature= 26 °C 55% R.H.

**Ceiling and wall
radiant systems**

Complements





b!klimax Cabinet

This cabinet made of zinc-plated sheet iron is used to contain b!klimax manifolds. There are suitable outlets for pipes both upwards and downwards. The cabinet is equipped with a protective cover for plaster, a white metal door painted with epoxy powders, and lockset.

Model	A [cm]	B [cm]	C [cm]	Code
60	76	60	14	6431060
80	76	80	14	6431080
100	76	100	14	6431100

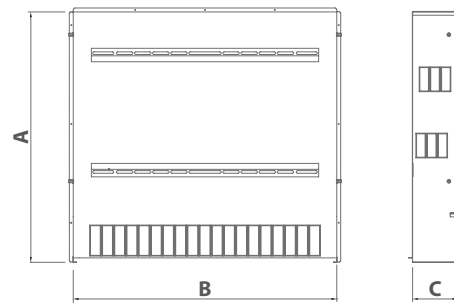

b!klimax Manifolds

The b!klimax manifold with female connection $\varnothing 1 \frac{1}{4}$ " is made of plastic material and has been designed for high flow-rate. It is equipped with shut-off valves suitable for electro-thermal heads, air vent and discharge valves, thermometers on supply and return flow, fixing brackets, Y filter and push-fit fittings with key for pipes $\varnothing 20$ mm. The b!klimax manifold can be installed horizontally or vertically with the pipes upwards or downwards. Anti-condensation shells are supplied as standard.

Performance and dimensions	Value
Liquid	water / glycolic water 50% at most
Normal operation pressure	0÷6 bar
Max. testing pressure	10 bar
Burst pressure	> 22 bar with room temperature / > 15 bar with 50 °C
Normal operation temperature	5÷55 °C
Max. temperature	90 °C a 3 bar
Main outlet of the manifold	1" 1/4 F Turning brass thread for the connection with circulation pump
Derivations	Pipe connection $\varnothing 20$ mm through push fit fitting with key sliding Distance between axis: 46.5 mm

Dimensions of the manifold												
Code		6302102	6302103	6302104	6302105	6302106	6302107	6302108	6302109	6302110	6302111	6302112
No. outlets		2+2	3+3	4+4	5+5	6+6	7+7	8+8	9+9	10+10	11+11	12+12
Manifold width	cm.	32	36	41	46	50	55	60	64	69	73	78

RDZ Electrothermic Head



The thermo-electric actuator performs the shut-off function on each circuit with control by the room thermostat. It can be installed in any position, even upside-down. The function display of the actuator allows identifying the operating condition (open/closed). Easy slot assembly thanks to the adapter (supplied as standard). Voltage: 230V with or without micro-switch or 24V with micro-switch. Protection class: IP54 (all assembly positions). It can be used with b!klimax, TOP COMPOSIT, CONTROL and High-Temperature outlets for KITS.

VOLTAGE	CODE
230 V	1057230
230 V w/micro	1057240
24 V w/micro	1057250

Head characteristics	230 V	24 V
Operating voltage	230 V AC, +10%...-10%, 50/60 Hz	24 V AC/DC, +20%...-10%
Max. inrush current	< 550 mA during max. 100 ms	< 300 mA during max. 2 ms
Operating power	1 W *	1 W *
Stroke (actuator travel)	4.0 mm	4.0 mm
Actuating force	100 N ±5%	100 N ±5%
Fluid temperature	0 to +100°C **	0 to +100°C **
Storage temperature	-25°C to +60°C	-25°C to +60°C
Ambient temperature	0 to +60°C	0 °C to +60 °C
Type of protection / Class of protection	IP 54 *** / II	IP 54 (EN 60529) / II
CE conformity according to	EN 60730	EN 60730
Casing	Polyamide, colour: light grey (RAL 7035)	Polyamide, colour: light grey (RAL 7035)
Connection line	type: 2 x 0.75 mm ² PVC, colour: light gray (RAL 7035), length: 1 m	type: 4 x 0.75 mm ² PVC, colour: light gray (RAL 7035), length: 1 m
Weight with connecting cable (1 m)	100 g	(1 m): approx. 150 g
Surge protection according to EN 60730-1	min. 2.5 kV	

* measured with precision reference instrument LMG95 ** or higher, depending on the adapter length *** in all installation positions

Electrical connection

Electrothermic head 24 V with micro

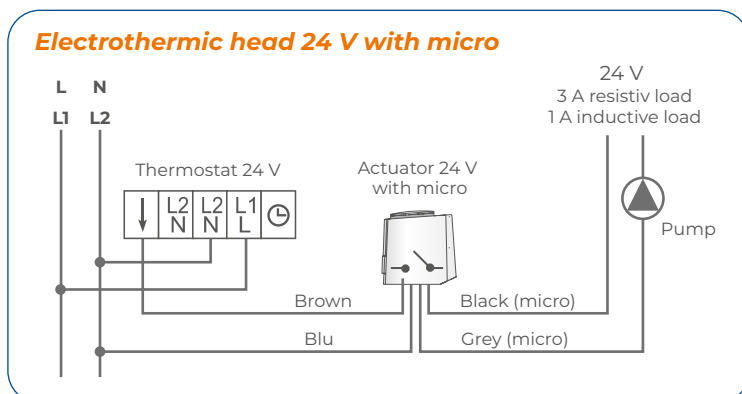

Electrical connection

Electrothermic head 230 V

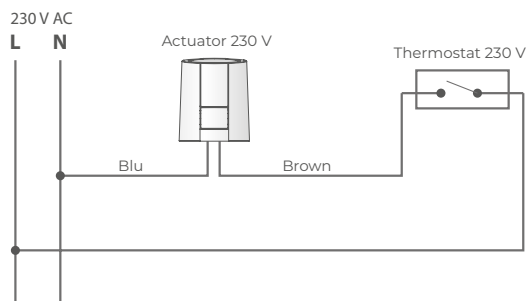

Electrothermic head 230 V with micro

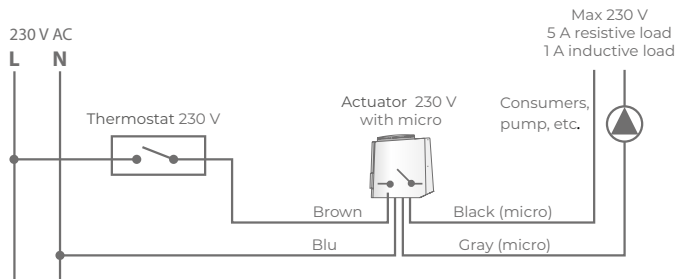

Air Trap

The air separator is made of brass, and it is used to collect the air that accumulates in the hydraulic circuit so that it can be eliminated. It is a necessary component in b!klimax and b!klimax+ systems, but it is recommended also in the other systems. FF (female - female) pipe connections.

With horizontal connections

FLOW RATE	SURFACE	SIZE	CODE
1.9 m ³ /h	up to 60 m ²	Ø 3/4"	6440020
2.6 m ³ /h	up to 85 m ²	Ø 1"	6440025
5.3 m ³ /h	up to 175 m ²	Ø 1 1/4"	6440032
6.3 m ³ /h	up to 210 m ²	Ø 1 1/2"	6440040
9.0 m ³ /h	up to 300 m ²	Ø 2"	6440050

With vertical connections

FLOW RATE	SURFACE	SIZE	CODE
1.9 m ³ /h	up to 60 m ²	Ø 3/4"	6440021
2.6 m ³ /h	up to 85 m ²	Ø 1"	6440026

Operating principle

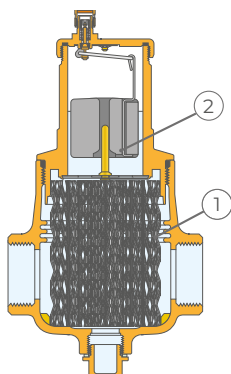

The air separator uses the combined action of several physical principles. The active part consists of an assembly of concentric metal mesh surfaces (1). These elements create the whirling movement required to facilitate the release of micro-bubbles and their adhesion to these surfaces. The bubbles, fusing with each other, increase in volume until the hydrostatic thrust is such as to overcome the adhesion force to the structure. They rise towards the top of the unit from which they are released through a float-operated automatic air release valve (2). It is designed in such a way that the direction of the fluid flow makes no difference.

Pre-insulated Ø 20 mm pipe

PB pipe with oxygen barrier according to DIN 4726 EN 12319-2, Ø 20 mm, pipe insulation made of expanded polyethylene, thickness 6 mm. Reaction to fire class: BL-s2,d0. It is used to connect distributors with b!klimax manifolds.



DIAMETER	COLOR	PACKAGE	CODE
20 mm	red	roll 50 m	6200020
20 mm	blu	roll 50 m	6201020
20 mm	red	1 bar 4 m	6202020
20 mm	blu	1 bar 4 m	6203020

Application field	CLASS 4	For use with hot and cold water (Tmax 60 °C)
	CLASS 5	For use with hot and cold water (Tmax 80 °C)

Outside diam. (mm)	Thickness (mm)	Weight (g/m)	CLASS 4 (bar)	CLASS 5 (bar)	Water content (l/m)
20	2	120	8	8	0,201

Pipe characteristics	Value	Unit	Standard
Standard			DIN 16968
Oxygen tightness	≤ 0.32	mg O ₂ / (m ² · d)	DIN 4726
Degree of cross-linking	≥ 70	%	
Density	0.920	g/cm ³	ISO 1183
Thermal expansion coefficient at 20 °C	1.3 · 10 ⁻⁴	m/(m·K)	
Thermal conductivity	0.22	W/(m·K)	
Softening temperature	> 130	°C	
Elongation at break a 20 °C	> 300	%	ISO 8986-1
Ultimate Tensile Stress at 20 °C	19	MPa	ISO 8986-2
Roughness factor	0.0005		

Pipe insulation characteristics	Value	Unit	Standard
Thickness	6	mm	
Density	0.03 ÷ 0.05	g/cm ³	ISO 1183
Temperature range	-45 / +95	°C	
Thermal conductivity at 40 °C	0.039	W/(m·K)	
Thermal conductivity at 0 °C	0.033	W/(m·K)	
Water vapour permeability	> 5000		
Reaction to fire (Euroclass)	BL-s1, d0		EN 13501-1



Pipe insulation for 6mm pipe

PB Ø 6 mm pipewith oxygen barrier according to DIN 4726 EN 12319-2, pipe insulation made of expanded polyethylene, reaction to fire class BL -s1, d0, thickness 6 mm. It is used to connect blklimax+ and Quadrotto panels to the distributors.

DIAMETER	CODE
6 mm	6210006

Application field	CLASS 4	For use with hot and cold water (Tmax 60 °C)
	CLASS 5	For use with hot and cold water (Tmax 80 °C)

Outside diam. (mm)	Thickness (mm)	Weight (g/m)	CLASS 4 (bar)	CLASS 5 (bar)	Water content (l/m)
6	1	15.4	10	10	0,013

Pipe characteristics	Value	Unit	Standard
Standard			DIN 16968
Oxygen tightness	≤ 0.32	mg O ₂ / (m ² · d)	DIN 4726
Degree of cross-linking	≥ 70	%	
Density	0.920	g/cm ³	ISO 1183
Thermal expansion coefficient at 20 °C	1.3 · 10 ⁻⁴	m/(m·K)	
Thermal conductivity	0.22	W/(m·K)	
Softening temperature	> 130	°C	
Elongation at break a 20 °C	> 300	%	ISO 8986-1
Ultimate Tensile Stress at 20 °C	19	MPa	ISO 8986-2
Roughness factor	0.0005		

Pre-insulated PB Pipe

Closed-cell elastomeric foam insulating sleeve, smooth on the surface, for thermal insulation of PB Ø 6 mm pipe. Thickness 6 mm.



DIAMETER	CODE
6 mm	6320010

Pipe insulation characteristics	Value	Unit	Standard
Thickness	6	mm	
Density	0.03 ÷ 0.05	g/cm ³	ISO 1183
Temperature range	-45 / +95	°C	
Thermal conductivity at 40 °C	0.039	W/(m·K)	
Thermal conductivity at 0 °C	0.033	W/(m·K)	
Water vapour permeability	> 5000		
Reaction to fire (Euroclass)	BL-s1, d0		EN 13501-1



PE-RT Ø 8 pipe

PE-RT Ø 8 mm pipe with oxygen barrier according to DIN 4726 DIN EN ISO 21003-2, thickness 1 mm. It is used to connect b!klimax+ Copper 8 and Quadrotto HP tiles with the distributors.

DIAMETER	CODE
8 mm	6210018

PE-RT pipe characteristics				
Application field	CLASS 4	For use with hot and cold water	T _{max} 70 °C	Pressure 8 bar
	CLASS 5	For use with hot and cold water	T _{max} 90 °C	Pressure 6 bar
Outside diam. (mm)	Thickness (mm)		Weight (g/m)	Water content (l/m)
8	1		22	0.028



Insulation for PE-RT pipe

Insulation for PE-RT Ø 8 mm pipe made of expanded polyethylene, thickness 6 mm. Reaction to fire class: BL -s1, d0.

DIAMETER	CODE
8 mm	6320008



Biocida XR40

This sanitiser provides protection for surface heating and cooling systems against bacterial and fungal contamination. Such contamination can cause blockages in some parts of the installation, for example in the pipes, manifolds, valves or heat exchanger. Non-corrosive substance, easy and quick to dose. Biocida XR40 is compatible with Inhibitor XR20, and they shall be both used at first fill of the radiant system in the primary circuit.

SIZE	CODE
3 liters	1091301

Dosage	Application instructions
BIOCIDA XR40 should be dosed at 1% of the water volume, i.e. 1 litre per 100 litres of water contained in the system. The 3-litre pack satisfies a typical civil heating system: 80-140 m ² house, underfloor heating and/or radiators.	For an empty system introduce the product at any point of it before loading water. For a full system, use a dosing device to inject BIOCIDE XR40 in any access point of the system. Permanent treatment: leave in the system.



Inibitor XR20

The inhibiting treatment provides protection for heating systems against corrosion. It can be used in installations with aluminium components, and it is suitable for any kind of installation.

SIZE	CODE
3 liters	1091105
10 liters	1091111

Dosage	Application instructions
<p>INIBITOR XR20 should be dosed at 2% of the water volume, i.e. 2 litres per 100 litres of water contained in the system. The 3-litre pack satisfies a typical civil heating system: 15- 25 kW boiler, 80-140 m² house, floor heating system and/or radiators. For larger systems, 10 litre packs can be used. An excess of product does not cause any issues.</p>	<p>For an empty system, introduce the product at any point in the system before filling with water. For a full system, use a dosing device to inject INIBITOR XR20 in any access point of the system.</p> <p>Permanent treatment: leave in the system.</p>



***Underfloor radiant
systems
with low thermal
inertia***





Innovation, with high performance

Underfloor heating systems with low thermal inertia are characterised by their ability to respond quickly to the climatic demands of the room in which they are installed, as the floor quickly reaches the desired temperature. Thus it is possible to always obtain the right indoor comfort and optimise energy consumption.

This particular characteristic makes low thermal inertia systems an ideal solution for any type of building and in particular for contemporary ones characterised by airtight envelopes and low thermal requirements.

Thanks to their very low thickness, they are also ideal for building renovations where the floor space available for the system is limited.

Available in a wide range of thicknesses, weights and materials, they can meet a variety of design and installation needs, reduce running costs and provide a pleasant, healthy and quiet climate all year round.

THE ADVANTAGES OF UNDERFLOOR SYSTEMS WITH LOW THERMAL INERTIA:



***IDEAL FOR RENOVATIONS AND
CONTEMPORARY BUILDINGS***



***SMALL FOOTPRINT AND
LOW WEIGHT***



***LOW THERMAL
THERMAL***



***HEATING AND COOLING
IN A SINGLE SOLUTION***



***COMFORT AND
ENERGY SAVING***

■ HIGH PERFORMANCE AND FAST RESPONSE FOR ALL BUILDINGS

Low-thickness systems for new buildings

In modern buildings characterised by hermetically sealed and insulated envelopes, it is increasingly important to use systems with high thermal responsiveness, which are able to follow the sudden changes in the internal thermal load, adapting the temperature of the rooms to the need for comfort.

In the case of buildings characterised by large glass surfaces, for example, it can happen that in mid-season, when the sun is not yet high above the horizon, there is a high heat input that causes a sudden increase in the indoor temperature. The same increase could also be generated in the presence of significant internal endogenous loads. In these cases, the high inertia system, if poorly managed, would not be able to satisfy the thermal load (solar+endogenous) thus bringing the rooms to temperatures higher than the comfort limit.

The ideal, in these cases, is to have a system that is able in a few minutes to adapt its parameters to the variation of the thermal load, constantly guaranteeing the best conditions of comfort in the rooms.

The graphs below show the speed at which the systems start up and shut down, highlighting the different reactivity of traditional and low thermal inertia systems.

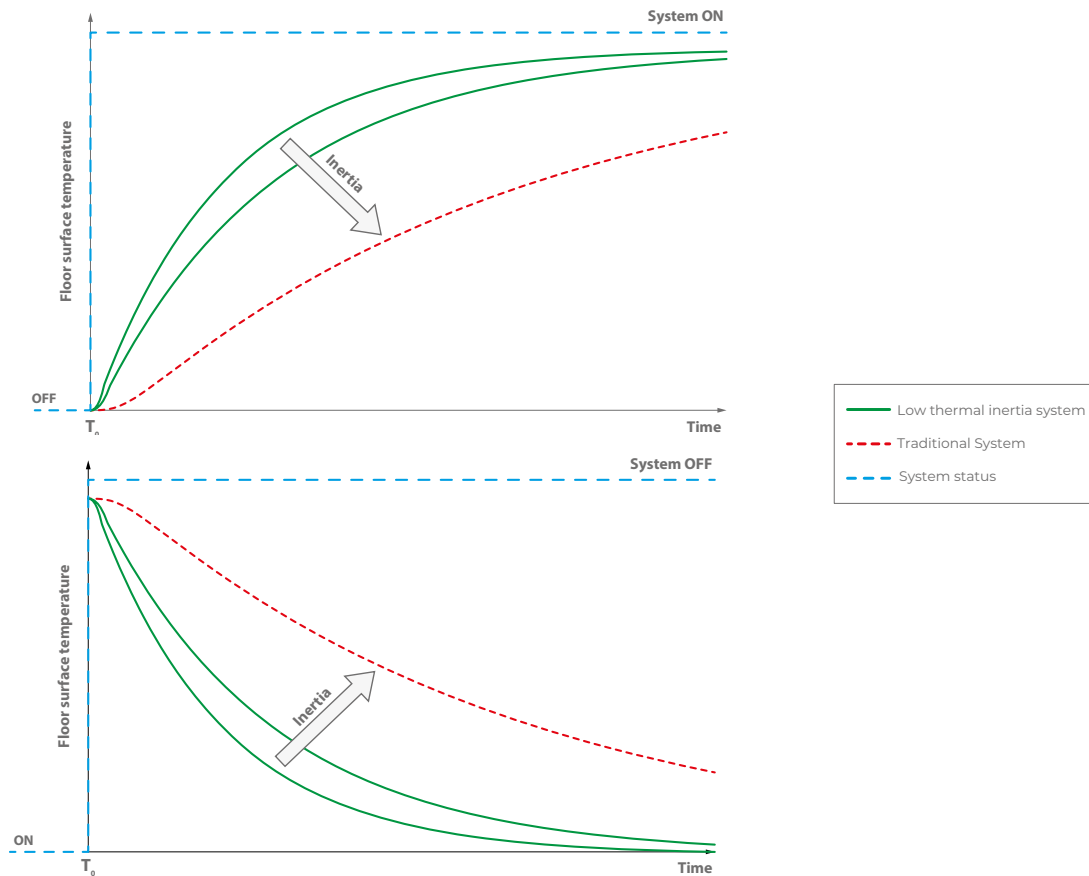

Low-thickness systems for renovations





In buildings subject to renovation or extraordinary maintenance, the radiant floor system with reduced thickness and low thermal inertia is the ideal solution.

Often, in fact, interventions on existing buildings, lead to encounter situations that hinder the installation of panels for traditional radiant underfloor systems, such as in the case of:

- buildings in which there are not the necessary heights for the installation of standard systems (the latter generally require from 7.5 to 13 cm excluding flooring)
- very old houses with subfloor that are not dimensioned to support the weight of a standard system (about 120 kg/m²)

In these circumstances, the low inertia and reduced thickness systems, thanks to their small footprint and reduced weight, make it possible to benefit of all the advantages offered by a floor system, even in contexts characterised by considerable structural constraints.

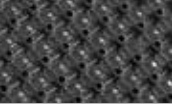
SYSTEM SELECTION BY THICKNESS

Concrete systems		Panel thickness [mm]	Pipe [mm]	Base [mm]	Stud [mm]	Concrete [mm]	Total [mm]
Super D17 page 80		15	PE-Xa Ø 17	15	19	10	44
		34	PE-Xa Ø 17	34	19	10	63
Super D page 86		10	PB Ø 12	10	16	10	36
		20	PB Ø 12	20	16	10	46
		30	PB Ø 12	30	16	10	56
		40	PB Ø 12	40	16	10	66
Quota Zero AD page 92		18	PB Ø 12	0	18.5	5	24
Dry systems		Panel thickness [mm]	Pipe [mm]	Total thickness [mm]		Allocator of load [mm]	Total [mm]
e-Dry Tech page 98		25	Multilayer Ø 16	25		4	29
e-Dry Evo page 104		25	Multilayer Ø 16	25		9	34

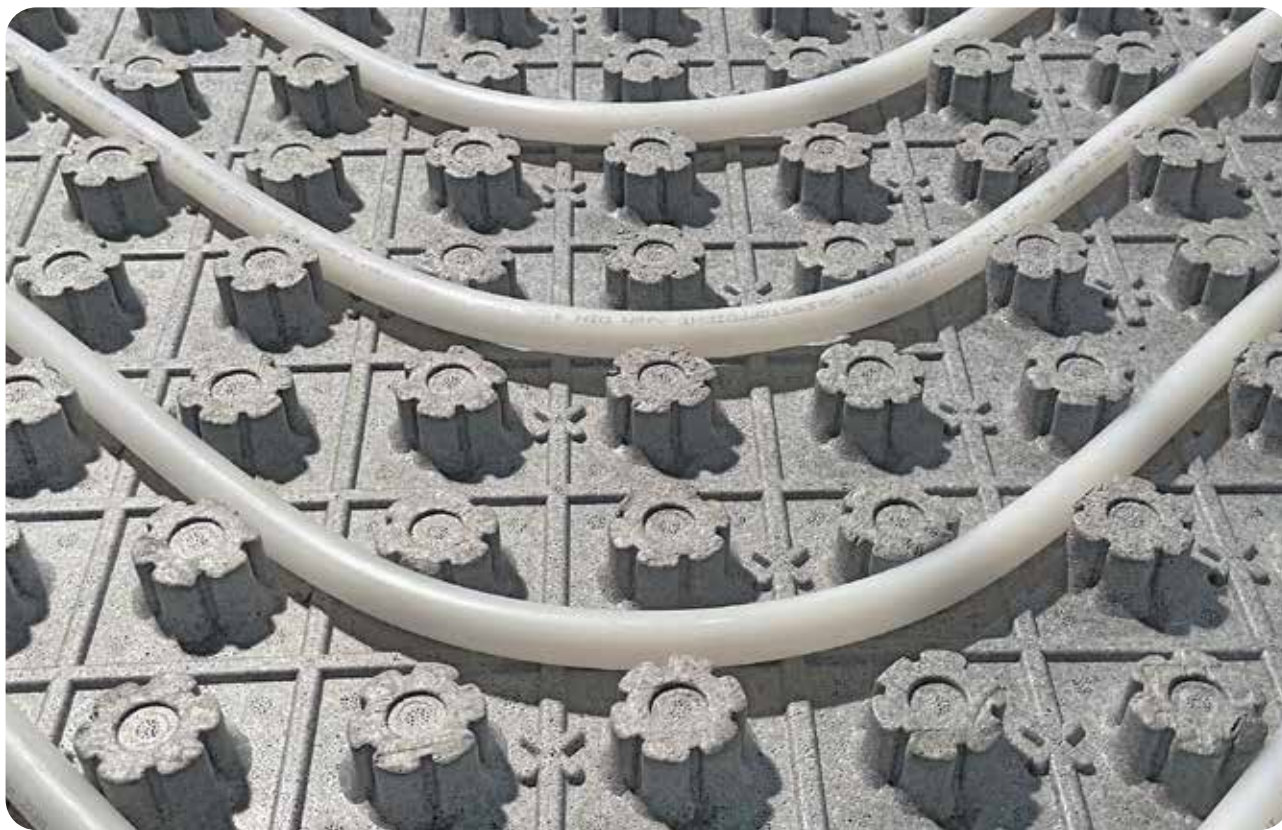

Super D17 is an underfloor heating and cooling system with low thermal inertia and reduced thickness, characterised by \varnothing 17 mm PE-Xa pipe anchored to an insulated base and embedded in the special lowered screed.

Thanks to its small dimensions, it is ideal for building renovations where the space available for the installation is limited. The low thermal inertia also makes it particularly suitable for contemporary buildings which, being low energy users, require rapid responsiveness to varying of thermal loads.

The central element of the system is the Super D17 studded panel made of sintered expanded polystyrene with graphite, in compliance with UNI EN 13163 and characterised by very high mechanical resistance. Designed to be glued to the substrate using a special polyurethane adhesive, it can also be placed on top of existing flooring, avoiding its demolition.

Available in thicknesses of 15 and 34 mm, thanks to the use of 17 mm diameter pipe, it allows a reduced number of radiant circuits and enables large areas to be served with a single manifold.

The system is completed by RDZ Tech PE-Xa pipe \varnothing 17 mm in cross-linked high-density polyethylene, equipped with anti-oxygen barrier according to DIN 4726, the open support elbows, the manifold, the Slim 9 perimetric belt and the adhesive Isocoll 160 for gluing the panel to the laying surface.

FEATURES

- Low thickness and low thermal inertia system
- PE-Xa \varnothing 17 mm pipe
- Possibility of gluing the panel to the existing flooring
- Ideal for renovations and contemporary buildings



SECTION AND DIMENSIONS

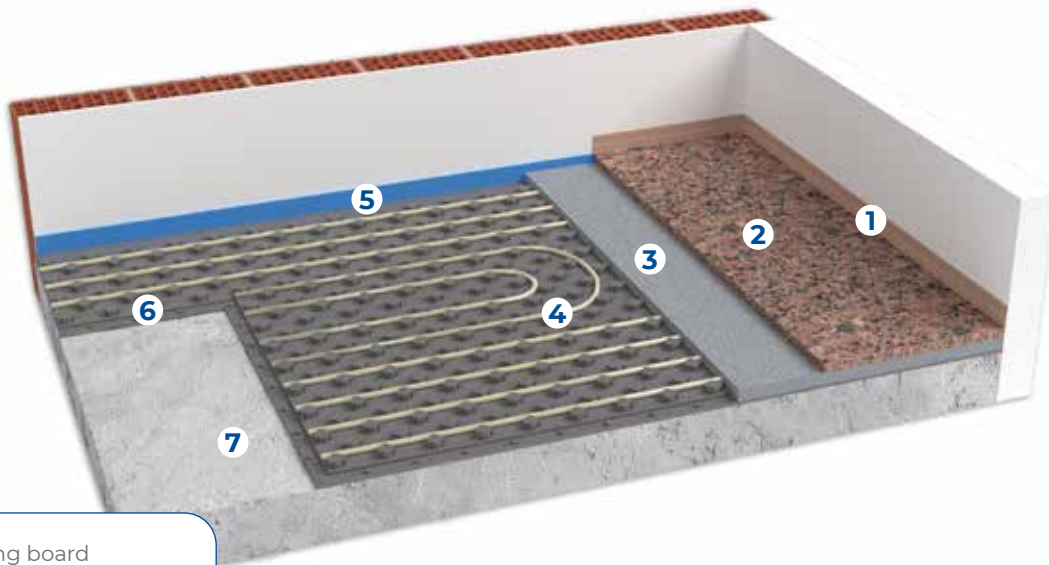

- 1 Skirting board
- 2 Flooring
- 3 Concrete
- 4 PE-Xa pipe \varnothing 17 mm
- 5 Perimeter belt
- 6 Super D17 glued panel
- 7 Stable, solid and planar subfloor



Weight of the system calculated with 10 mm level on top of the studs

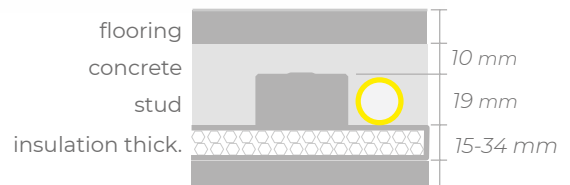

Indicative quotas

Panel thickness	15 mm	34 mm
Quote with Tiles - Parquet flooring	5.4 - 6.4 cm	7.3 - 8.3 cm
Quote with Marble - Blockboard flooring	6.4 - 8.4 cm	8.3 - 10.3 cm

Suggested Screeds

PRODUCER	SPECIAL LEVELLING SCREED
KNAUF	NE 425
KNAUF	NE 499
LECA	PaRis SLIM

Note: please refer to the Super D17 installation manual and the data sheets of the suggested products.

Installation notes

- If the floor is in direct contact with the ground (i.e. without a sanitary void or insulating sheathing), provide adequate waterproofing and subsequent levelling concrete
- Check the suitability of the substrate: flatness, surface suitable for gluing
- Check the available heights (minimum thickness of screed: 10 mm above the studs)
- Proceed with the installation of the perimeter belt
- After carefully cleaning the substrate by removing dust and residues, glue the panels with the appropriate adhesive
- Complete the system by laying the pipe as stated in the project
- Test the system and leave it under pressure until all subsequent installation and works are completed
- For the construction of the special screed, follow the screed manufacturer's installation instructions

Note: Please refer to the installation manual for more information.

■ PRODUCTS THAT COMPOSE THE SYSTEM

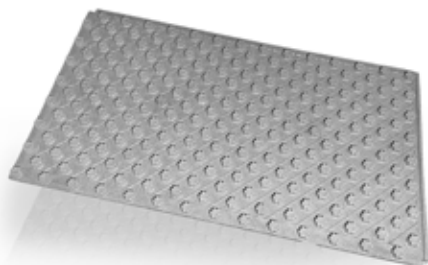

Super D17 Panel

Grooved insulation panel made of sintered expanded polystyrene with graphite complying with UNI EN 13163. High compressive strength (500 kPa). These panels have a tongue along the perimeter to connect them for proper combination. They have a moulded surface with reliefs of 19 mm so that the 17-mm pipe can be fitted into the tabs of the panel. Pipe spacing: 5 cm.

SIZE	THICKNESS	CODE
1400x800 mm	15 mm	1500215
1400x800 mm	34 mm	1500234

Panel characteristics	Symbol	15	34	Unit	Standard
Necessary length	L1	1400		mm	UNI EN 822
Necessary width	W1	800		mm	UNI EN 822
Total thickness	T4	34	53	mm	UNI EN 823
Insulation base thickness		15	34	mm	
Equivalent thickness		20	39	mm	UNI EN 1264/3
Resistance to compression with 10% deformation	CS(10)	500		kPa	UNI EN 826
Thermal conductivity 10 °C	λ_D	0.030		W/(m·K)	UNI EN 13163
Thermal resistance	R _D	0.65	1.30	(m ² ·K)/W	UNI EN 13163
Thermal transmittance	U	1.54	0.77	W/(m ² ·K)	
Water vapour diffusion resistance factor	μ (MU)	100 ±160			UNI EN 12086
Water vapour permeability	δ	0.004 ÷ 0.007		mg/(Pa·h·m)	UNI EN 12086
Dimension stability 48h / 70°C	DS(70,-)	≤1		%	UNI EN 1604
Fire reaction		E		Euroclass	UNI EN 13501-1
Long-term water absorption by total immersion	WL(T)	≤5		%	UNI EN 12087
Limit of operating temperature		70		°C	
EPS panel weight		1350	2600	g	
Specific heat	C	1450		J/kg·°k	UNI EN 10456
Declaration according to UNI EN 13163	EPS-EN 13163-T2-L3-W3-S2-P5-BS 750-CS(10)500-DS(70,-)1-WL(T)5-MU(40-100)				



RDZ Tech PE-Xa Pipe Ø 17 Interior Layer

RDZ Tech pipe Ø 17-13 made of high-density cross-linked polyethylene with the oxygen barrier between the PE-Xa layer and an outer layer made of PE, which ensures further protection during installation in the building site. The layers are combined thanks to a special glue. This pipe is produced according to DIN 16892 and DIN 4726 concerning oxygen permeability. This solution offers even and stable cross-links and constant characteristics over time. Natural colour

DIAMETER	ROLL	CODE
17-13 mm	240 m	1013840
17-13 mm	600 m	1013850

Note:
for further technical data see page 177



Slim 9 Perimeter Belt

The edge insulation Slim 9 absorbs floor expansions and acts as thermo-acoustic insulation for the walls.

SIZE	CODE
5x90 mm	1071100



Open Elbow

Open Ø 17 elbow made of plastic material. It is used to support the pipes near the manifolds vertically and to protect them from any damage.

SIZE	CODE
Ø 17 mm	1130517



Isocoll 160

One-component polyurethane adhesive. Moisture hardener with low viscosity, flexible in use. This solventless glue reacts to the moisture in the air and turns to a fine and restrained foam.

SIZE	CODE
500 gr	1111112

Tips for material calculation

Mandatory product	Requirements
SuperR D17 panel	Area to be covered +5%.
RDZ Tech pipe PE-Xa Ø 17	Based on the average laying pitch. Total = area / pitch [m ² /m]
Slim 9 perimeter belt	1 metre per m ²
Open elbow Ø 17	2 for each circuit
Isocoll 160	1 bottle each 5 m ² approx
Optional product	Requirements
Inibitor XR20	2% of WHOLE water content
Biocide XR40	1% of WHOLE water content

Manifolds, electrothermal heads, accessories and optional products (from page 162).

Note: The requirements in the table are indicative. Please refer to the construction project for confirmation.

THERMAL OUTPUT OF THE SYSTEM

Thermal output in heating

Input data			
Piper external diameter	d_o	0.017	m
Pipe wall thickness	s_R	0.002	m
Pipe heat conductivity	λ_R	0.35	W(m·k)

K_H															
$R_{\lambda,B} [m^2 \cdot k/W]$															
T cm	0.01	0.02	0.03	0.04	0.05	0.06	0.07	0.08	0.09	0.10	0.11	0.12	0.13	0.14	0.15
5	7,456	6,919	6,462	6,064	5,713	5,401	5,122	4,871	4,643	4,436	4,246	4,072	3,912	3,764	3,626
10	6,000	5,612	5,288	5,007	4,756	4,531	4,326	4,140	3,970	3,813	3,669	3,535	3,411	3,295	3,187
15	4,747	4,406	4,155	3,948	3,768	3,607	3,463	3,331	3,209	3,097	2,993	2,897	2,807	2,722	2,643

$R_{\lambda,B}$: Heat conduction resistance of the floor covering
 T: Pipe spacing

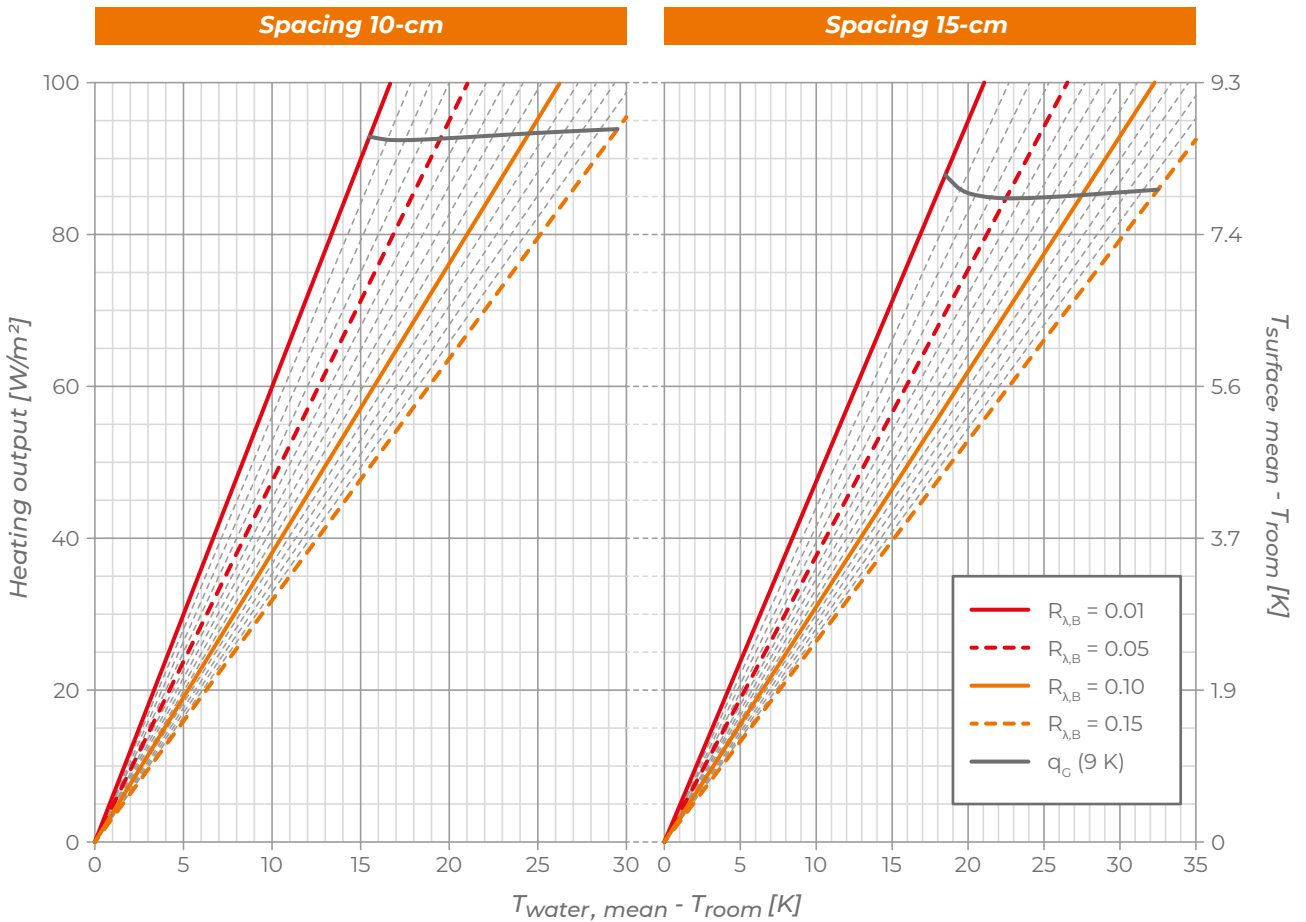

Thermal output in cooling

Input data			
Piper external diameter	d_o	0.017	m
Pipe wall thickness	s_R	0.002	m
Pipe heat conductivity	λ_R	0.35	W(m·k)

K_H															
$R_{\lambda,B} [m^2 \cdot k/W]$															
T cm	0.01	0.02	0.03	0.04	0.05	0.06	0.07	0.08	0.09	0.10	0.11	0.12	0.13	0.14	0.15
5	5,111	4,853	4,624	4,416	4,227	4,054	3,895	3,747	3,611	3,484	3,366	3,256	3,153	3,056	2,965
10	4,374	4,163	3,982	3,819	3,671	3,536	3,410	3,293	3,184	3,083	2,988	2,898	2,814	2,735	2,660
15	3,617	3,406	3,251	3,121	3,007	2,903	2,809	2,721	2,640	2,564	2,492	2,425	2,362	2,302	2,245

$R_{\lambda,B}$: Heat conduction resistance of the floor covering
 T: Pipe spacing

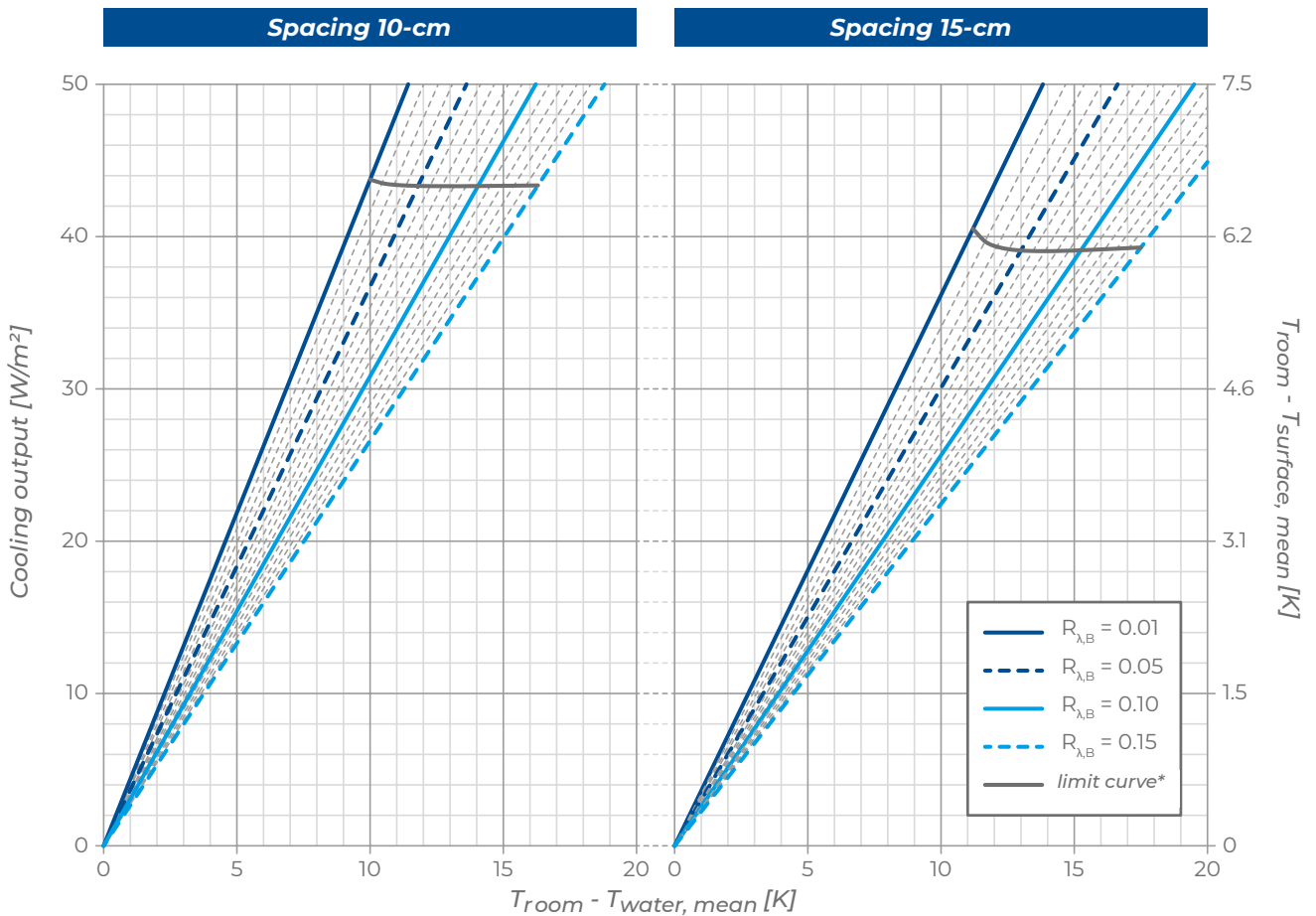

*valid only for room temperature = 26 °C

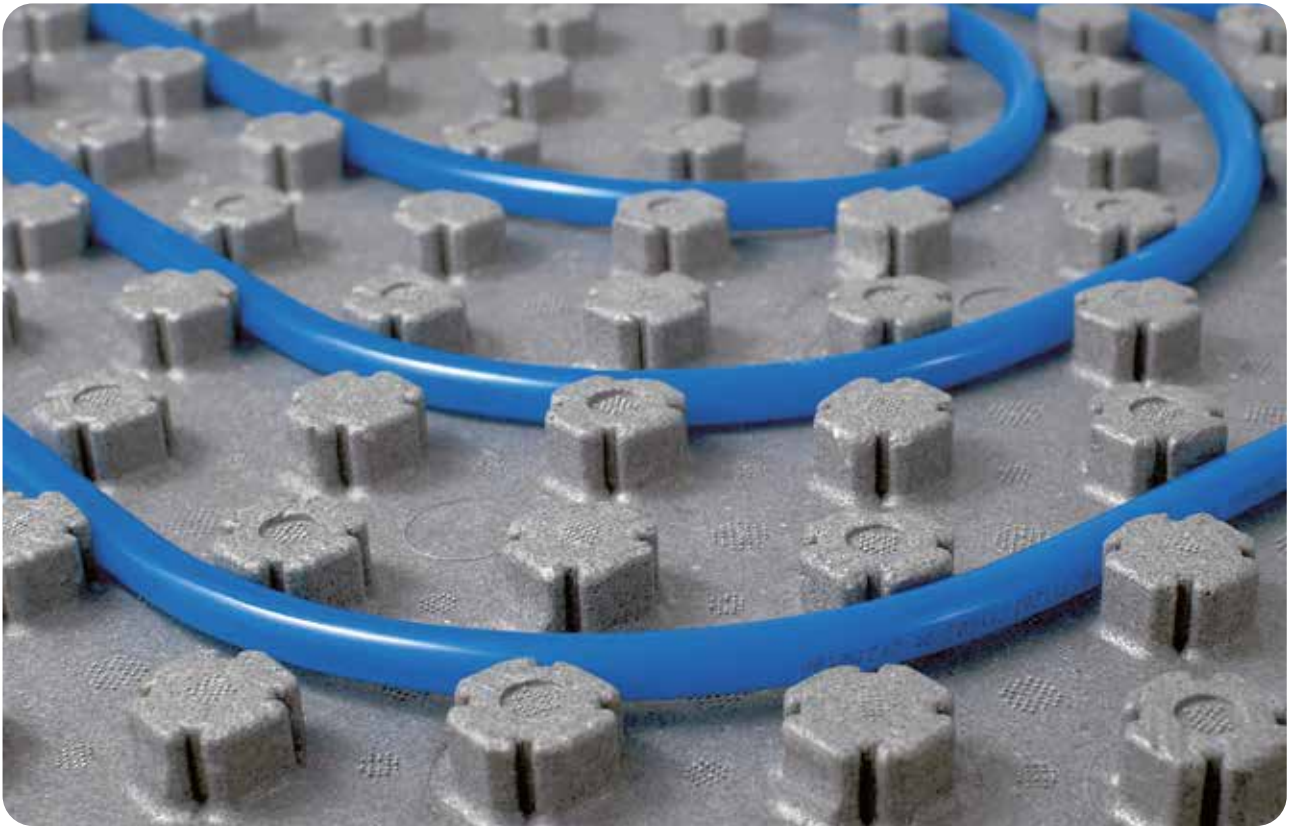

Super D is an underfloor heating and cooling system with low thermal inertia and low thickness, characterised by Ø 12 mm PB pipe anchored to an insulated base and embedded in the special lowered screed.

Thanks to its very small footprint, it is ideal for building renovations where the space available for the installation is limited. The low thermal inertia also makes it particularly suitable for contemporary buildings which, being low energy users, require rapid responsiveness to varying of thermal loads.

The central element of the system is the Super D studed panel made of sintered expanded polystyrene with graphite, in compliance with UNI EN 13163, characterised by extremely high mechanical resistance and available in a wide range of thicknesses to meet a variety of design and installation requirements. Designed to be glued to the substrate using a special polyurethane adhesive, it can also be placed on top of the existing flooring, avoiding its demolition.

The system is completed by the RDZ Clima PB pipe Ø 12 mm with excellent flexibility to facilitate the installation of the circuits, the open support elbows, the manifold, the Slim 9 perimeteric belt and the adhesive Isocoll 160 for gluing the panel to the substrate.

FEATURES

- Lowered system, low thermal inertia
- PB Ø 12 mm pipe (in special cases also PE-HD-Xc Ø 14 mm)
- Wide range of insulation thicknesses (10-20-30-40 mm)
- Possibility of gluing the panel to the existing flooring
- Ideal for renovations and contemporary buildings



SECTION AND DIMENSIONS

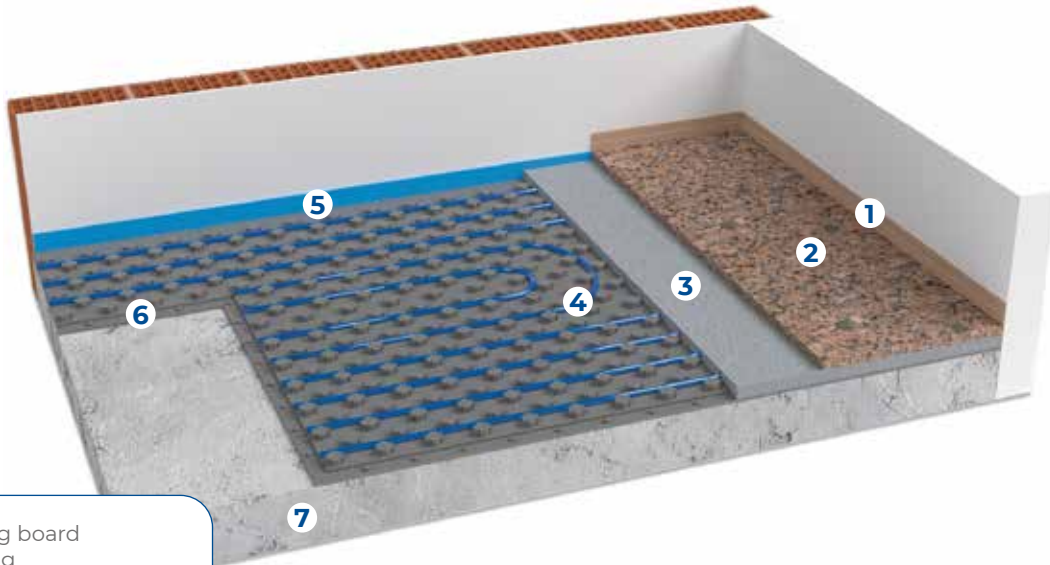

- 1 Skirting board
- 2 Flooring
- 3 Concrete
- 4 PB pipe Ø 12 mm
- 5 Perimeter belt
- 6 Super D panel
- 7 Stable, solid and planar subfloor



Weight of the system calculated with 10 mm level on top of the studs

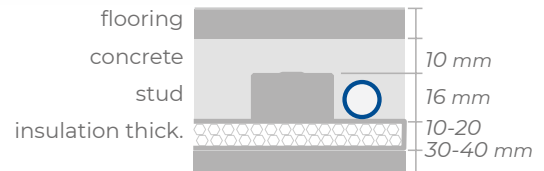

Indicative quotas (with 10 mm concrete)

Panel thickness	10 mm	20 mm	30 mm	40 mm
Quote with Tiles - Parquet flooring	4.6 - 5.6 cm	5.6 - 6.6 cm	6.6 - 7.6 cm	7.6 - 8.6 cm
Quote with Marble - Blockboard flooring	5.6 - 7.6 cm	6.6 - 8.6 cm	7.6 - 9.6 cm	8.6 - 10.6 cm

Suggested screeds

PRODUCER	SPECIAL LEVELLING SCREED
KNAUF	NE 425
KNAUF	NE 499
LECA	PaRis SLIM

Note: please refer to the Super D installation manual and the data sheets of the suggested products.

Installation notes

- If the floor is in direct contact with the ground (i.e. without a sanitary void or insulating sheathing), provide adequate waterproofing and subsequent levelling concrete
- Check the suitability of the substrate: flatness, surface suitable for gluing
- Check the available heights (minimum thickness of screed: 10 mm above the studs)
- Proceed with the installation of the perimeter belt
- After carefully cleaning the substrate by removing dust and residues, glue the panels with the appropriate adhesive
- Complete the system by laying the pipe as stated in the project
- Test the system and leave it under pressure until all subsequent installation and works are completed
- For the construction of the special screed, follow the screed manufacturer's installation instructions

Note: Please refer to the installation manual for more information.

■ PRODUCTS THAT COMPOSE THE SYSTEM



Super D Panel

Super D panel with studs made of waterproof sintered expanded polystyrene with graphite, produced in conformity with UNI EN 13163, with closed-cell structure and high compression strength (≥ 500 kPa). These panels have a tongue along the perimeter to connect them for proper combination. They have a moulded surface with reliefs of 16 mm so that the polybutylene pipes $\varnothing 12 \times 1.3$ mm can be fitted into the tabs of the panel at spacing of 4 cm or multiples.

SIZE	THICKNESS	CODE
1200x640 mm	10 mm	1500110
1200x640 mm	20 mm	1500120
1200x640 mm	30 mm	1500130
1200x640 mm	40 mm	1500140

Panel characteristics	Symbol	10	20	30	40	Unit	Standard
Necessary length	L3	1200				mm	UNI EN 822
Necessary width	W3	640				mm	UNI EN 822
Total thickness	T2	26	36	46	56	mm	UNI EN 823
Insulation base thickness		10	20	30	40	mm	
Equivalent thickness		13.3	23.3	33.3	43.3	mm	UNI EN 1264/3
Resistance to compression with 10% deformation	CS(10)	≥ 500				kPa	UNI EN 826
Thermal conductivity 10 °C	λ_D	0.032				W/(m·K)	UNI EN 13163
Thermal resistance	R_D	0.40	0.70	1.05	1.35	(m ² ·K)/W	UNI EN 13163
Thermal transmittance	U	2.50	1.43	0.95	0.74	W/(m ² ·K)	
Water vapour diffusion resistance factor	μ (MU)	40 \div 100					UNI EN 12086
Water vapour permeability	δ	0.006 \div 0.015				mg/(Pa·h·m)	UNI EN 12086
Dimension stability 48 h / 70 °C	DS(70,-)	≤ 1				%	UNI EN 1604
Fire reaction		E				Euroclass	UNI EN 13501-1
Long-term water absorption by total immersion	WL(T)	≤ 5				%	UNI EN 12087
Limit of operating temperature		70				°C	
Specific heat	C	1210				J/kg·°K	UNI EN 10456
Declaration according to UNI EN 13163	EPS-EN 13163-T2-L3-W3-S2-P5-BS 750-CS(10)500-DS(70,-)1-WL(T)5-MU(40-100)						



RDZ Klima pipe $\varnothing 12$

RDZ Klima pipe $\varnothing 12$ made of polybutylene with oxygen barrier, excellent flexibility for easy installation even in cold climates. It conforms to DIN 16968 and DIN 4726.

DIAMETER	ROLL	CODE
12 mm	300 m	1115120

Note:
for further technical data see page 173



Slim 9 Perimeter Belt

The edge insulation Slim 9 absorbs floor expansions and acts as thermo-acoustic insulation for the walls.

SIZE	CODE
5x90 mm	1071100



Open Elbow

Open Ø 12 elbow made of plastic material. It is used to support the pipes near the manifolds vertically and to protect them from any damage.

SIZE	CODE
Ø 12 mm	1130512



Isocoll 160

One-component polyurethane adhesive. Moisture hardener with low viscosity, flexible in use. This solventless glue reacts to the moisture in the air and turns to a fine and restrained foam.

SIZE	CODE
500 gr	1111112

Tips for material calculation

Mandatory product	Requirements
Super D Panel	Area to be covered +5%
RDZ Clima PB pipe Ø 12	Based on the average pitch. Total = area / pitch [m ² /m]
Slim 9 perimeter belt	1 metre per m ²
Open elbow Ø 12	2 for each circuit
Isocoll 160	1 bottle each 5 m ² approx
Optional product	Requirements
Inibitor XR20	2% of WHOLE water content
Biocide XR40	1% of WHOLE water content

Manifolds, electrothermal heads, accessories and optional products (from page 162).

Note: The requirements in the table are indicative. Please refer to the construction project for confirmation.

THERMAL OUTPUT OF THE SYSTEM

Thermal output in heating

Input data			
Screed coverings above the pipe	s_U	0.01	m
Heat conductivity of screed	λ_E	1.4	W(m·k)
Piper external diameter	d_o	0.012	m
Pipe wall thickness	s_R	0.0013	m
Pipe heat conductivity	λ_R	0.22	W(m·k)

K_H															
$R_{\lambda,B} [m^2 \cdot k/W]$															
T cm	0.01	0.02	0.03	0.04	0.05	0.06	0.07	0.08	0.09	0.10	0.11	0.12	0.13	0.14	0.15
8.1	7.125	6.596	6.158	5.779	5.448	5.153	4.890	4.653	4.438	4.242	4.063	3.898	3.747	3.606	3.476
12.2	5.696	5.233	4.889	4.605	4.360	4.145	3.952	3.778	3.620	3.476	3.343	3.220	3.106	3.000	2.901
16.3	4.893	4.453	4.154	3.916	3.715	3.540	3.384	3.244	3.116	2.998	2.891	2.791	2.698	2.612	2.531

$R_{\lambda,B}$: Heat conduction resistance of the floor covering
 T: Pipe spacing

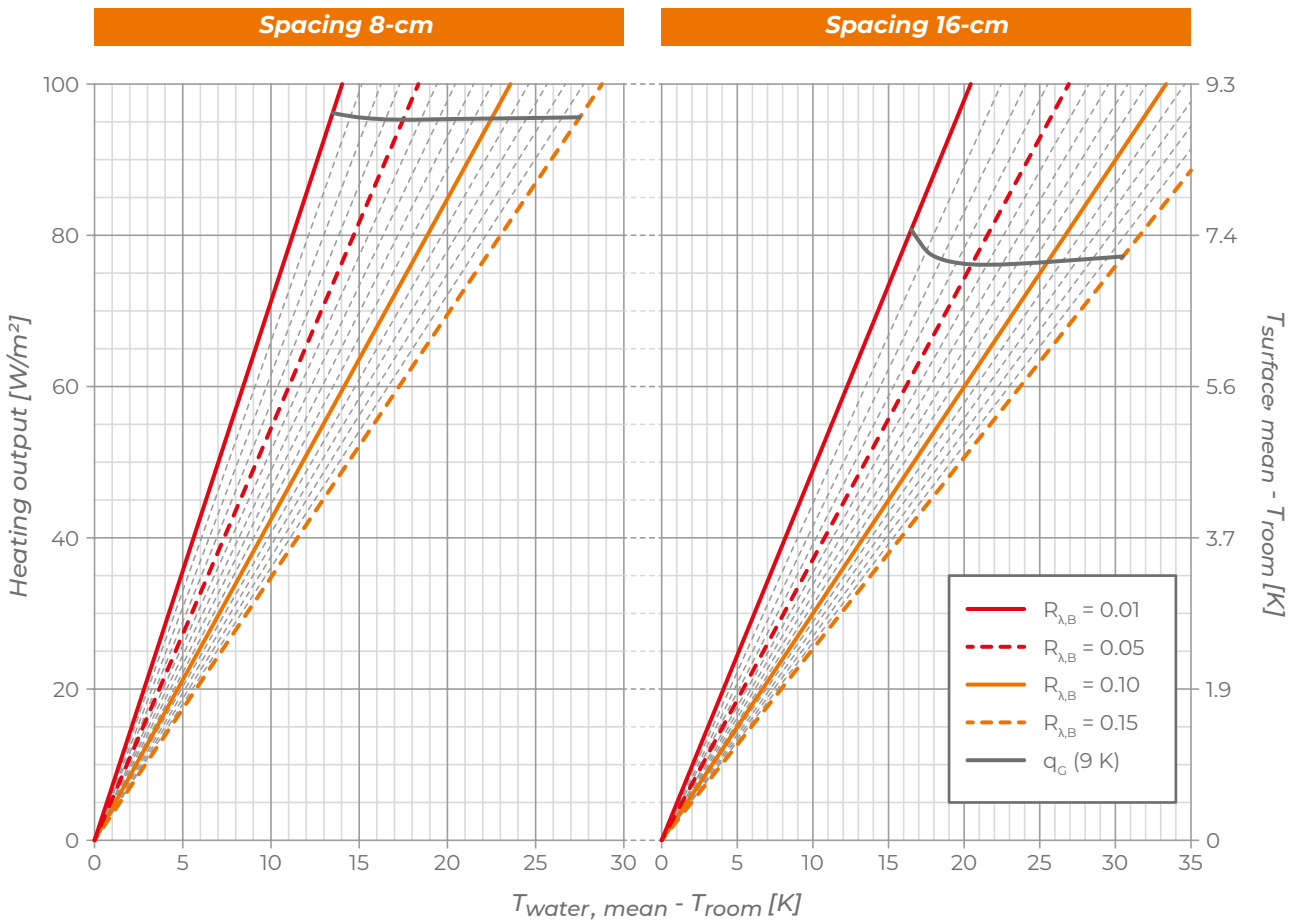

Thermal output in cooling

Input data			
Screed coverings above the pipe	s_U	0.01	m
Heat conductivity of screed	λ_E	1.4	W(m·k)
Piper external diameter	d_o	0.012	m
Pipe wall thickness	s_R	0.0013	m
Pipe heat conductivity	λ_R	0.22	W(m·k)

K_H															
$R_{\lambda,B} [m^2 \cdot k/W]$															
T cm	0.01	0.02	0.03	0.04	0.05	0.06	0.07	0.08	0.09	0.10	0.11	0.12	0.13	0.14	0.15
8.1	4.897	4.639	4.416	4.216	4.036	3.871	3.720	3.580	3.451	3.331	3.219	3.115	3.017	2.925	2.838
12.2	4.095	3.835	3.640	3.476	3.333	3.203	3.085	2.977	2.877	2.783	2.697	2.615	2.539	2.467	2.399
16.3	3.608	3.342	3.160	3.015	2.892	2.782	2.682	2.592	2.508	2.430	2.358	2.290	2.226	2.166	2.109

$R_{\lambda,B}$: Heat conduction resistance of the floor covering
 T: Pipe spacing

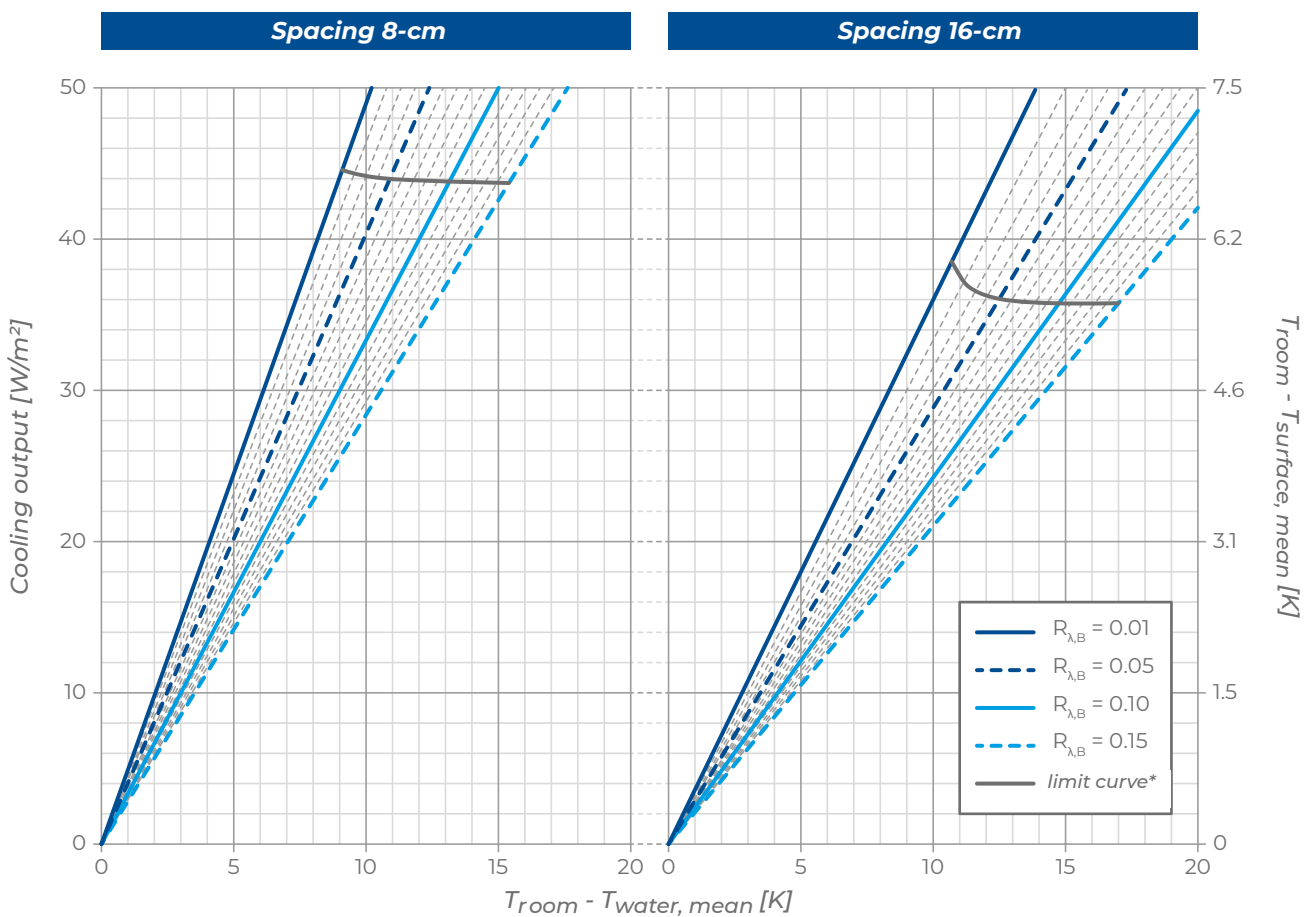

*valid only for room temperature = 26 °C



Zero Level AD is an underfloor heating and cooling system with low thermal inertia and very low thickness, characterised by \varnothing 12 mm PB pipe anchored to a thermoformed slab and embedded in the self-levelling concrete.

Thanks to its very small size, it is ideal for building renovation projects where the height available for the installation is limited.

The central element of the system is the thermoformed Zero Level AD panel, made of 1 mm thick regenerated plastic material. Used as a support for the pipe, it is equipped with a self-adhesive lower part for easy anchoring to the existing floor and with holes specially made to allow the self-levelling concrete to penetrate and cling to the substrate.

Without thermal insulation, the panel can be installed on top of any existing flooring or on an insulating support layer with a compressive strength greater than 400 kPa.

The system is completed by the RDZ Clima PB \varnothing 12 mm pipe with excellent flexibility to facilitate the installation of the circuits, the open support elbows, the manifold, the Slim 5 perimeteric belt and the Isocol 160 adhesive for gluing the panel to the substrate.

FEATURES

- Very low thickness and low thermal inertia system
- PB \varnothing 12 mm pipe
- Panel without insulation
- Possibility of gluing the panel to the existing flooring
- Ideal for renovations and contemporary buildings



SECTION AND DIMENSIONS



- 1 Skirting board
- 2 Flooring
- 3 Special liquid concrete
- 4 PB pipe Ø 12x1.3 mm
- 5 Slim 5 insulation edge
- 6 Zero Level AD Panel
- 7 Primer
- 8 Substrate + levelling



System weight calculated with 5 mm level on the studs



Indicatives quotas

Panel thickness	18 mm
Quote with Tiles - Parquet flooring	3.3 - 4.3 cm
Quote with Marble - Blockboard flooring	4.3 - 6.3 cm

Suggested screeds

PRODUCER	SPECIAL LEVELLING SCREED	PRIMER
BASF	PCI Periplan extra	PCI Gisogrund 404
MAPEI	Ultraplan Maxi Novoplan Maxi	ECOPRIM T
KNAUF	NE 425	E-Grund
ROFIX	FN 645	AP 300

Note: please refer to the Zero Level AD installation manual and the data sheets of the suggested products.

Installation notes

- If the floor is in direct contact with the ground (i.e. without a sanitary void or insulating sheathing), provide adequate waterproofing and subsequent self-levelling concrete
- Check the suitability of the substrate: flatness, surface suitable for gluing
- Check the available height (minimum thickness of concrete: 5 mm above the studs)
- Proceed with the installation of the perimeter belt
- After carefully cleaning the substrate by removing dust and residues, remove the protection film from the panel adhesive layer and add Isocoll 160 for a stronger gluing
- Complete the system by laying the pipe as stated in the project
- Test the system and leave it under pressure until all subsequent installation and works are completed
- For the construction of the special concrete, follow the screed manufacturer's installation instructions

Note: Please refer to the installation manual for more information.

PRODUCTS THAT COMPOSE THE SYSTEM

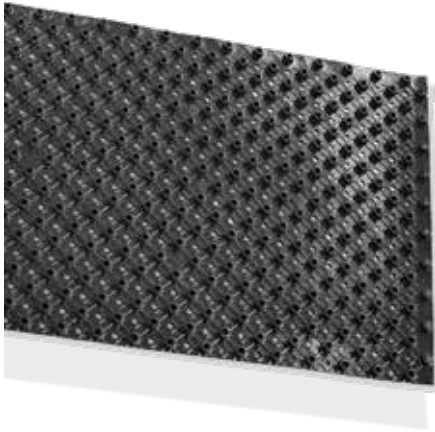

Level Zero AD Panel

Zero Level AD Panel is made of regenerated plastic material with high density and 1-mm thickness; it ensures a solid base in the building site and can be walked on. These panels have a tongue along the perimeter to connect them for accurate, secure join. Adhesive layer on the back, moulded surface with studs of 16 mm for 12-mm pipe laying, pipe spacing of 4 cm.

SIZE	THICKNESS	CODE
1215x810 mm	18 mm	1500000

Panel characteristics	Value	Unit	Standard
Size	1215x810x18	mm	
Thickness	1	mm	
Fluidity Index	4 ÷ 6	g/10min	ISO 1133
Vicat softening temperature	99	°C	ISO 306
Density at 23 °C	1.02 ÷ 1.05	g/cm ³	ASTM D792
Izod Impact Resistance at 23 °C	6 ÷ 8	KJ/m ²	ISO 180
Glue Specifications	Value	Unit	Standard
Viscosity according to Brookfield parameters at 160 °C	5.500	mPa/s	ICAT MI 13
Softening temperature	80	°C	ICAT MI 12
Open time at 160 °C	Limitless	s	ICAT MI 10



RDZ Climax PB Pipe Ø 12

RDZ Climax pipe Ø 12 made of polybutylene with anti-oxygen barrier, excellent flexibility for easy installation on low-temperature. It is produced in compliance with DIN 16968 and DIN 4726.

DIAMETER	ROLL	CODE
12 mm	300 m	1115120

Note:
for further technical data see page 173



Slim 5 Perimeter Belt

The edge insulation Slim 5 absorbs floor expansions and acts as thermo-acoustic insulation for the walls.

SIZE	CODE
5x50 mm	1200050



Open Elbow

Open Ø 12 elbow made of plastic material. It is used to support the pipes near the manifolds vertically and to protect them from any damage.

SIZE	CODE
Ø 12 mm	1130512



Isocoll 160

One-component polyurethane adhesive. Moisture hardener with low viscosity, flexible in use. This solventless glue reacts to the moisture in the air and turns to a fine and restrained foam.

SIZE	CODE
500 gr	1111112

Tips for material calculation

Mandatory product	Requirements
Level Zero AD panel	Area to be covered +5%
RDZ Clima PB pipe Ø 12	Based on the average laying pitch. Total = area / pitch [m ² /m]
Slim 5 perimeter belt	1 metre per m ²
Open elbow Ø 12	2 for each circuit
Isocoll 160	1 can each 16 m ² approx
Optional product	Requirements
Inibitor XR20	2% of WHOLE water content
Biocide XR40	1% of WHOLE water content

Manifolds, electrothermal heads, accessories and optional products (from page 162).

Note: The requirements in the table are indicative. Please refer to the construction project for confirmation.

THERMAL OUTPUT OF THE SYSTEM

Thermal output in heating

Input data			
Screed coverings above the pipe	s_U	0.005	m
Heat conductivity of screed	λ_E	1.4	W(m·k)
Piper external diameter	d_o	0.012	m
Pipe wall thickness	s_R	0.0013	m
Pipe heat conductivity	λ_R	0.22	W(m·k)

K_H															
$R_{\lambda,B} [m^2 \cdot k/W]$															
T cm	0.01	0.02	0.03	0.04	0.05	0.06	0.07	0.08	0.09	0.10	0.11	0.12	0.13	0.14	0.15
8.1	7.469	6.819	6.312	5.891	5.529	5.211	4.930	4.679	4.454	4.249	4.062	3.892	3.735	3.591	3.457
12.2	6.260	5.645	5.217	4.875	4.587	4.339	4.118	3.921	3.743	3.583	3.436	3.300	3.175	3.061	2.954
16.3	5.228	4.656	4.292	4.012	3.781	3.583	3.410	3.254	3.114	2.987	2.871	2.764	2.665	2.574	2.488

$R_{\lambda,B}$: Heat conduction resistance of the floor covering
 T: Pipe spacing

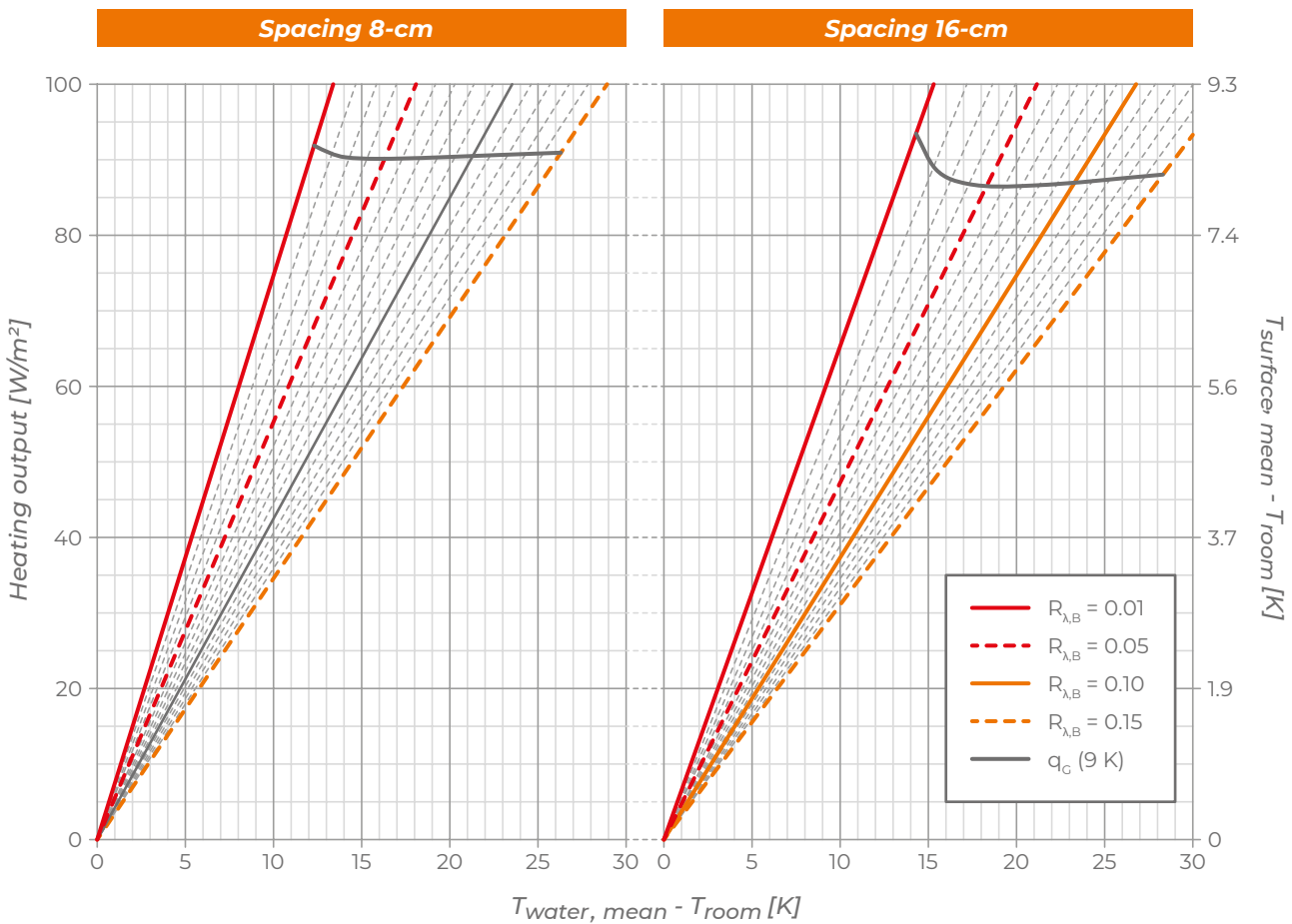

Thermal output in cooling

Input data			
Screed coverings above the pipe	s_U	0.005	m
Heat conductivity of screed	λ_E	1.4	W(m·k)
Piper external diameter	d_o	0.012	m
Pipe wall thickness	s_R	0.0013	m
Pipe heat conductivity	λ_R	0.22	W(m·k)

K_H															
$R_{\lambda,B} [m^2 \cdot k/W]$															
T cm	0.01	0.02	0.03	0.04	0.05	0.06	0.07	0.08	0.09	0.10	0.11	0.12	0.13	0.14	0.15
8.1	4.986	4.673	4.422	4.205	4.013	3.839	3.682	3.538	3.405	3.282	3.168	3.061	2.962	2.869	2.782
12.2	4.297	3.970	3.736	3.548	3.386	3.242	3.113	2.995	2.887	2.787	2.694	2.607	2.526	2.450	2.380
16.3	3.673	3.340	3.128	2.964	2.828	2.708	2.602	2.506	2.418	2.337	2.262	2.192	2.126	2.065	2.007

$R_{\lambda,B}$: Heat conduction resistance of the floor covering
 T: Pipe spacing

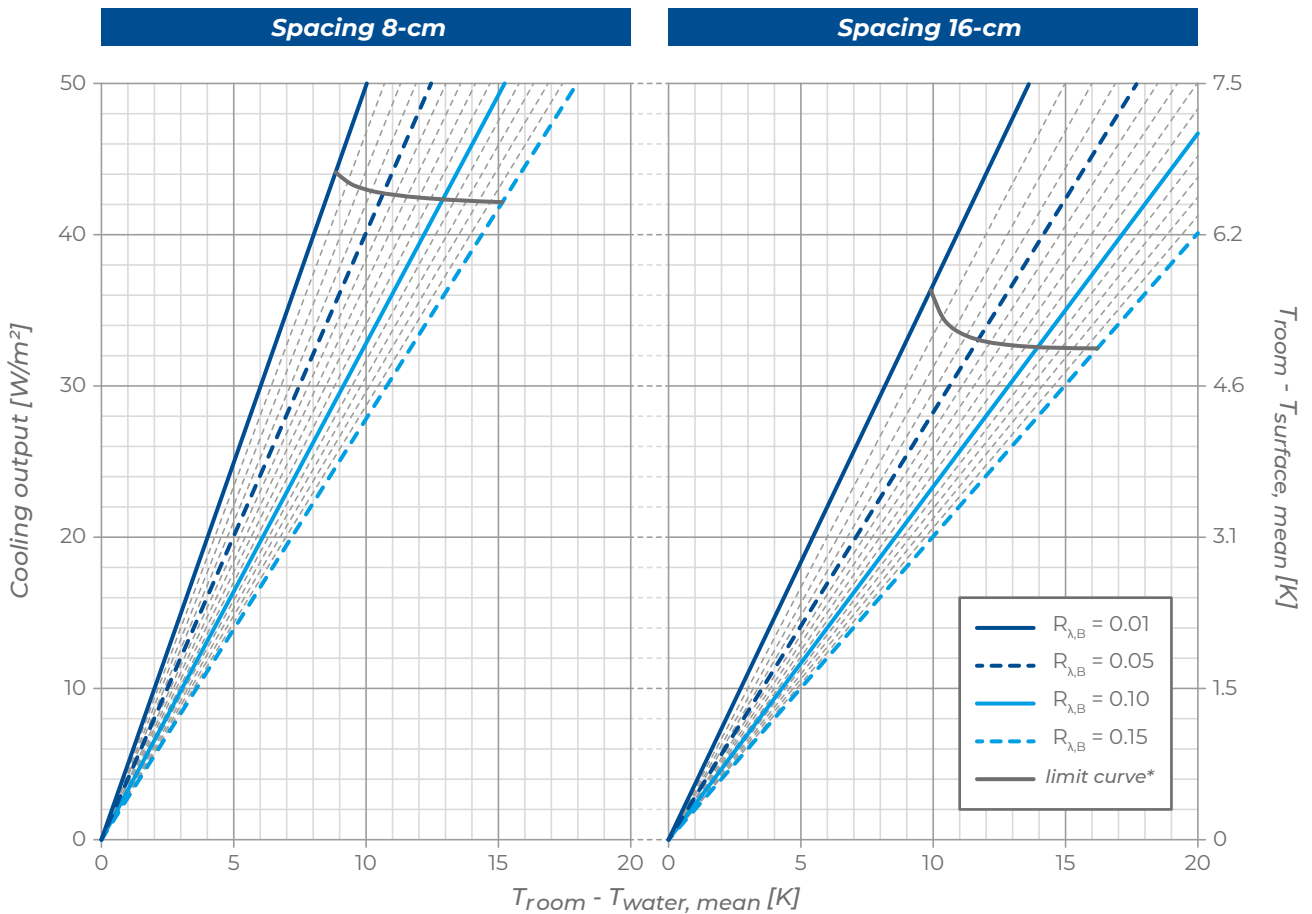

*valid only for room temperature = 26 °C

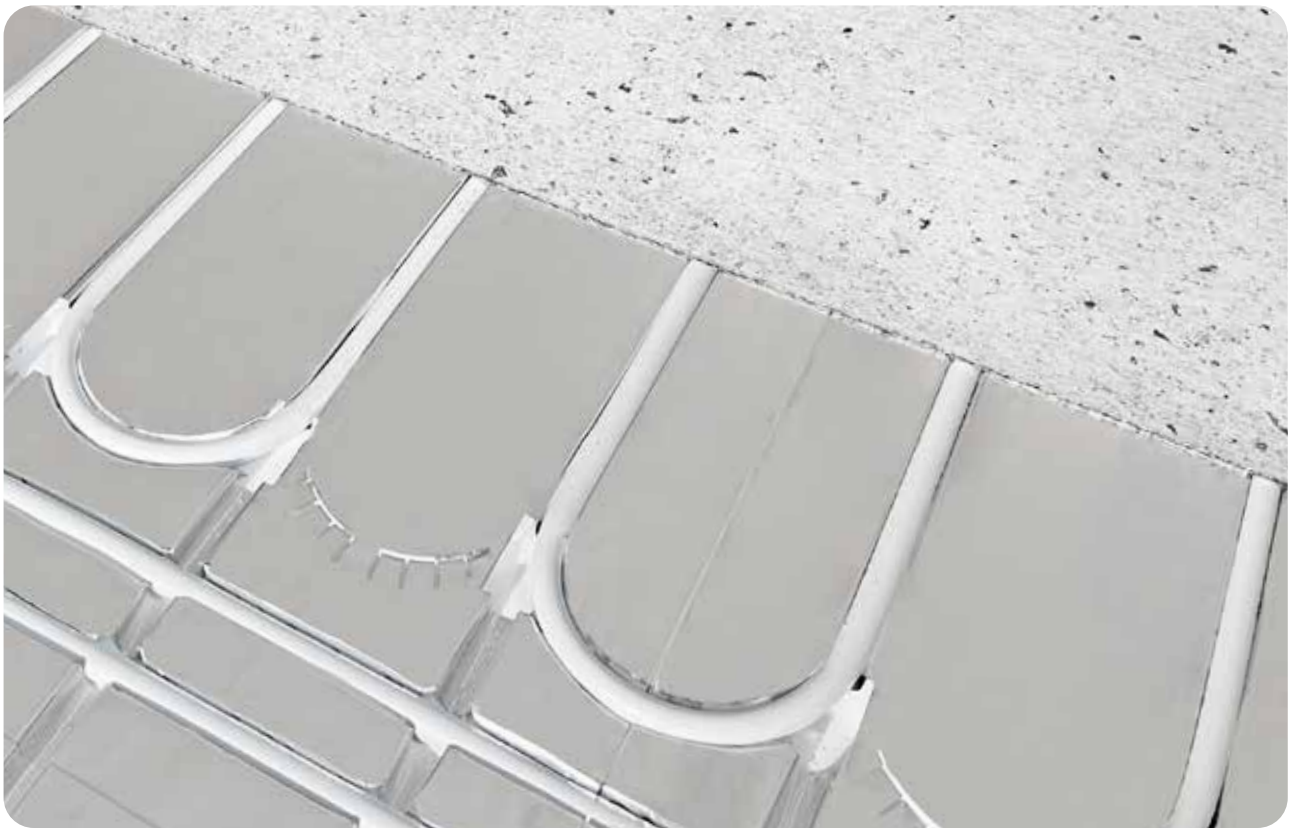

e-Dry Tech is an ultra-light dry underfloor heating and cooling system (weight less than 6 kg/m²) ideal in applications with limited available floor space or where the peculiarities of the building site make it difficult to use either traditional or lowered components.

The thickness of e-Dry Tech is only 29 mm, including both the panel and the load divider laid in place of the component. The absence of the component makes it possible to gain several centimetres in thickness, to have a floor immediately ready for flooring and makes the system operational without having to wait for the time needed for the component to dry.

The central element of the system is the e-Dry panel in sintered expanded polystyrene in compliance with UNI EN 13163, pre-coupled with an aluminium heat-diffusing layer and equipped with grooves to house the Ø 16 mm PE-RT/AL/PE-RT multilayer pipe.

The load divider is made up of laminated synthetic fibre sheets with very high mechanical resistance and impact noise attenuation properties. These, positioned over the radiant panel and joined together with RDZ paper adhesive tape, allow the creation of a single and uniform surface suitable for the application of the adhesive for the gluing of the tiles or to be covered with wood with a floating installation.

The system is completed with the pipe, the manifold, the Slim 5 perimeter belt, the open support elbows and the Isocoll 160 adhesive for gluing the panel to the substrate.

FEATURES

- Ultra-light dry system
- Only 2.9 cm thick (excluding flooring)
- Synthetic fibre load divider
- Multilayer Ø 16 mm pipe
- Ideal for mezzanines, renovations and contemporary buildings



SECTION AND DIMENSIONS

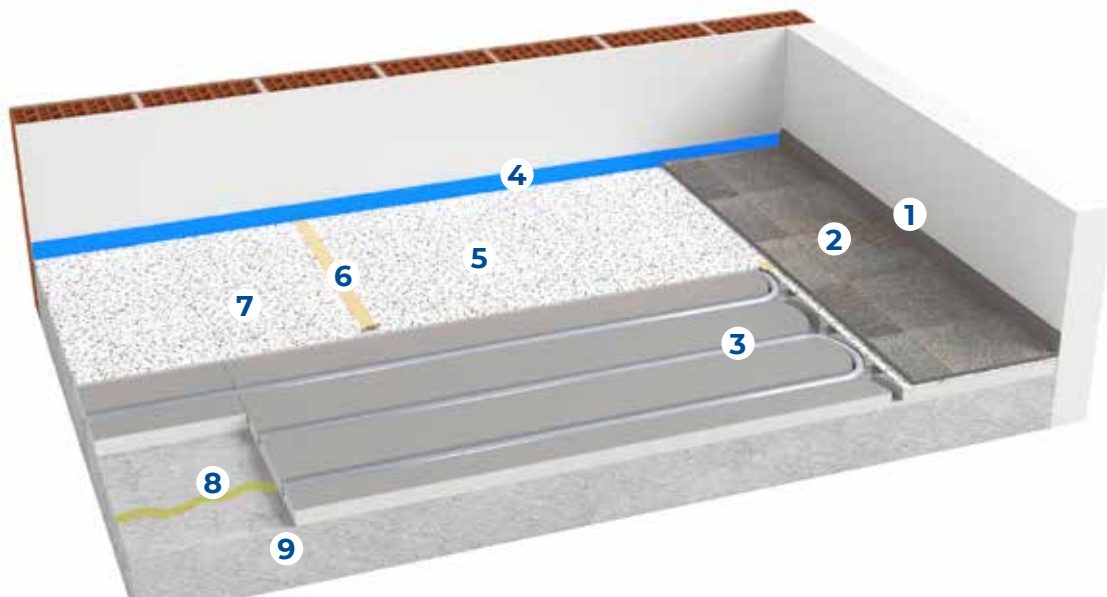

- 1 Skirting board
- 2 Flooring
- 3 Multilayer Pipe Ø 16
- 4 Slim 5 perimetral belt
- 5 Thermal diffuser
- 6 Paper adhesive tape
- 7 e-Dry panel
- 8 Isocoll 160
- 9 Substrate + levelling



Weight of the system

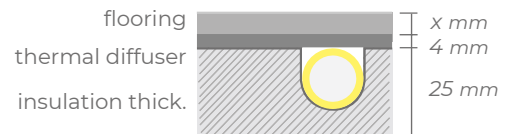

Indicatives quotas

Panel thickness	25 mm
Quote with Tiles - Parquet flooring	4.0 - 5.0 cm

For special coatings please refer to the installation manual

Installation notes

- If the floor is in direct contact with the ground (i.e. without a sanitary void or insulating sheathing), provide adequate waterproofing and subsequent levelling screed
- Check the suitability of the substrate: flatness, surface suitable for gluing
- Check the available dimensions
- Proceed with the installation of the perimeter belt
- After carefully cleaning the substrate by removing dust and material residues, glue the panels with the appropriate adhesive
- Lay the pipes as stated the project
- Test the system and leave it under pressure until all subsequent work is completed
- Coat the system with the synthetic fibre slabs joining them together using the appropriate adhesive paper tape

Note: Please refer to the installation manual for more information.

PRODUCTS THAT COMPOSE THE SYSTEM



e-Dry Panel

Grooved insulation panel made of sintered expanded polystyrene complying with UNI EN 13163 (EPS 300). Prefabricated and applied aluminium foil on the top surface for heat emission. Special grooves to support the pipe coming from manifold. Pipe spacing: 15cm.

SIZE	THICKNESS	CODE
1200x750 mm	25 mm	1201006

Panel features	Level/Class	Value	Unit	Standard
Standard classification	Class	300		
Necessary Length	L(3)	1200 (± 3)	mm	UNI EN 13163:2015
Necessary Width	W(3)	750 (± 3)		
Total Thickness	T(2)	25 (± 2)		
Insulation base thickness		7		
Equivalent thickness		22,44		
Orthogonality	S(2)	± 2	mm/m	
Flatness	P(5)	5		
Thermal conductivity 10 °C		λ_D 0.032	W/(m·K)	
Calculated thermal resistance equivalent thickness		R_D 0.70	(m ² ·K)/W	
Resistance to compression with 10% deformation	CS(10)300	300	kPa	
Water vapour diffusion resistance factor		$\mu = 40 \div 100$		
Long-term water absorption by total immersion	WL(T) 6	≤ 6	%	
Water vapour permeability		$\delta = 0.006 \div 0.015$	mg/(Pa·h·m)	
Fire reaction of the product as placed on the market		Euroclass E		
Dimension stability 23 °C, 50% R.H.	DS(N)2	± 0.2	%	
Reaction to fire		Euroclass E		
Max. operating temperature		70	°C	
Unique identification code of the product-type according to UNI EN 13163				
Class 300 - EPS-UNI EN 13163:2015-T2-L3-W3-S2-P5-BS450-CS(10)300-WL(T)6-MU(40-100)				



Comfort Multilayer Pipe Ø 16

PE-RT Type II/Al/PE-RT Type II multilayer pipe Ø 16x2 mm according to UNI EN ISO 21003.

THICKNESS	ROLL	CODE
2 mm	300 m	1030016

Note:
for further technical data see page 175



Tech Load Distribution Layer

Load distribution layer made of laminated synthetic fibre with very high compression strength and acoustic properties for trample noise reduction. Reaction to fire Class E according to EN 13501.

SIZE	CODE
1000x600x4 mm	1202110

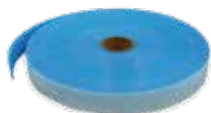

Slim 5 Perimeter Belt

The edge insulation Slim 5 absorbs floor expansions and acts as thermo-acoustic insulation for the walls.

SIZE	CODE
5x50 mm	1200050



Paper adhesive tape

Paper adhesive tape for fixing the synthetic fibre load divider.

SIZE	CODE
50 m	1202165



Open Elbow

Open elbow Ø 17 made of plastic material. It is used to support the pipes near the manifolds vertically and to protect them from any damage.

SIZE	CODE
Ø 17 mm	1130517



Isocoll 160

One-component polyurethane adhesive. Moisture hardener with low viscosity, flexible in use. This solventless glue reacts to the moisture in the air and turns to a fine and restrained foam.

SIZE	CODE
500 gr	1111112

Tips for material calculation

Mandatory product	Requirements
e-Dry panel	Area to be covered +10%
Comfort Multilayer Pipe Ø 16	Average laying pitch 15 cm. Total length = surface area/0.066 [m ² /m]
Slim 5 Perimeter Belt	1 metre per m ²
Tech Load Distribution Layer	Area to be covered +5%
Pape adhesive tape	1 metre per 2,7 m ²
Open elbow Ø 17	2 for each circuit
Isocoll 160	1 bottle each 4 m ²

Optional products	Requirements
Inibitor XR20	2% of WHOLE water content
Biocide XR40	1% of WHOLE water content

Manifolds, electrothermal heads, accessories and optional products (from page 162).

Note: The requirements in the table are indicative. Please refer to the construction project for confirmation.

THERMAL OUTPUT OF THE SYSTEM

Thermal output in heating

Input data			
Piper external diameter	d_o	0.016	m
Pipe wall thickness	s_R	0.002	m
Pipe heat conductivity	λ_R	0.45	W(m·k)

K_H																
$R_{\lambda,B} [m^2 \cdot k/W]$																
T cm	0.00	0.01	0.02	0.03	0.04	0.05	0.06	0.07	0.08	0.09	0.10	0.11	0.12	0.13	0.14	0.15
15	4,716	4,523	4,346	4,182	4,030	3,890	3,760	3,639	3,526	3,420	3,319	3,223	3,130	3,038	2,948	2,857

$R_{\lambda,B}$: Heat conduction resistance of the floor covering
 T: Pipe spacing

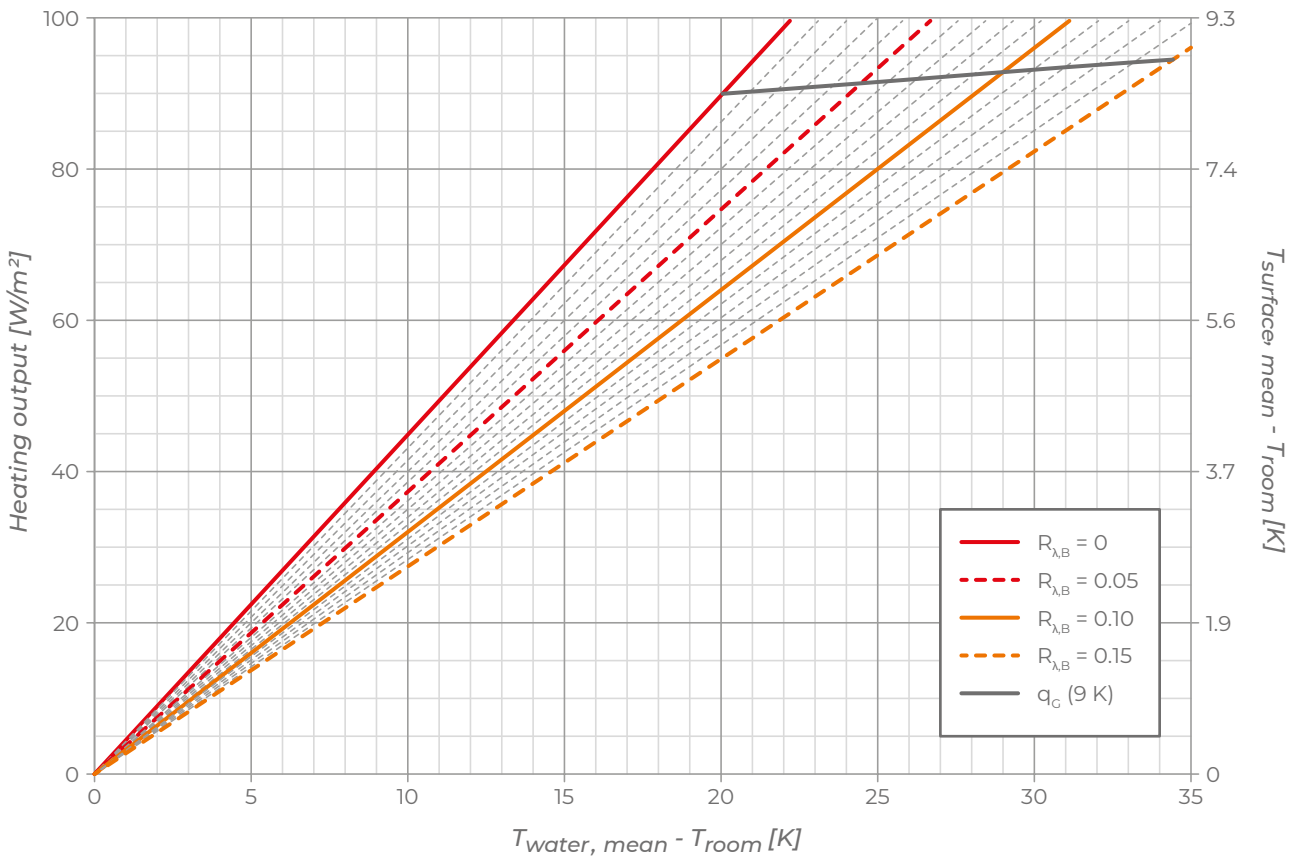

Thermal output in cooling

Input data			
Piper external diameter	d_a	0.016	m
Pipe wall thickness	s_R	0.002	m
Pipe heat conductivity	λ_R	0.45	W(m·k)

K_H																
$R_{\lambda,B} [m^2 \cdot k/W]$																
T cm	0.00	0.01	0.02	0.03	0.04	0.05	0.06	0.07	0.08	0.09	0.10	0.11	0.12	0.13	0.14	0.15
15	3,747	3,625	3,511	3,404	3,303	3,208	3,120	3,036	2,956	2,881	2,809	2,740	2,673	2,608	2,544	2,482

$R_{\lambda,B}$: Heat conduction resistance of the floor covering
 T: Pipe spacing

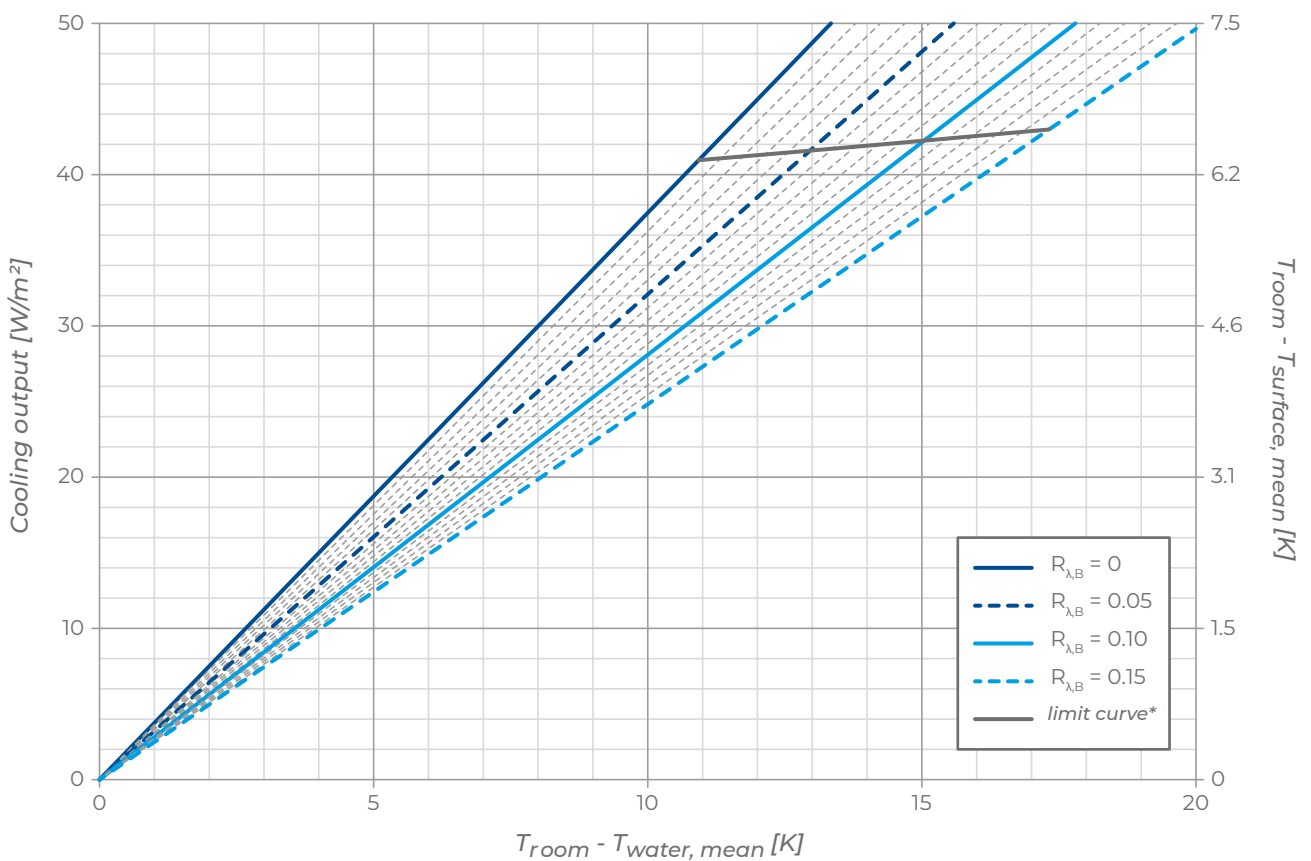

*valid only for room temperature = 26 °C



e-Dry EVO is a dry underfloor heating and cooling system ideal for renovations, lofts and all contemporary buildings that require very high energy efficiency.

In fact, e-Dry Evo is only 34 mm thick, including both the panel and the load distribution board installed instead of the concrete. The absence of the concrete makes it possible to gain several centimetres in thickness, to have a floor immediately ready for flooring and makes the system operational without waiting the time needed for the concrete to dry.

The central element of the system is the e-Dry panel in sintered expanded polystyrene in compliance with UNI EN 13163, pre-coupled with an aluminium heat-diffusing layer and equipped with grooves to house the $\varnothing 16$ multilayer PE-RT/AL/PE-RT pipe.

The load distribution board, to be positioned above the radiant panel, consists of fireproof, asbestos-free calcium silicate sheets reinforced with cellulose fibres and inorganic additives. Thanks to the hinging, these allow the creation of a single surface without interruptions, suitable for the application of adhesive for the gluing of tiles or to be covered with wood floating installation.

The system is completed with the manifold, the Slim 5 perimeter belt, the open support elbows and Isocoll 160 for gluing the panel to the substrate.

FEATURES

- Very light dry system
- Only 3.4 cm thickness (excluding flooring)
- Calcium silicate load distributor
- Multilayer pipe $\varnothing 16$ mm
- Ideal for renovations and contemporary buildings



SECTIONS AND DIMENSIONS

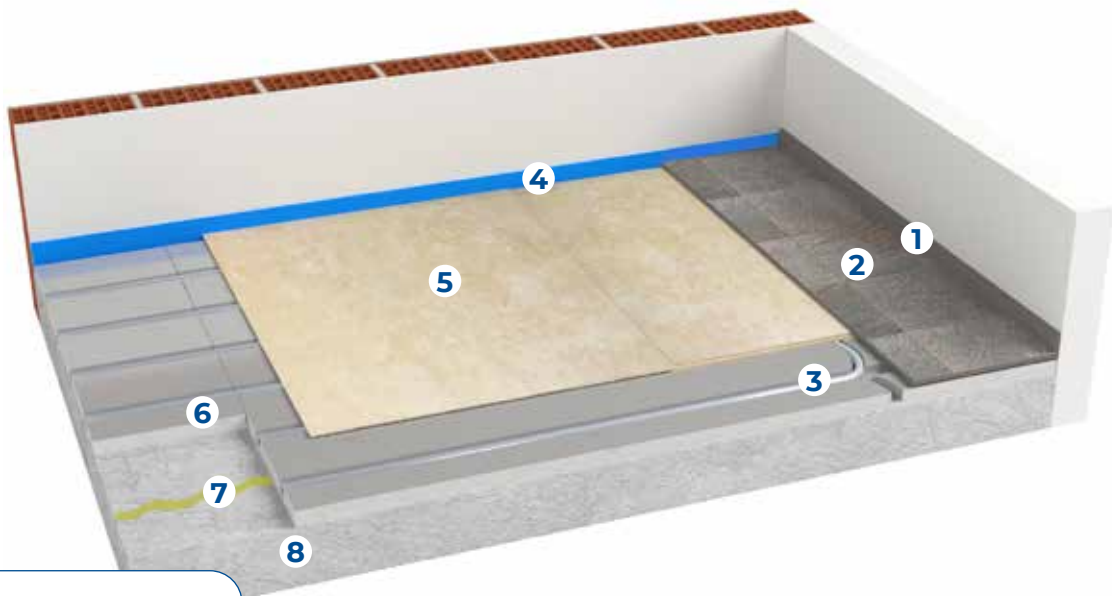

- 1 Skirting board
- 2 Flooring
- 3 Multilayer Pipe Ø 16
- 4 Slim 5 Perimeter Belt
- 5 Calcium Silicate Board
- 6 E-DRY Panel
- 7 Isocoll 160
- 8 Substrate + levelling



Weight of the system

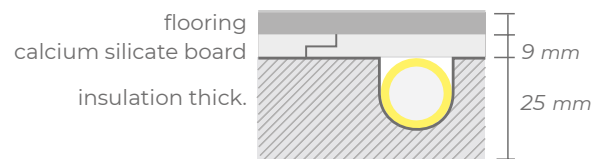

Indicative quotas

Panel thickness	25 mm
Quote with Tiles - Parquet flooring	4.5 - 5.5 cm

For special coatings please refer to the installation manual

Installation notes

- If the floor is in direct contact with the ground (i.e. without a sanitary void or insulating sheathing), provide adequate waterproofing and subsequent levelling screed
- Check the suitability of the substrate: flatness, surface suitable for gluing
- Check the available dimensions
- Proceed with the installation of the perimeter belt
- After carefully cleaning the substrate by removing dust and material residues, glue the panels with the appropriate adhesive
- Lay the pipes as stated the project
- Test the system and leave it under pressure until all subsequent works are completed
- Cover the system with calcium silicate slabs for even load distribution

Note: Please refer to the installation manual for more information.

PRODUCTS THAT COMPOSE THE SYSTEM



e-Dry Panel

Grooved insulation panel made of sintered expanded polystyrene complying with UNI EN 13163 (EPS 300). Prefabricated and applied aluminium foil on the top surface for heat emission. Special grooves to support the pipe coming from manifold. Pipe spacing: 15cm.

SIZE	THICKNESS	CODE
1200x750 mm	25 mm	1201006

Panel features	Level/Class	Value	Unit	Standard
Standard classification	Class	300		
Necessary Length	L(3)	1200 (± 3)	mm	UNI EN 13163:2015
Necessary Width	W(3)	750 (± 3)		
Total Thickness	T(2)	25 (± 2)		
Insulation base thickness		7		
Equivalent thickness		22,44		
Orthogonality	S(2)	± 2	mm/m	
Flatness	P(5)	5		
Thermal conductivity 10 °C		λ_D 0.032	W/(m·K)	
Calculated thermal resistance equivalent thickness		R_D 0.70	(m ² ·K)/W	
Resistance to compression with 10% deformation	CS(10)300	300	kPa	
Water vapour diffusion resistance factor		$\mu = 40 \div 100$		
Long-term water absorption by total immersion	WL(T) 6	≤ 6	%	
Water vapour permeability		$\delta = 0.006 \div 0.015$	mg/(Pa·h·m)	
Fire reaction of the product as placed on the market		Euroclass E		
Dimension stability 23 °C, 50% R.H.	DS(N)2	± 0.2	%	
Reaction to fire		Euroclass E		
Max. operating temperature		70	°C	
Unique identification code of the product-type according to UNI EN 13163				
Class 300 - EPS-UNI EN 13163:2015-T2-L3-W3-S2-P5-BS450-CS(10)300-WL(T)6-MU(40-100)				



Comfort Multilayer Pipe Ø 16

PE-RT Type II/Al/PE-RT Type II multilayer pipe Ø 16x2 mm according to UNI EN ISO 21003.

THICKNESS	ROLL	CODE
2 mm	300 m	1030016

Note:
for further technical data see page 175



Evo Load Distribution Layer

Tongue-and-groove board, made of hydrated calcium-silicate matrix reinforced with special cellulose fibres and inorganic additives. Reaction to fire Class A1 according to EN 13501.

SIZE	CODE
1200x1200x9 mm	1202255

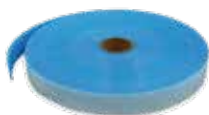

Slim 5 Perimeter Belt

The edge insulation Slim 5 absorbs floor expansions and acts as thermo-acoustic insulation for the walls.

SIZE	CODE
5x50 mm	1200050



Paper adhesive tape

Paper adhesive tape for fixing the synthetic fibre load divider.

SIZE	CODE
50 m	1202165



Open Elbow

Open elbow Ø17 made of plastic material. It is used to support the pipes near the manifolds vertically and to protect them from any damage.

SIZE	CODE
Ø 17 mm	1130517



Isocoll 160

One-component polyurethane adhesive. Moisture hardener with low viscosity, flexible in use. This solventless glue reacts to the moisture in the air and turns to a fine and restrained foam.

SIZE	CODE
500 gr	1111112

Tips for material calculation

Mandatory product	Requirements
e-Dry panel	Area to be covered +10%
Comfort Multilayer Pipe Ø 16	Average laying pitch 15 cm. Total length = surface area/0.066 [m ² /m]
Slim 5 Perimeter Belt	1 metre per m ²
Calcium Silicate Board	Area to be covered +5%
Open Elbow Ø 17	2 for each circuit
Isocoll 160	1 bottle each 4 m ²

Optional product	Requirements
Inibitor XR20	2% of WHOLE water content
Biocide XR40	1% of WHOLE water content

Manifolds, electrothermal heads, accessories and optional products (from page 162).

Note: The requirements in the table are indicative. Please refer to the construction project for confirmation..

THERMAL OUTPUT OF THE SYSTEM

Thermal output in heating

Input data			
Piper external diameter	d_o	0.016	m
Pipe wall thickness	s_R	0.002	m
Pipe heat conductivity	λ_R	0.45	W(m·k)

K_H																
$R_{\lambda,B} [m^2 \cdot k/W]$																
T cm	0.00	0.01	0.02	0.03	0.04	0.05	0.06	0.07	0.08	0.09	0.10	0.11	0.12	0.13	0.14	0.15
15	4,505	4,329	4,166	4,016	3,877	3,748	3,628	3,516	3,410	3,309	3,213	3,120	3,029	2,939	2,848	2,755

$R_{\lambda,B}$: Heat conduction resistance of the floor covering
 T: Pipe spacing

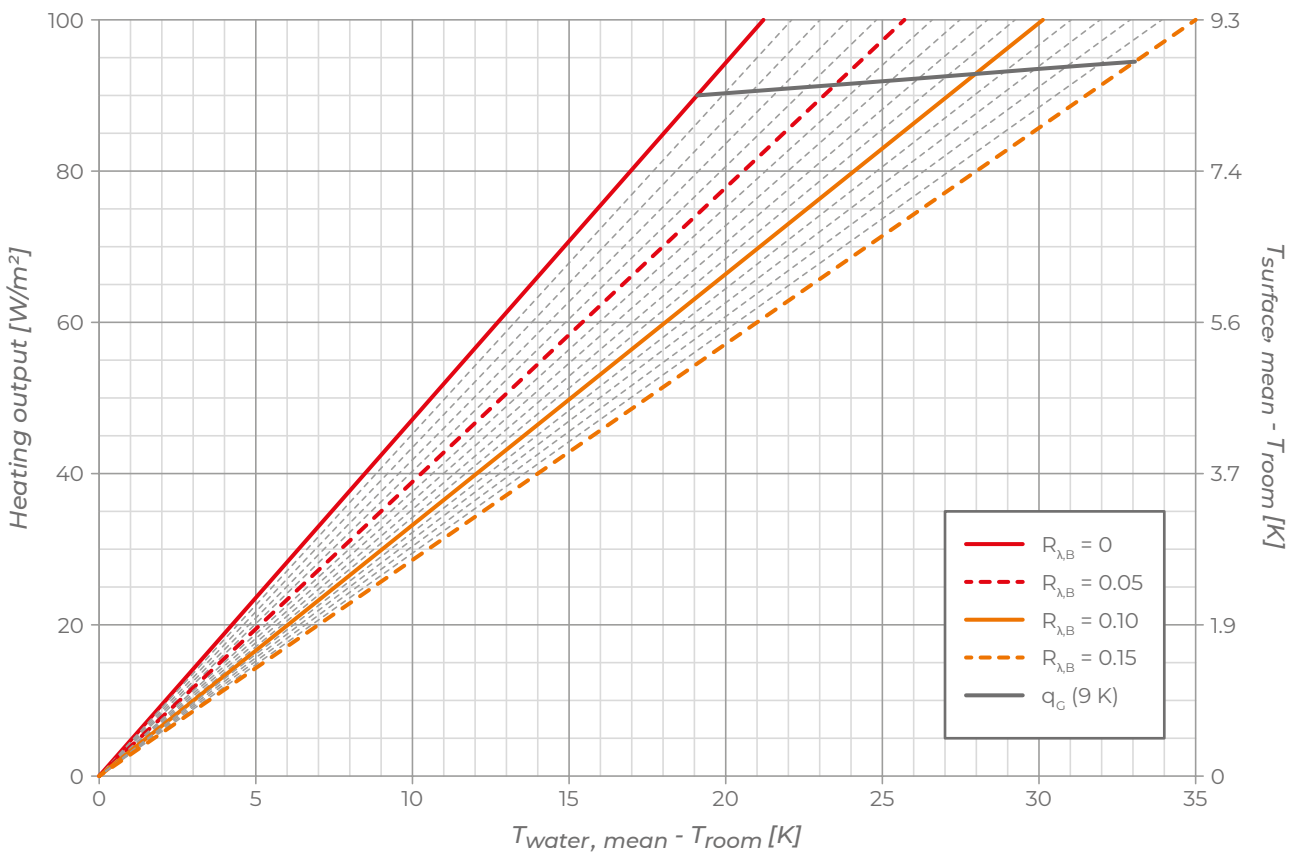

Thermal output in cooling

Input data			
Piper external diameter	d_a	0.016	m
Pipe wall thickness	s_R	0.002	m
Pipe heat conductivity	λ_R	0.45	W(m·k)

K_H																
$R_{\lambda,B} [m^2 \cdot k/W]$																
T cm	0.00	0.01	0.02	0.03	0.04	0.05	0.06	0.07	0.08	0.09	0.10	0.11	0.12	0.13	0.14	0.15
15	3,613	3,500	3,393	3,293	3,199	3,111	3,027	2,948	2,873	2,802	2,733	2,666	2,602	2,538	2,475	2,413

$R_{\lambda,B}$: Heat conduction resistance of the floor covering
 T: Pipe spacing

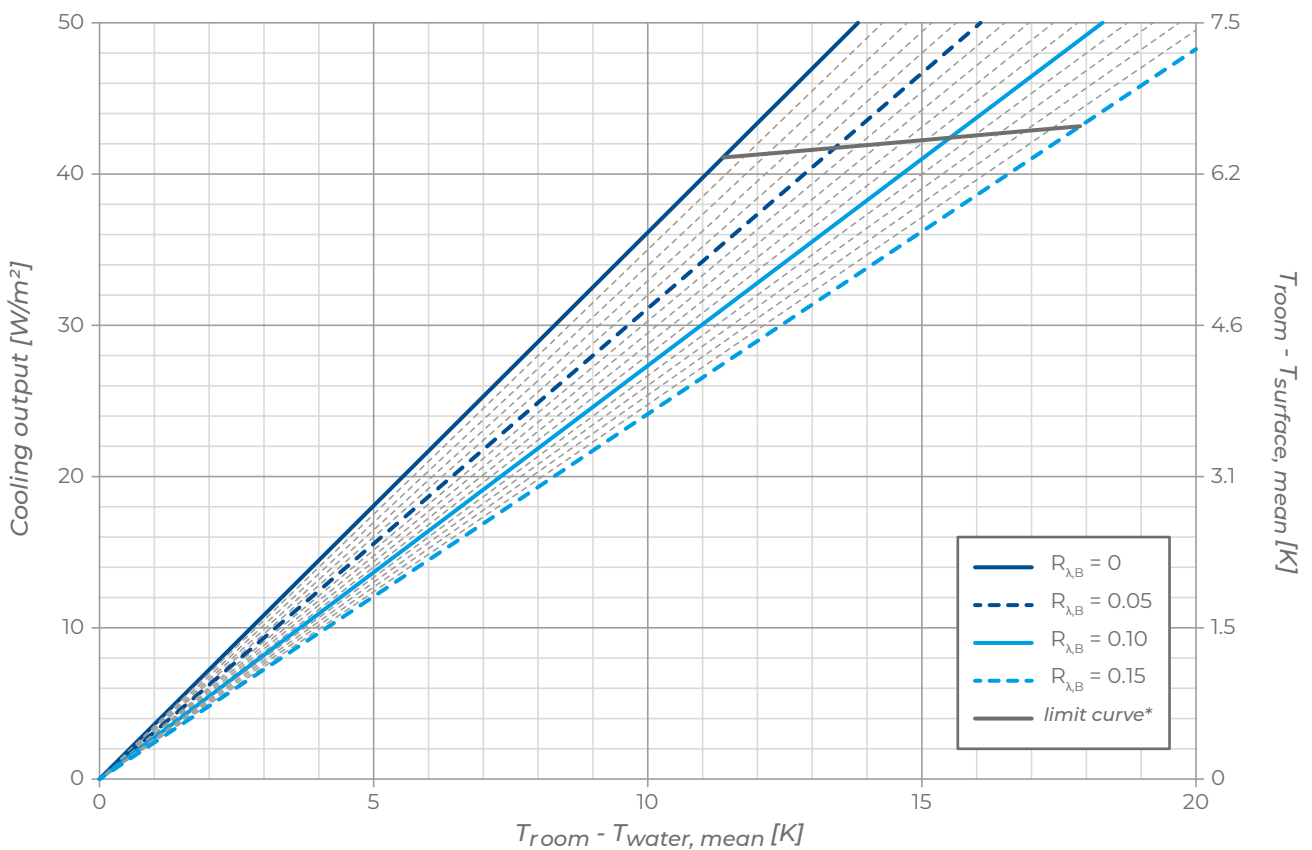

*valid only for room temperature = 26 °C



**Traditional underfloor
radiant system**





Comfort and consumptions reduced in every season

Traditional underfloor heating systems are the ideal choice for residential and commercial buildings, and for all rooms where it is necessary to maintain a constant internal temperature throughout the day.

Made with pipes anchored to an insulating base and embedded in the traditional screed, these systems can be used for both heating and cooling and are able to guarantee beautiful, spacious and clutter-free rooms, where the uniform distribution of temperature and the sensation of physical well-being are combined with considerable energy savings.

In order to meet various design and use requirements, traditional underfloor radiant systems are available in many versions with insulating panels of different composition and thickness: smooth or studded, with graphitic additives to improve thermal insulation performance, designed for greater mechanical resistance or specific for acoustics.

ADVANTAGES OF TRADITIONAL UNDERFLOOR SYSTEMS:



**WIDE RANGE
OF SOLUTIONS**



**UNIQUE SYSTEM FOR
HEATING AND COOLING**



**APPLICATION
VERSATILITY**



**EASY AND FAST
INSTALLATION**



**COMFORT AND
ENERGY SAVING**

PARAMETERS FOR THE CHOICE OF INSULATION

The following is explicitly about the parameters mentioned in the UNI EN 1264-4 standard, which suggests the minimum thermal resistance values to be respected depending on the thermal conditions underneath the room being heated with the floor.

	Below room heated	Unheated or non-continuously heated below room or directly on the ground*	Below outside air temperature		
			Design outside Temperature $T_d \geq 0^\circ\text{C}$	Design outside Temperature $0 > T_d \geq -5^\circ\text{C}$	Design outside Temperature $-5^\circ\text{C} > T_d \geq -15^\circ\text{C}$
Thermal Resistance $R_{\lambda,ins}$ ($\text{m}^2\text{K}/\text{W}$)	0.75	1.25	1.25	1.50	2.00
	"A"	"B"		"C"	"D"

(*) With a level of groundwater $\leq 5\text{ m}$ the value should be increased

Studded panels					
Panel type	Panel total thickness S [mm]	Equivalent thickness* of the panel S_{EQ} [mm]	Thermal resistance according to EN 1264(1) (with equivalent thk) $R_{\lambda,INS}$ [$\text{m}^2\text{K}/\text{W}$]	Thickness of the panel base S [mm]	Thermal resistance according to FprEN 1264(2) (with base thk) $R_{\lambda,INS}$ [$\text{m}^2\text{K}/\text{W}$]
COVER HP 24	52	32.97	0.75	24	0.60
COVER HP 39	67	47.97	1.25	39	0.95
COVER HP 47	75	55.97	1.50	47	1.20
COVER HP 62	90	70.97	2.00	62	1.70
COVER 20	48	29	0.80	20	0.55
COVER 30	58	39	1.10	30	0.85
ACOUSTIC PLUS 20	48	39.5	0.80	20	0.50
ACOUSTIC PLUS 30	58	40.5	1.05	30	0.80
NEW PLUS	33	18	0.50	12.5	0.35
TS0 21	47	28.7	0.80	21	0.60
TS0 30	56	36.8	1.05	30	0.85
TS0 40	66	46.8	1.35	40	1.10
TS0 46	72	52.8	1.50	46	1.30
TF-B HP 10	32	15	0.50	10	0.30
TF-B HP 18	40	23	0.75	18	0.60
TF-B HP 33	55	38	1.25	33	1.10
TF-B HP 40	62	45	1.50	40	1.30

(*) The equivalent panel thickness (SEQ) is understood as the geometric mean thickness.
 (1) Calculated on equivalent thickness (2) Calculated on base thickness only

Smooth panels			
Panel type	Panel total thickness S [mm]	Equivalent thickness* of the panel S_{EQ} [mm]	Thermal resistance according to EN 1264(1) (with equivalent thk) $R_{\lambda,INS}$ [$\text{m}^2\text{K}/\text{W}$]
ACURAPID B 20	20	20	0.50
ACURAPID B 30	30	30	0.75
SMOOTH COVER HP 24	24	24	0.75
SMOOTH COVER HP 39	39	39	1.25
SMOOTH COVER HP 47	47	47	1.50
SMOOTH COVER HP 62	62	62	2.00

SYSTEM CHOICE BY THICKNESS

System		Thickness [mm]	Pipe [mm]	Base [mm]	Stud/Clips [mm]	Concrete [mm]	Total [mm]			
Cover HP page 114		24	PE-X Ø 17	24	28	40	92			
		39	PE-X Ø 17	39	28	40	107			
		47	PE-X Ø 17	47	28	40	115			
		62	PE-X Ø 17	62	28	40	130			
Cover page 120		20	PE-X Ø 17	20	28	40	88			
		30	PE-X Ø 17	30	28	40	98			
Acoustic Plus page 126		20	PE-X Ø 17	20	28	40	88			
		30	PE-X Ø 17	30	28	40	98			
Acurapid page 132		20	PE-RT Ø 17	20	20	40	80			
		30	PE-RT Ø 17	30	20	40	90			
Smooth Cover HP page 138		24	PE-X Ø 17	PE-Xa Ø 20	24	20	23	40	84	87
		39	Ø 17	Ø 20	39	20	23	40	99	102
		47	Ø 17	Ø 20	47	20	23	40	107	110
		62	Ø 17	Ø 20	62	20	23	40	122	125
New Plus page 144		12.5	PE-X Ø 17	12.5	20.5	40	73			
T50 page 150		21	PE-X Ø 17	21	26	40	87			
		30	PE-X Ø 17	30	26	40	96			
		40	PE-X Ø 17	40	26	40	96			
		46	PE-X Ø 17	46	26	40	112			
TF-B HP page 156		10	PE-X Ø 17	10	22	40	72			
		18	PE-X Ø 17	18	22	40	80			
		33	PE-X Ø 17	33	22	40	95			
		40	PE-X Ø 17	40	22	40	102			



Cover HP is a traditional underfloor heating and cooling system with radiant panels, characterised by pipe anchored to the insulated base and embedded in the screed.

Invisible and efficient, it can be used in both residential and commercial applications and it is ideal for applications where it is necessary to maintain a constant room temperature throughout the day.

The central element of the system is the Cover HP studed panel made of sintered polystyrene with graphite and compliant with UNI EN 13163.

Available in a wide range of thicknesses (24, 39, 47 and 62 mm), it satisfies many different requirements and, thanks to the presence of graphite, offers excellent thermal insulation performance even with reduced overall dimensions.

The system is completed by RDZ Tech PE-X pipe \varnothing 17 mm made of high-density polyethylene, cross-linked and provided with anti-oxygen barrier according to DIN 4726, the hooked clips, the open support elbows, the manifold, the Cover HP smooth panel, the Plus perimeter belt and the 4S thermo-fluidifying additive.

FEATURES

- Sintered polystyrene panel with graphite
- RDZ Tech pipe \varnothing 17 mm
- Provides excellent thermal insulation
- Available in thicknesses 24-39-47-62 mm
- Suitable for residential and commercial applications
- Easy and quick installation



SECTION AND DIMENSIONS

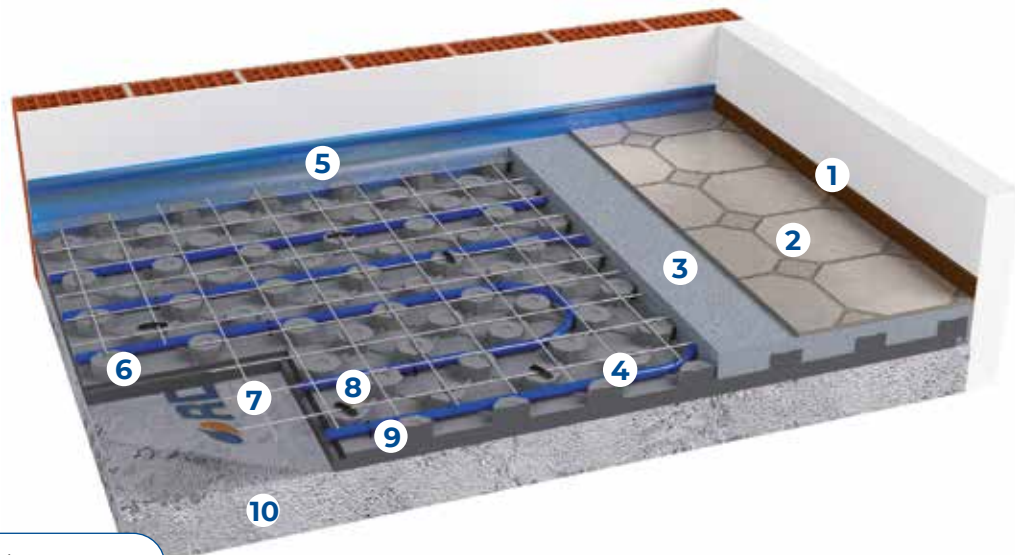

- 1 Skirting board
- 2 Flooring
- 3 Concrete
- 4 RDZ Tech pipe Ø 17-13
- 5 Plus perimeter belt
- 6 Cover HP panel
- 7 Anti-shrinkage mesh
- 8 Clip 75
- 9 Hooked clip
- 10 Substrate + levelling



Indicative quotas

Panel thickness	24 mm	39 mm	47 mm	62 mm
Quote with Tiles - Parquet flooring	10.2 - 11.2 cm	11.7 - 12.7 cm	12.5 - 13.5 cm	14 - 15 cm
Quote with Marble - Blockboard flooring	11.2 - 13.2 cm	12.7 - 14.7 cm	13.5 - 15.5 cm	15 - 17 cm

Installation notes

- If the floor is in direct contact with the ground (i.e. without a sanitary void or insulating sheathing), provide a polyethylene sheet to act as a moisture barrier.
- Check that the site is clear and clean
- Check the dimensions available, taking into consideration the thickness of the insulation, screed and flooring chosen.
- Lay the perimeter belt and the insulation panels
- Lay the pipes as stated the project
- Usually, it's not necessary to bend the pipe with a bending radius of less than 12.5 cm, i.e. with a laying pitch of less than 25 cm
- Test the system and leave it under pressure until all subsequent works are completed
- If necessary, install the anti-shrinkage mesh

Note: Please refer to the installation manual for more information.

PRODUCTS THAT COMPOSE THE SYSTEM

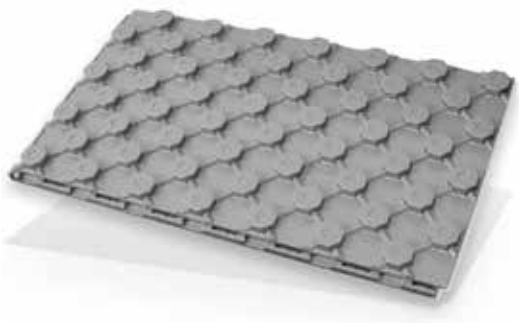

Cover HP Panel

Cover HP panel with studs made of waterproof sintered polystyrene with graphite, produced in conformity with UNI EN 13163, with closed-cell structure, which has high compression strength. It is combined with a special plastic film in order to protect it from humidity in compliance with EN 1264. They have a moulded surface with reliefs of 28 mm so that the pipes can be fitted into the tabs of the panel at spacing of 8.3 cm or multiples.

SIZE	THICKNESS	CODE
1161x663 mm	24 mm	1056324
1161x663 mm	39 mm	1056339
1161x663 mm	47 mm	1056347
1161x663 mm	62 mm	1056362

Panel features	Symbol	24	39	47	62	Unit	Standard
Necessary Length	L1	1161				mm	UNI EN 822
Necessary Width	W1	663				mm	UNI EN 822
Total Thickness	T4	52	67	75	90	mm	UNI EN 823
Insulation base thickness		24	39	47	62	mm	
Equivalent thickness		32.97	47.97	55.97	70.97	mm	UNI EN 1264/3
Compressive stress at 10% deformation	CS(10)	120				kPa	UNI EN 826
Thermal conductivity at 10 °C	λ_D	0.031				W/(m·K)	UNI EN 13163
Thermal resistance equivalent thickness	R_D	0.75	1.25	1.50	2.00	(m ² ·K)/W	UNI EN 1264
Transmittance	U	1.33	0.80	0.67	0.50	W/(m ² ·K)	
Water vapour diffusion resistance factor	μ (MU)	30÷70					UNI EN 12086
Dimension stability 48h/70°C	DS(70,-)	≤ 1				%	UNI EN 1604
Reaction to fire class		F				Euroclass	UNI EN 13501-1
Water absorption by partial immersion	WIp	0.5				kg/m ²	UNI EN 12087
Long-term water absorption by total immersion	WL(T)	≤ 3				%	UNI EN 12087
Max operating temperature		70				°C	
Specific heat	C	1210				J/kg·°k	UNI EN 10456
HIPS Foil thickness		150				µm	
Declaration according to UNI EN 13163							
Unique identification code of the product-type: EPS-EN 13163-T2-L3-W3-S2-P5-BS 170-CS(10)120-DS(70,-)1-WL(T)3-MU(30-70)							



COVER HP SMOOTH Panel

Smooth Cover HP panel is made of waterproof expanded polystyrene with graphite, produced in conformity with UNI EN 13163, with closed-cell structure, which has high compression strength. It is combined with a special plastic film in order to protect it from humidity in compliance with EN 1264.

SIZE	THICKNESS	CODE
1161x663 mm	24 mm	1056424
1161x663 mm	39 mm	1056439
1161x663 mm	47 mm	1056447
1161x663 mm	62 mm	1056462



RDZ Tech PE-Xa Pipe Ø 17 Interior Layer

RDZ Tech PE-Xa pipe Ø 17-13 made of high-density cross-linked polyethylene with the oxygen barrier between the PE-X layer and an outer layer made of PE, which ensures further protection during installation in the building site. The layers are combined thanks to a special glue.

TYPE	ROLL	CODE
PE-Xa	240 m	1013840
PE-Xa	600 m	1013850

Note: for further technical data see page 176



Plus Perimeter Belt

Plus perimeter belt is the edge insulation, which absorbs floor expansions and acts as thermo-acoustic insulation for the walls.

SIZE	CODE
5x150 mm	1071250



Hooked clip

Hooked clips made of plastic material to ensure secure positioning of the pipe on the insulating panels.

PACKAGE	CODE
100 pieces	1017000



Open Elbow

Open elbow Ø 17 made of plastic material. It is used to support the pipes near the manifolds vertically and to protect them from any damage.

SIZE	CODE
Ø 17 mm	1130517



Thermofluidifying Additive 4S

Superfluxing, multidosage, water reducing admixture for concrete to increase its workability and to improve its mechanical properties and thermal conductivity. It is a product which conforms to EN 934-2; T3.1 - 3.2.

SIZE	CODE
10 liters	1091911
20 liters	1091921

Tips for material calculation

Mandatory product	Requirements
Cover HP panel	Area to be covered +3%
Smooth Cover HP panel	1 pack each manifold
RDZ Tech pipe Ø 17 mm	Average pitch. Total = surface area / pitch [m ² /m]
Plus perimeter belt	1 metre per m ²
Open elbow Ø 17	2 for each circuit
Hooked clip	5 for each circuit
Thermofluidifying Additive 4S	Approx. 0.2 litres per m ²

Optional product	Requirements
Fibreglass Mesh	Area to be covered +10%
RDZ Fiber (polypropylene fibres)	1 kg per 16 m ²
Clip 75	To be used only if anti-shrinkage mesh is used. 5 clips/m ²
Humidity Barrier Sheet	Surface to be covered +20%
Inibitor XR20	2% of ENTIRE water content
Biocide XR40	1% of ENTIRE water content

Manifolds, electrothermal heads, accessories and optional products (from page 162).

Note: The requirements in the table are indicative. Please refer to the construction project for confirmation..

THERMAL OUTPUT OF THE SYSTEM

Thermal output in heating

Input data			
Screed coverings above the pipe	s_U	0.045	m
Heat conductivity of screed	λ_E	1.2	W(m·k)
Piper external diameter	d_o	0.017	m
Pipe wall thickness	s_R	0.002	m
Pipe heat conductivity	λ_R	0.35	W(m·k)

K_H																
$R_{\lambda,B} [m^2 \cdot k/W]$																
T cm	0.00	0.01	0.02	0.03	0.04	0.05	0.06	0.07	0.08	0.09	0.10	0.11	0.12	0.13	0.14	0.15
8.3	6.556	6.111	5.723	5.383	5.081	4.812	4.571	4.352	4.154	3.974	3.809	3.656	3.516	3.386	3.266	3.154
16.6	5.144	4.834	4.565	4.328	4.119	3.934	3.760	3.603	3.461	3.331	3.213	3.099	2.994	2.896	2.806	2.722
24.9	4.067	3.850	3.663	3.500	3.356	3.230	3.105	2.994	2.893	2.802	2.719	2.634	2.555	2.482	2.415	2.353

$R_{\lambda,B}$: Heat conduction resistance of the floor covering
 T: Pipe spacing

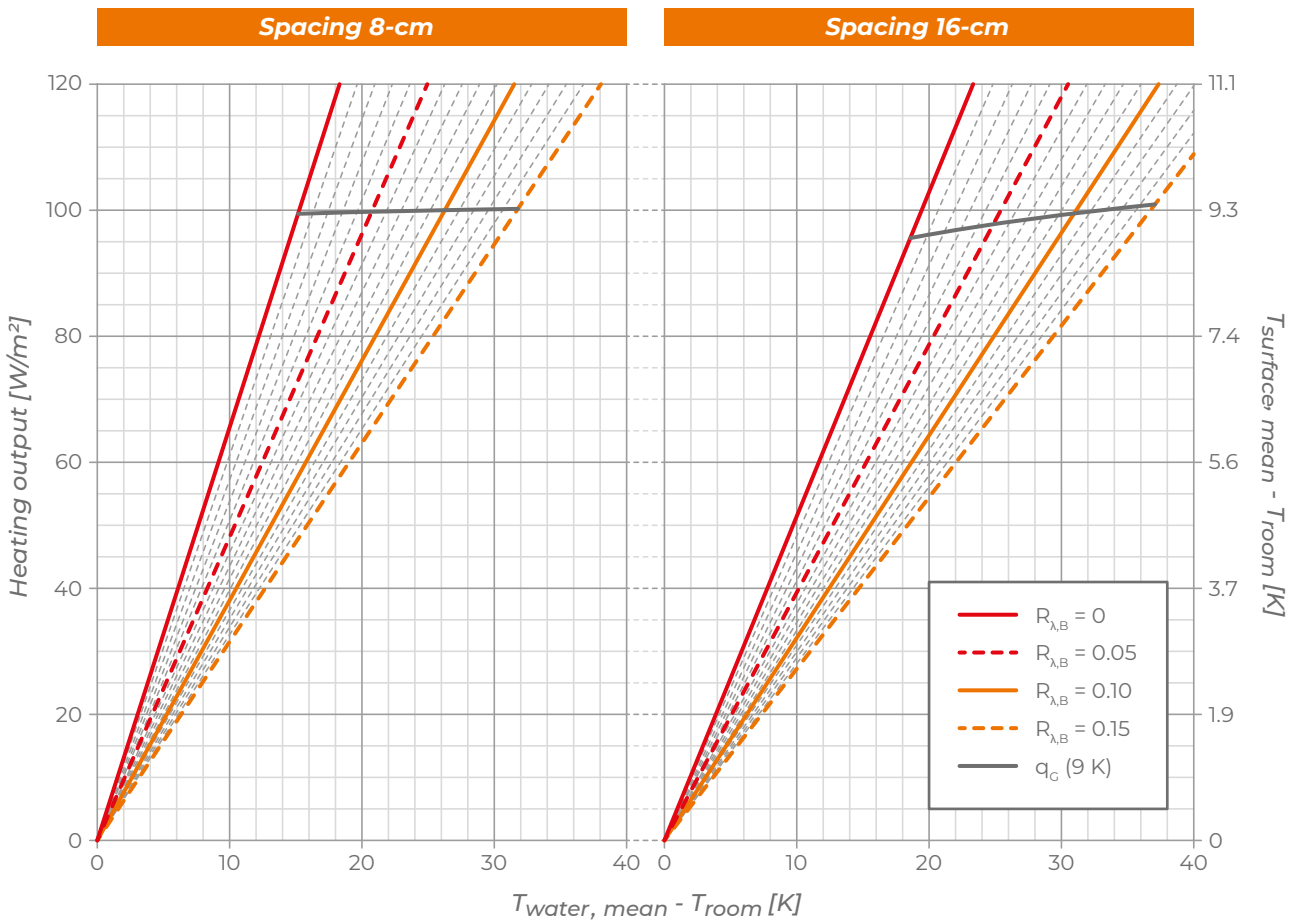

Thermal output in cooling

Input data			
Screed coverings above the pipe	s_U	0.045	m
Heat conductivity of screed	λ_E	1.2	W(m·k)
Piper external diameter	d_o	0.017	m
Pipe wall thickness	s_R	0.002	m
Pipe heat conductivity	λ_R	0.35	W(m·k)

K_H																
$R_{\lambda,B} [m^2 \cdot k/W]$																
T cm	0.00	0.01	0.02	0.03	0.04	0.05	0.06	0.07	0.08	0.09	0.10	0.11	0.12	0.13	0.14	0.15
8.3	4.551	4.334	4.138	3.958	3.793	3.642	3.502	3.372	3.252	3.140	3.035	2.938	2.846	2.760	2.679	2.602
16.6	3.774	3.616	3.471	3.338	3.214	3.099	2.992	2.893	2.799	2.712	2.630	2.552	2.479	2.410	2.345	2.283
24.9	3.135	3.022	2.916	2.818	2.727	2.641	2.560	2.484	2.413	2.345	2.281	2.221	2.163	2.109	2.057	2.008

$R_{\lambda,B}$: Heat conduction resistance of the floor covering
 T: Pipe spacing

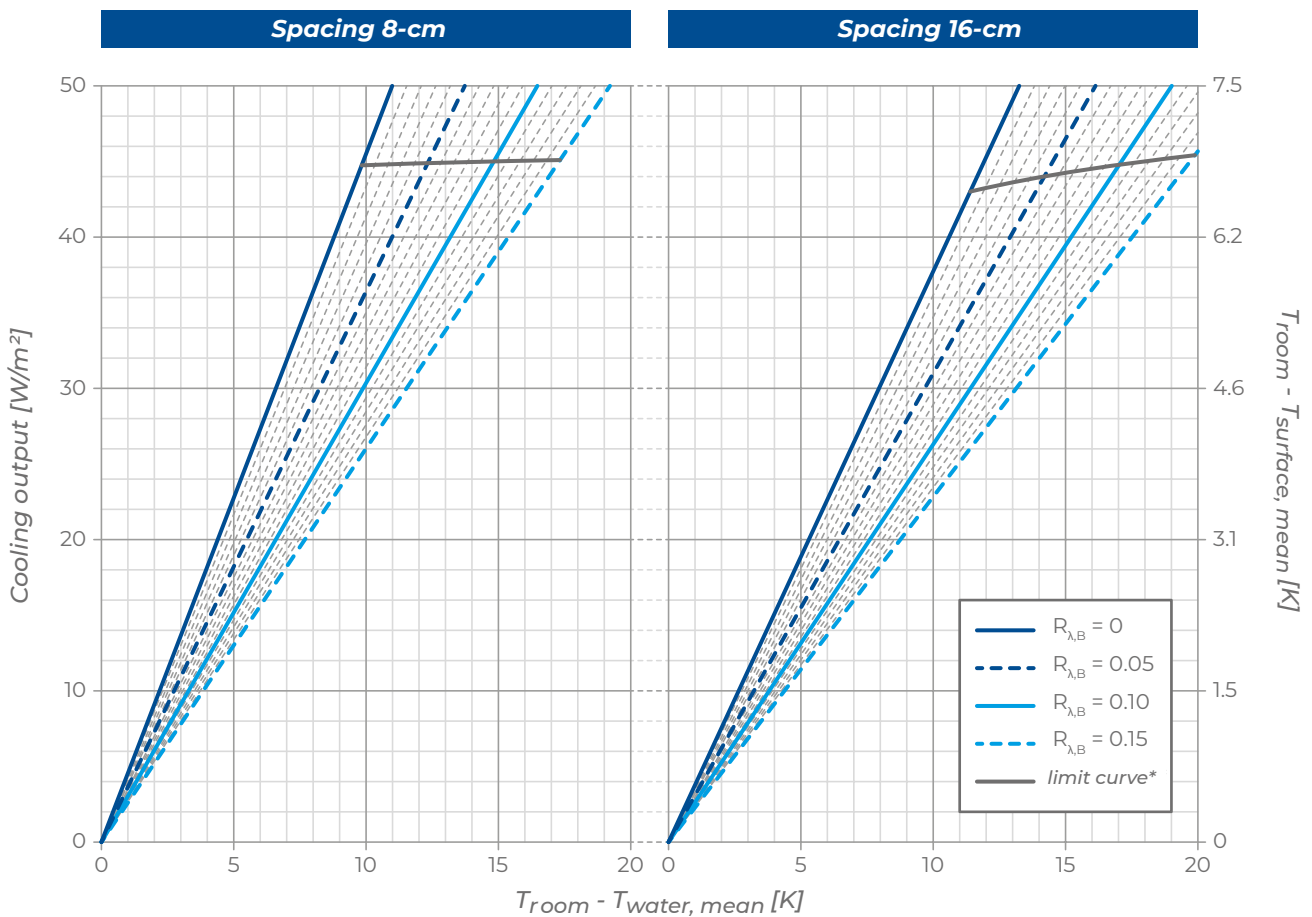

*valid only for room temperature = 26 °C



Cover is a traditional underfloor radiant heating and cooling system, characterised by pipe anchored to an insulated base and embedded in the screed.

Ideal for applications where it is necessary to maintain a constant room temperature throughout the day, it can be used in numerous applications ranging from the residential to the commercial applications.

The central element of the system is the studded Cover panel made of sintered expanded polystyrene produced in compliance with UNI EN 13163, coated on the surface with plastic film and available in thicknesses of 20 and 30 mm.

The system is completed by RDZ Tech PE-X pipe Ø 17 mm made of high-density cross-linked polyethylene and provided with anti-oxygen barrier according to DIN 4726, the hooked clips, the open support elbows, the manifold, the smooth Cover panel, the Plus perimeter belt and the 4S thermo-fluidifying additive.

FEATURES

- Excellent thermal insulation
- RDZ Tech Ø 17 mm
- High mechanical resistance of the panel
- Suitable for residential and commercial applications
- Easy and quick installation



SECTION AND DIMENSIONS

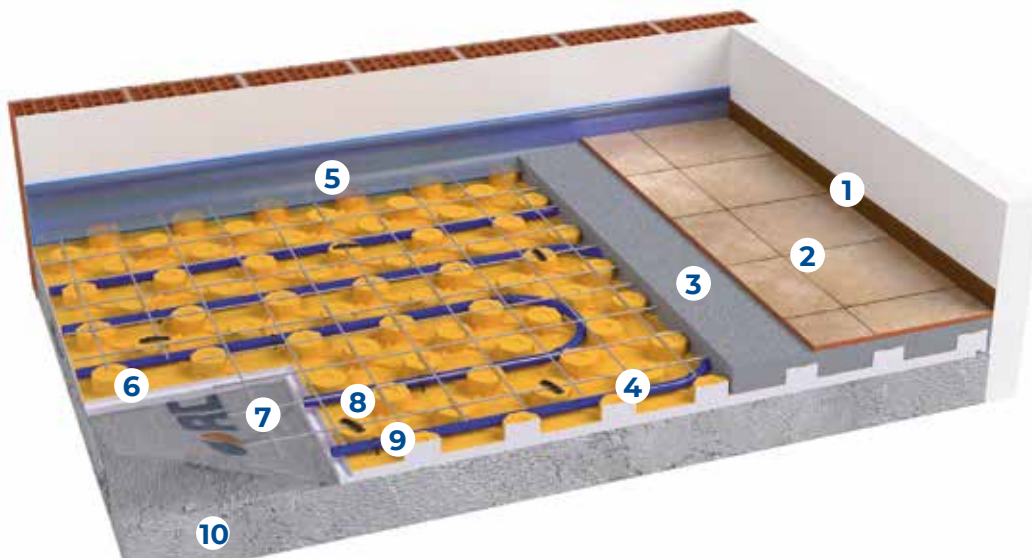

- 1 Skirting board
- 2 Flooring
- 3 Concrete
- 4 RDZ Tech pipe Ø 17-13
- 5 Plus perimeter belt
- 6 Cover panel
- 7 Anti-shrinkage mesh
- 8 Clip 75
- 9 Hooked clip
- 10 Substrate + levelling

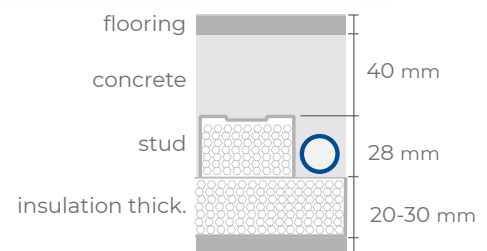

Indicative quotas

Panel thickness	20 mm	30 mm
Quote with Tiles - Parquet flooring	10 - 11 cm	11 - 12 cm
Quote with Marble - Blockboard flooring	11 - 13 cm	12 - 14 cm

Installation notes

- If the floor is in direct contact with the ground (i.e. without a sanitary void or insulating sheathing), provide a polyethylene sheet to act as a moisture barrier.
- Check that the site is clear and clean
- Check the dimensions available, taking into consideration the thickness of the insulation, screed and flooring chosen.
- Lay the perimeter belt and the insulation panels
- Lay the pipes as stated the project
- Usually, it's not necessary to bend the pipe with a bending radius of less than 12.5 cm, i.e. with a laying pitch of less than 25 cm
- Test the system and leave it under pressure until all subsequent works are completed
- If necessary, install the anti-shrinkage mesh

Note: Please refer to the installation manual for more information.

PRODUCTS THAT COMPOSE THE SYSTEM

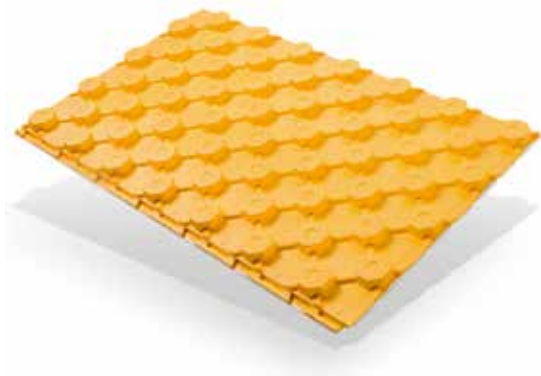

Cover Panel

Cover panel with studs made of waterproof moulded expanded polystyrene, produced in conformity with UNI EN 13163, with closed-cell structure, which has high compression strength. They have a moulded surface with studs of 28 mm so that the pipes can be fitted into the tabs of the panel at spacing of 8.3 cm or multiples.

SIZE	THICKNESS	CODE
1161x663 mm	20 mm	1056020
1161x663 mm	30 mm	1056030

Panel features	Symbol	20	30	Unit	Standard
Necessary Length	L1	1161		mm	UNI EN 822
Necessary Width	W1	663		mm	UNI EN 822
Total Thickness	T4	48	58	mm	UNI EN 823
Insulation base thickness		20	30	mm	
Equivalent thickness		28.96	38.97	mm	UNI EN 1264/3
Compressive stress at 10% deformation	CS(10)	120		kPa	UNI EN 826
Thermal conductivity at 10 °C	λ_D	0.035		W/(m·K)	UNI EN 13163
Thermal resistance equivalent thickness	R_D	0.80	1.10	(m ² ·K)/W	EN 1264-3 2009
Thermal resistance base thickness	R_D	0.55	0.85	(m ² ·K)/W	FprEN 1264:2020
Water vapour diffusion resistance factor	μ (MU)	30 ÷70			UNI EN 12086
Dimension stability 48h / 70°C	DS(70,-)	≤ 0.5		%	UNI EN 1604
Reaction to fire class		F		Euroclass	UNI EN 13501-1
Long term water absorption by partial immersion	Wlp	0.5		kg/m ²	UNI EN 12087
Long-term water absorption by total immersion	WL(T)	≤ 3		%	UNI EN 12087
Limit of operating temperature		70		°C	
Specific heat	C	1450		J/kg·°k	UNI EN 10456
HIPS Foil thickness		150		µm	
Declaration according to UNI EN 13163					
Unique identification code of the product-type: EPS-EN 13163-T2-L3-W3-S2-P5-BS 170-CS(10)120-DS(70,-)1-WL(T)3-MU(30-70)					

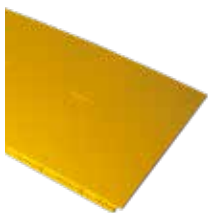

Cover Smooth Panel

Cover smooth panel made of waterproof moulded expanded polystyrene, produced in conformity with UNI EN 13163, with closed-cell structure. This panel is combined with a special plastic film in order to protect it from humidity in compliance with EN 1264.

SIZE	THICKNESS	CODE
1161x663 mm	20 mm	1056120
1161x663 mm	30 mm	1056130



RDZ Tech PE-Xa Pipe Ø 17 Interior Layer

RDZ Tech PE-Xa pipe Ø 17-13 made of high-density cross-linked polyethylene with the oxygen barrier between the PE-X layer and an outer layer made of PE, which ensures further protection during installation in the building site. The layers are combined thanks to a special glue.

TYPE	ROLL	CODE
PE-Xa	240 m	1013840
PE-Xa	600 m	1013850

Note: for further technical data see page 176



Plus perimeter belt

Plus perimeter belt is the edge insulation, which absorbs floor expansions and acts as thermo-acoustic insulation for the walls.

SIZE	CODE
5x150 mm	1071250



Hooked clip

Hooked clips made of plastic material to ensure secure positioning of the pipe on the insulating panels.

PACKAGE	CODE
100 pieces	1017000



Open Elbow

Open elbow Ø 17 made of plastic material. It is used to support the pipes near the manifolds vertically and to protect them from any damage.

SIZE	CODE
Ø 17 mm	1130517



Thermofluidifying Additive 4S

Superfluxing, multidosage, water reducing admixture for concrete to increase its workability and to improve its mechanical properties and thermal conductivity. It is a product which conforms to EN 934-2; T3.1 - 3.2.

SIZE	CODE
10 liters	1091911
20 liters	1091921

Tips for material calculation

Needed products	Requirements
Cover panel	Area to be covered +3%
Smooth COVER panel	1 pack per manifold
RDZ Tech pipe Ø 17 mm	Depending on the average pitch. Total = surface area / pitch [m ² /m]
Plus perimeter belt	1 metre per m ²
Open elbow Ø 17	2 for each circuit
Hooked clip	5 for each circuit
Thermofluidifying Additive 4S	Approx. 0.2 litres per m ²

Optional products	Requirements
Fibreglass Mesh	Area to be covered +10%
RDZ Fiber (polypropylene fibres)	1 kg per 16 m ²
Clip 75	To be used only if anti-shrinkage mesh is used. 5 clips/m ²
Humidity Barrier Sheet	Area to be covered +20%
Inibitor XR20	2% of ENTIRE water content
Biocide XR40	1% of ENTIRE water content

Manifolds, heads, accessories and optional products (from page 162).

Note: The requirements in the table are indicative. Please refer to the construction project for confirmation..

THERMAL OUTPUT OF THE SYSTEM

Thermal output in heating

Input data			
Screed coverings above the pipe	s_U	0.045	m
Heat conductivity of screed	λ_E	1.2	W(m·k)
Piper external diameter	d_o	0.017	m
Pipe wall thickness	s_R	0.002	m
Pipe heat conductivity	λ_R	0.35	W(m·k)

K_H																
$R_{\lambda,B} [m^2 \cdot k/W]$																
T cm	0.00	0.01	0.02	0.03	0.04	0.05	0.06	0.07	0.08	0.09	0.10	0.11	0.12	0.13	0.14	0.15
8.3	6.555	6.110	5.723	5.382	5.081	4.812	4.570	4.352	4.154	3.973	3.808	3.656	3.516	3.386	3.265	3.153
16.6	5.144	4.833	4.564	4.328	4.119	3.933	3.759	3.602	3.460	3.331	3.213	3.099	2.993	2.896	2.806	2.722
24.9	4.066	3.850	3.662	3.499	3.356	3.230	3.105	2.993	2.893	2.802	2.719	2.633	2.555	2.482	2.415	2.353

$R_{\lambda,B}$: Heat conduction resistance of the floor covering
 T: Pipe spacing

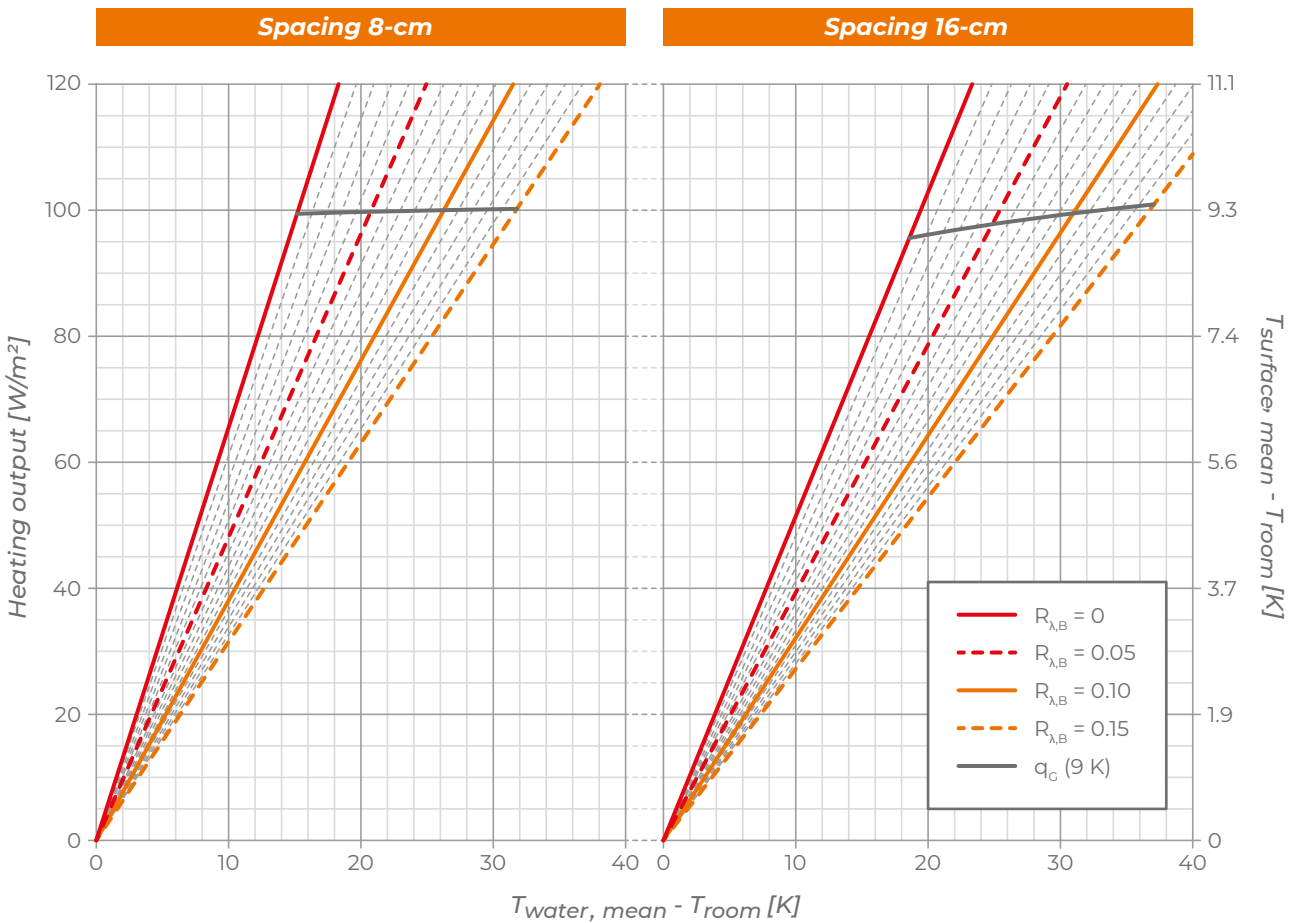

Thermal output in cooling

Input data			
Screed coverings above the pipe	s_U	0.045	m
Heat conductivity of screed	λ_E	1.2	W(m·k)
Piper external diameter	d_o	0.017	m
Pipe wall thickness	s_R	0.002	m
Pipe heat conductivity	λ_R	0.35	W(m·k)

K_H																
$R_{\lambda,B} [m^2 \cdot k / W]$																
T cm	0.00	0.01	0.02	0.03	0.04	0.05	0.06	0.07	0.08	0.09	0.10	0.11	0.12	0.13	0.14	0.15
8.3	4.550	4.334	4.137	3.958	3.793	3.641	3.502	3.372	3.252	3.140	3.035	2.937	2.846	2.760	2.678	2.602
16.6	3.773	3.616	3.471	3.338	3.214	3.099	2.992	2.892	2.799	2.712	2.629	2.552	2.479	2.410	2.345	2.283
24.9	3.134	3.021	2.916	2.818	2.726	2.640	2.560	2.484	2.412	2.345	2.281	2.221	2.163	2.109	2.057	2.008

$R_{\lambda,B}$: Heat conduction resistance of the floor covering
 T: Pipe spacing

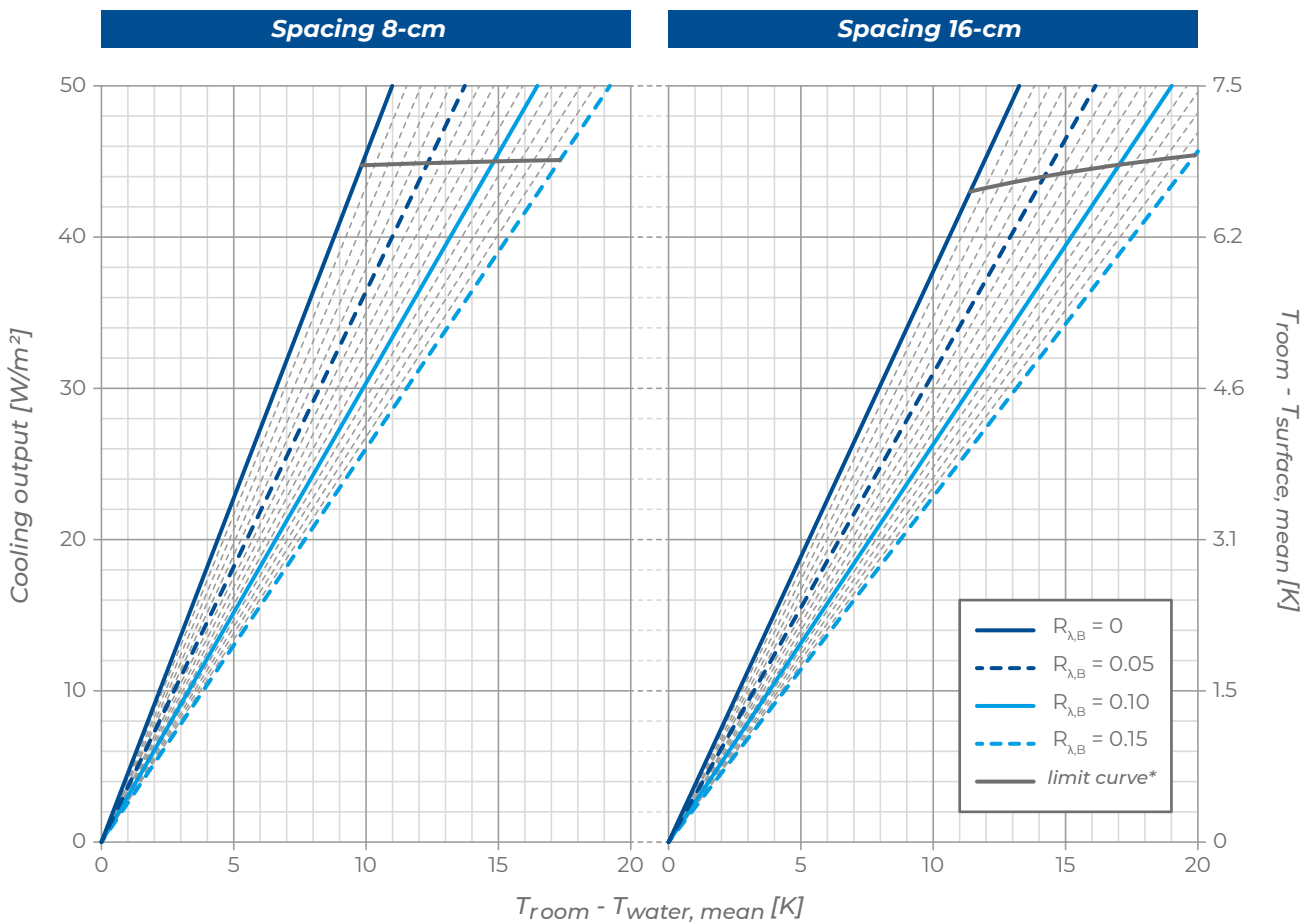

*valid only for room temperature = 26 °C



Acoustic Plus is a traditional underfloor radiant heating and cooling system, characterised by pipe anchored to an insulated base and embedded in the screed.

Ideal for applications where it is necessary to maintain a constant ambient temperature throughout the day, it can be used in both the residential and commercial applications, particularly in buildings where the reduction of trample noise is a particularly important requirement.

The central element of the system is the Acoustic Plus studded panel made of two layers of expanded sintered polystyrene with different densities and excellent acoustic performances. The materials used and the production technology guarantee a reduction in the impact sound level of 29 dB for the 20 mm thick panel and 26 dB for the 30 mm thick panel.

The system is completed by RDZ Tech PE-X Ø 17 mm high density cross-linked polyethylene pipe and equipped with anti-oxygen barrier according to DIN 4726, the hooked clips, the open support elbows, the manifold, the Plus perimeter belt and the 4S thermo-fluidifying additive.

FEATURES

- Reduces trample noise within legal limits
- RDZ Tech pipe Ø 17 mm
- High mechanical resistance
- Suitable for residential and commercial applications
- Easy and quick installation



SECTION AND DIMENSIONS

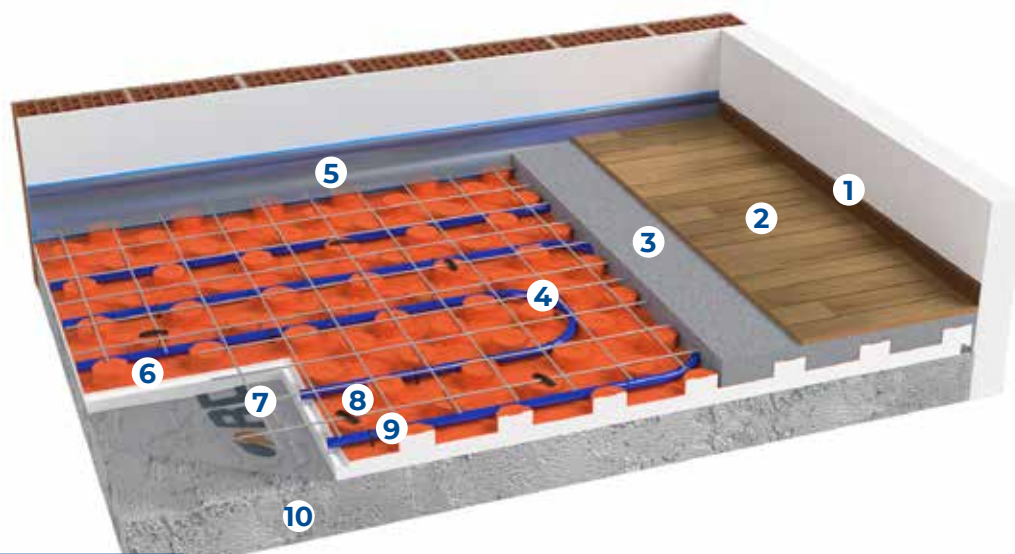

- 1 Skirting board
- 2 Flooring
- 3 Concrete
- 4 RDZ Tech pipe Ø 17-13
- 5 Plus perimeter belt
- 6 Acoustic Plus panel
- 7 Anti-shrinkage mesh
- 8 Clip 75
- 9 Hooked clip
- 10 Substrate + levelling

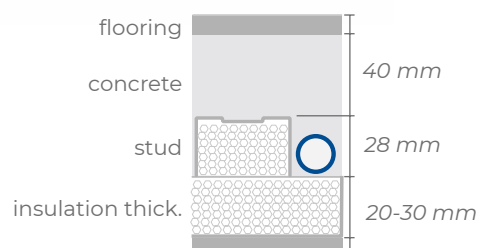

Indicative quotas

Panel thickness	20 mm	30 mm
Quote with Tiles - Parquet flooring	10 - 11 cm	11 - 12 cm
Quote with Marble - Blockboard flooring	11 - 13 cm	12 - 14 cm

Installation notes

- If the floor is in direct contact with the ground (i.e. without a sanitary void or insulating sheathing), provide a polyethylene sheet to act as a moisture barrier
- Check that the site is clear and clean.
- Ensure that the laying surface is free of protrusions that could interrupt the continuity of the insulation layer
- Check the dimensions available, taking into account the thickness of the insulation, the thickness of the screed and the thickness of the flooring chosen.
- Lay the perimeter frame and the insulation panels
- Lay the pipework as stated the project
- As a general rule, it is never necessary to bend the pipe with a bending radius of less than 12.5 cm, i.e. with a bend of less than 25°.
- Test the system and leave it under pressure until all further work has been completed.
- If necessary, install the anti-shrinkage mesh

Note: Please refer to the installation manual for more information.

PRODUCTS THAT COMPOSE THE SYSTEM



ACOUSTIC PLUS Panel

Acoustic Plus panel with studs made of stretch, expanded, sintered polystyrene with double density, ideal for thermal and acoustic insulation. Acoustic Plus panel is combined with a special plastic film, thickness 0.15 mm, which protects it from humidity (in compliance with EN 1264). Trample noise reduction of ΔL_w 29 dB (according to UNI EN 12354-2), dynamic rigidity $SD \leq 15 \text{ MN/m}^3$. These panels have a tongue along the perimeter to connect them for proper combination, and they have a moulded surface with studs of 28 mm, so that the pipes can be fitted into the tabs of the panel with spacing of 8.3 cm or multiples

Features

SIZE	THICKNESS	CODE
1161x663 mm	20 mm	1054040
1161x663 mm	30 mm	1054050

Panel features	Symbol	20	30	Unit	Standard
Necessary Length	L1	1161		mm	UNI EN 822
Necessary Width	W1	663		mm	UNI EN 822
Total Thickness	T4	48	58	mm	UNI EN 823
Insulation base thickness		20	30	mm	
Equivalent thickness		30.5	40.5	mm	UNI EN 1264/3
Compressibility	CP3	≤ 3		mm	UNI EN 12431
Max load on the surface		≤ 4		kPa	UNI EN 1191-2-1
Thermal conductivity at 10 °C	λ_D	0.037		W/(m·K)	UNI EN 13163
Thermal resistance calculated on the equivalent thick.	R_D	0.80	1.05	(m ² ·K)/W	EN 1264-3 2009
Thermal resistance base thickness	R_D	0.50	0.80	(m ² ·K)/W	FprEN 1264:2020
Dynamic stiffness SD	SD	≤ 15	≤ 20	mN/m ³	EN 29052-1
Footstep sound absorption	ΔL_w	29*	26	dB	UNI EN ISO 140-8
Water vapour resistance factor	μ (MU)	40 ÷ 100			UNI EN 12086
Water vapour transmission	δ	0.006 ÷ 0.015		mg/(Pa·h·m)	UNI EN 12086
Dimension stability 48h / 70°C	DS(70,-)	1		%	UNI EN 1604
Reaction to fire class		F		Euroclass	UNI EN 13501-1
Long term water absorption by partial immersion	Wlp	≤ 0.5		kg/m ²	UNI EN 12087
Long-term water absorption by total immersion	WL(T)	≤ 3		%	UNI EN 12087
Limit of operating temperature		70		°C	
Weight		660	760	g	
Specific heat	C	1450		J/kg·°k	UNI EN 10456
HIPS Foil thickness		140 ÷ 150		μm	
*: according to UNI EN 12354-2 with floating floors of 80 kg/m ²					
Declaration according to UNI EN 13163					
20 mm - Class: EPS T, Identification code: EPS T-EN 13163-T0-L3-W3-S2-P5-DS(70,-)1-WL(T)3-SD15-CP3-MU(40÷100)					
30 mm - Class: EPS T, Identification code: EPS T-EN 13163-T0-L3-W3-S2-P5-DS(70,-)1-WL(T)3-SD20-CP3-MU(40÷100)					



RDZ Tech PE-Xa Pipe Ø 17 Interior Layer

RDZ Tech PE-Xa pipe Ø 17-13 made of high-density cross-linked polyethylene with the oxygen barrier between the PE-X layer and an outer layer made of PE, which ensures further protection during installation in the building site. The layers are combined thanks to a special glue.

TYPE	ROLL	CODE
PE-Xa	240 m	1013840
PE-Xa	600 m	1013850

Note: for further technical data see page 176



Plus perimeter belt

Plus perimeter belt is the edge insulation, which absorbs floor expansions and acts as thermo-acoustic insulation for the walls.

SIZE	CODE
5x150 mm	1071250



Hooked clip

Hooked clips made of plastic material to ensure secure positioning of the pipe on the insulating panels.

PACKAGE	CODE
100 pieces	1017000



Open Elbow

Open elbow Ø 17 made of plastic material. It is used to support the pipes near the manifolds vertically and to protect them from any damage.

SIZE	CODE
Ø 17 mm	1130517



Thermofluidifying Additive 4S

Superfluxing, multidosage, water reducing admixture for concrete to increase its workability and to improve its mechanical properties and thermal conductivity. It is a product which conforms to EN 934-2; T3.1 - 3.2.

SIZE	CODE
10 liters	1091911
20 liters	1091921

Tips for material calculation

Needed products	Requirements
Acoustic Plus Panel	Area to be covered +3%
RDZ Tech pipe Ø 17 mm	Depending on the average pitch. Total = area / pitch [m ² /m]
Plus perimeter belt	1 metre per m ²
Open elbow Ø 17	2 for each circuit
Hooked clip	5 for each circuit

Optional products	Requirements
Fibreglass Mesh	Area to be covered +10%
RDZ Fiber (polypropylene fibres)	1 kg per 16 m ²
Clip 75	To be used only if anti-shrinkage mesh is used. 5 clips/m ²
Humidity Barrier Sheet	Surface to be covered +20%
Thermofluidifying Additive 4S	Approx. 0.2 litres per m ²
Inhibitor XR20	2% of ENTIRE water content
Biocide XR40	1% of ENTIRE water content

Manifolds, heads, accessories and optional products (from page 162).

Note: The requirements in the table are indicative. Please refer to the construction project for confirmation..

THERMAL OUTPUT OF THE SYSTEM

Thermal output in heating

Input data			
Screed coverings above the pipe	s_U	0.045	m
Heat conductivity of screed	λ_E	1.2	W(m·k)
Piper external diameter	d_o	0.017	m
Pipe wall thickness	s_R	0.002	m
Pipe heat conductivity	λ_R	0.35	W(m·k)

K_H																
$R_{\lambda,B} [m^2 \cdot k/W]$																
T cm	0.00	0.01	0.02	0.03	0.04	0.05	0.06	0.07	0.08	0.09	0.10	0.11	0.12	0.13	0.14	0.15
8.3	6.556	6.111	5.723	5.383	5.081	4.812	4.571	4.352	4.154	3.974	3.809	3.656	3.516	3.386	3.266	3.154
16.6	5.144	4.834	4.565	4.328	4.119	3.934	3.760	3.603	3.461	3.331	3.213	3.099	2.994	2.896	2.806	2.722
24.9	4.067	3.850	3.663	3.500	3.356	3.230	3.105	2.994	2.893	2.802	2.719	2.634	2.555	2.482	2.415	2.353

$R_{\lambda,B}$: Heat conduction resistance of the floor covering
 T: Pipe spacing

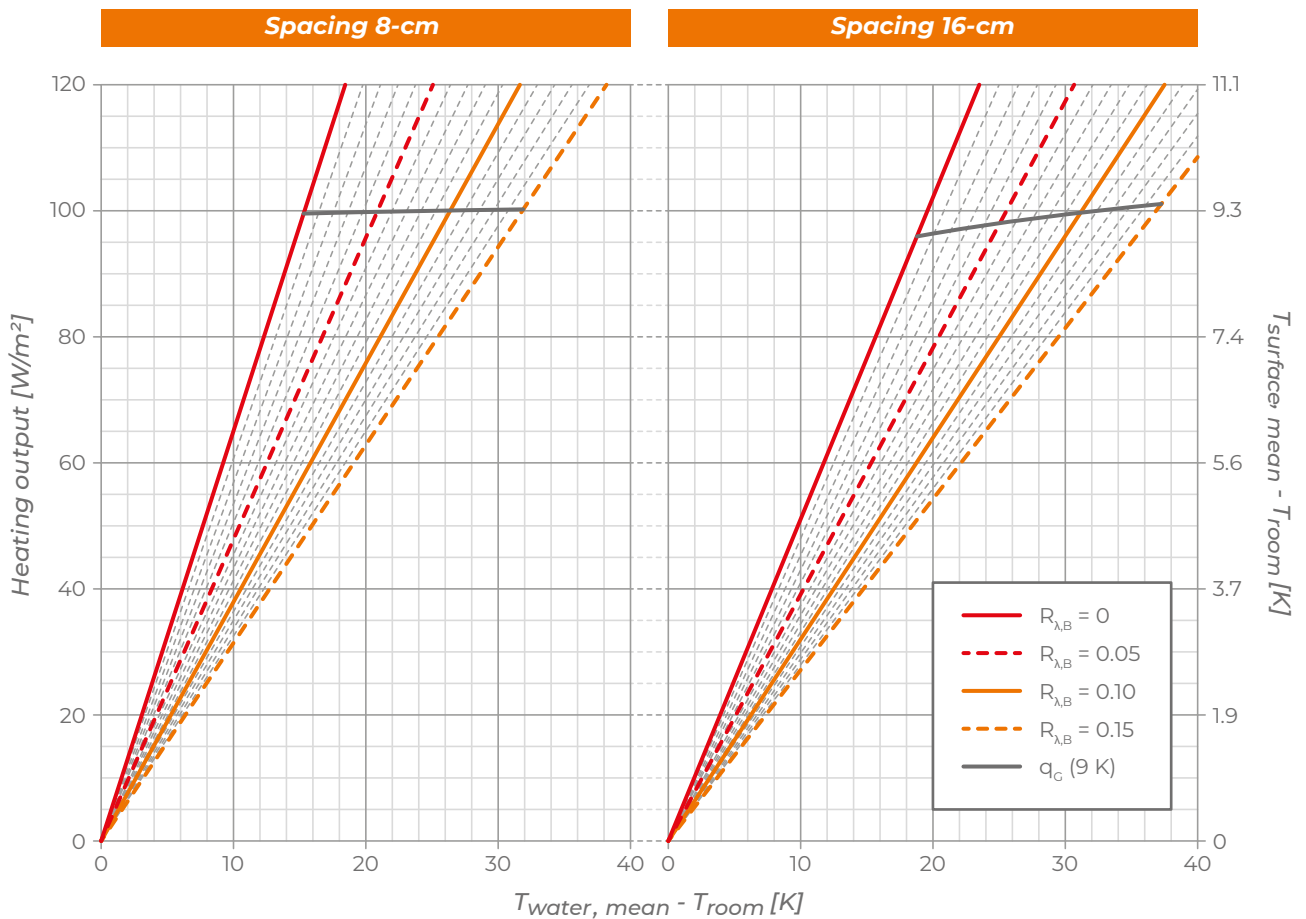

Thermal output in cooling

Input data			
Screed coverings above the pipe	s_U	0.045	m
Heat conductivity of screed	λ_E	1.2	W(m·k)
Piper external diameter	d_o	0.017	m
Pipe wall thickness	s_R	0.002	m
Pipe heat conductivity	λ_R	0.35	W(m·k)

K_H																
$R_{\lambda,B} [m^2 \cdot k / W]$																
T cm	0.00	0.01	0.02	0.03	0.04	0.05	0.06	0.07	0.08	0.09	0.10	0.11	0.12	0.13	0.14	0.15
8.3	4.551	4.334	4.138	3.958	3.793	3.642	3.502	3.372	3.252	3.140	3.035	2.938	2.846	2.760	2.679	2.602
16.6	3.774	3.616	3.471	3.338	3.214	3.099	2.992	2.893	2.799	2.712	2.630	2.552	2.479	2.410	2.345	2.283
24.9	3.135	3.022	2.916	2.818	2.727	2.641	2.560	2.484	2.413	2.345	2.281	2.221	2.163	2.109	2.057	2.008

$R_{\lambda,B}$: Heat conduction resistance of the floor covering
 T: Pipe spacing

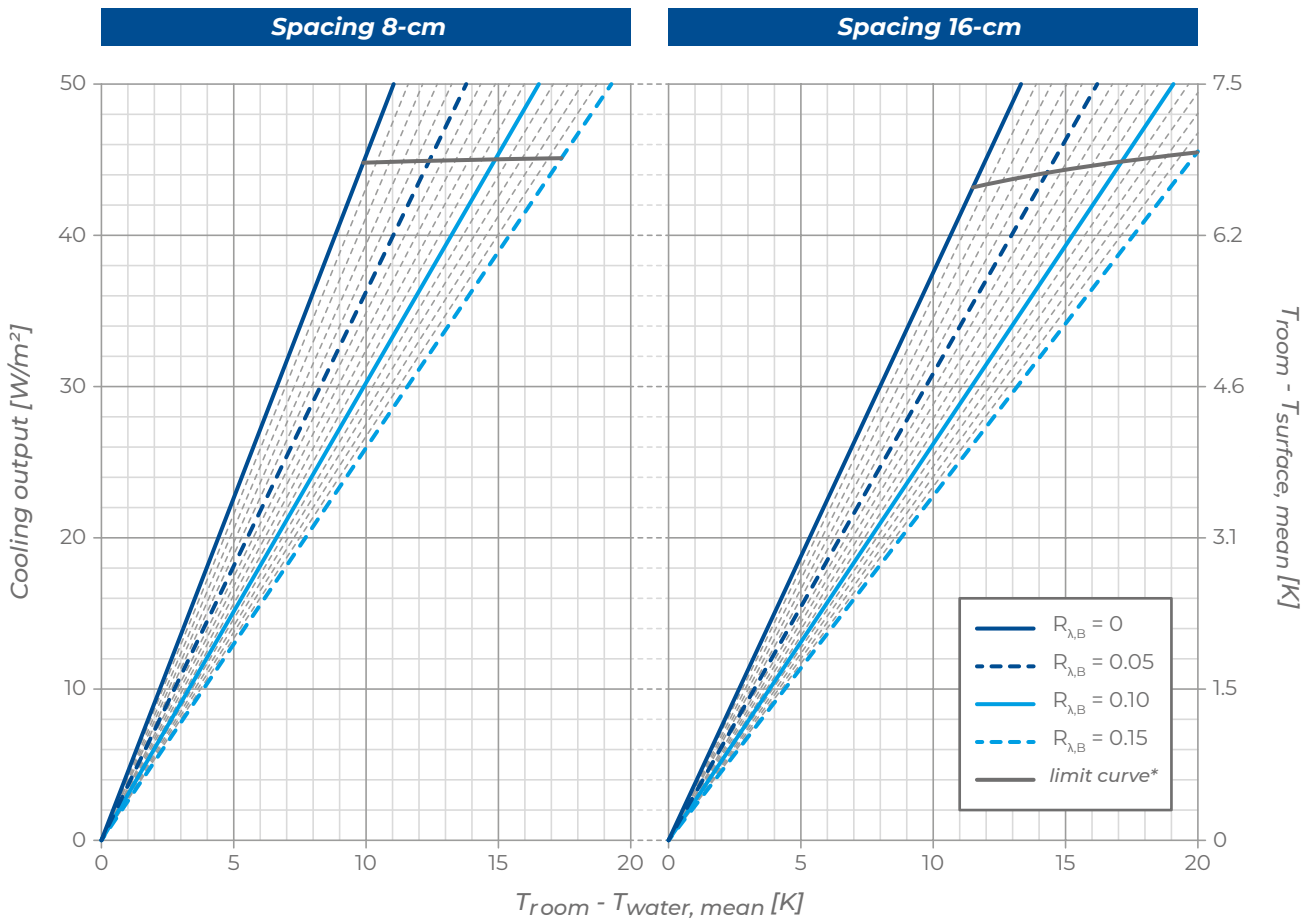

*valid only for room temperature = 26 °C



AcuRapid is an underfloor radiant heating and cooling system, characterised by excellent acoustic properties and quick and easy installation.

The central element of the system is the AcuRapid B panel made of EPS T elasticised sintered expanded polystyrene, covered with a special screen-printed fabric to facilitate the installation of the Rapid PE-RT pipe Ø 17 mm.

Available in the 20 and 30 mm versions, it has elastic properties that make it possible to obtain average sound reduction of 26 and 28 dB(A) with a screed of 100 kg/m², according to UNI EN 12354-2.

The installation of AcuRapid is quick and easy thanks to the tear-off connection system: the pipe is wrapped in a band with tiny hooks arranged in a helical pattern that adheres firmly to the panel without the need for additional fastening components.

The system is completed with the Plus perimeter belt, the manifold, the open support elbows and the 4S thermofluidifying additive.

FEATURES

- Tear-off fastening of Rapid PE-RT pipe Ø 17 mm
- Very good acoustic performances
- Suitable for residential and commercial applications
- Quick and easy to install



SECTION AND DIMENSIONS

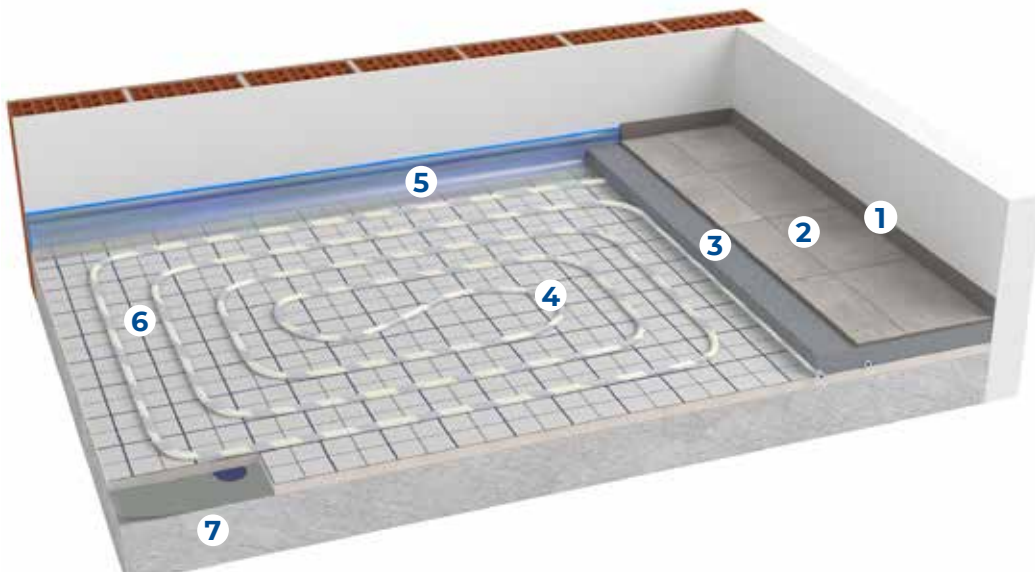

- 1 Skirting board
- 2 Flooring
- 3 Concrete
- 4 Rapid PE-RT pipe Ø 17-13
- 5 Plus perimeter belt
- 6 Acurapid B panel
- 7 Substrate + levelling

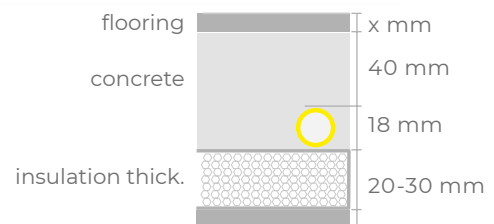

Indicative quotas

Panel thickness	20 mm	30 mm
Quote with Tiles - Parquet flooring	9 - 10 cm	10 - 11 cm
Quote with Marble - Blockboard flooring	10 - 11 cm	11 - 12 cm

Installation notes

- If the floor is in direct contact with the ground (i.e. without a sanitary void or insulating sheathing), provide a polyethylene sheet to act as a moisture barrier
- Check that the site is clear
- Check the available dimensions, taking into consideration the thickness of the insulation, screed and flooring chosen.
- Lay the perimeter belt and the insulation panels
- Lay the pipe as stated in the project
- Usually, it's not necessary to bend the pipe with a bending radius of less than 12.5 cm, i.e. with a laying pitch of less than 25 cm
- Test the system and leave it under pressure until all subsequent works are completed

Note: Please refer to the installation manual for more information.

PRODUCTS THAT COMPOSE THE SYSTEM

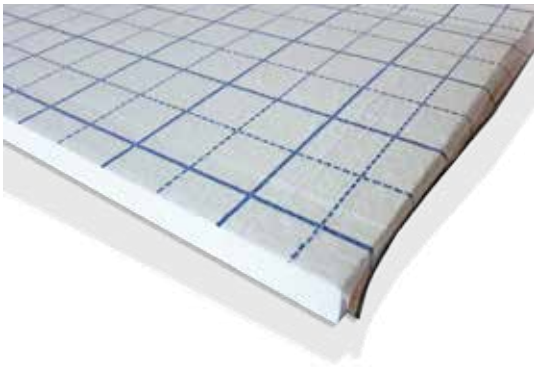

AcuRapid B Panel

Smooth panels in rolls made of ESP T CP2 elastic expanded sintered polystyrene. It is covered with a special protective film barrier which is suitable for attaching the pipe thanks to its hook fastening tape. The foil overlaps on two sides, therefore the foil layer is continuous.

SIZE	THICKNESS	CODE
1x10 m	20 mm	1045442
1x10 m	30 mm	1045552

Panel features	Level/ Class	Code		Unit	Standard
		1045442	1045552		
Necessary length	L(3)	10000 (± 3)		mm	UNI EN 13163:2015
Necessary width	W(3)	1000 (± 3)			
Total thickness	T(2)	20 (-1, +3)	30 (-1, +3)		
Insulation base thickness		20 (-1, +3)	30 (-1, +3)		
Equivalent thickness		20 (-1, +3)	30 (-1, +3)		
Compressibility	CP2	≤ 2		Kpa	
Maximum applicable load on the surface		≤ 5			
Thermal conductivity at 10 °C		λ_D 0.040		W/(m·K)	
Thermal resistance calculated on the equivalent thickness		R _D 0.50	R _D 0.75	(m ² ·K)/W	
Dynamic stiffness		≤ 30	≤ 20	mN/m ³	
Dimensional stability 23 °C / 50 % U.R.		± 0.5		%	
Water absorption by total immersion		≤ 5		%	
Durability of reaction to fire performance against aging/degradation	The reaction to fire performance for EPS does not reduce over time.				
Durability of thermal resistance against aging/degradation	The thermal conductivity of EPS does not change over time.				
Reaction to fire class	Euroclass E				
Maximum operating temperature		70		°C	
Sound absorption (with 100 Kg/m ² screed)		-	25	dB(A)	EN 12354-2
Unique identification code of the product-type					
Thickness 20 mm: EPS-EN 13163:2015-L3-W3-T1-S2-P5-DS(N)2-BS050-SD30-CP2-MU(20-40)					
Thickness 30 mm: EPS-EN 13163:2015-L3-W3-T1-S2-P5-DS(N)2-BS050-SD20-CP2-MU(20-40)					



Rapid PE-RT Pipe Ø 17

RDZ 17-13 polyethylene pipe with EVOH oxygen diffusion barrier which complies with DIN 4726. It consists in 5 layers PE-RT/EVOH/PE-RT ensuring outstanding flexibility & easy handling. A micro-interlocking band is helically wound around the pipe.

SIZE	TYPE	CODE
Ø 17-13 mm	PE-RT	1013890



Plus perimeter belt

Plus perimeter belt is the edge insulation, which absorbs floor expansions and acts as thermo-acoustic insulation for the walls.

SIZE	CODE
5x150 mm	1071250



Open Elbow

Open elbow Ø 17 made of plastic material. It is used to support the pipes near the manifolds vertically and to protect them from any damage.

SIZE	CODE
Ø 17 mm	1130517



Thermofluidifying Additive 4S

Superfluxing, multidosage, water reducing admixture for concrete to increase its workability and to improve its mechanical properties and thermal conductivity. It is a product which conforms to EN 934-2; T3.1 - 3.2.

SIZE	CODE
10 liters	1091911
20 liters	1091921

Tips for material calculation

Needed products	Requirements
AcuRapid B Panel	Area to be covered +5%
Rapid Pe-RT pipe Ø 17 mm	Depending on the average pitch. Total = area / pitch [m ² /m]
Plus perimeter belt	1 metre per m ²
Open elbow Ø 17	2 for each circuit

Optional products	Requirements
RDZ Fiber (polypropylene fibres)	1 kg per 16 m ²
Humidity Barrier Sheet	Area to be covered +20%
Thermofluidifying Additive 4S	Approx. 0.2 litres per m ²
Inhibitor XR20	2% of ENTIRE water content
Biocide XR40	1% of ENTIRE water content

Manifolds, heads, accessories and optional products (from page 162).

Note: The requirements in the table are indicative. Please refer to the construction project for confirmation

THERMAL OUTPUT OF THE SYSTEM

Thermal output in heating

Input data			
Screed coverings above the pipe	s_U	0.045	m
Heat conductivity of screed	λ_E	1.2	W(m·k)
Piper external diameter	d_o	0.017	m
Pipe wall thickness	s_R	0.002	m
Pipe heat conductivity	λ_R	0.40	W(m·k)

K_H																
$R_{\lambda,B} [m^2 \cdot k/W]$																
T cm	0.00	0.01	0.02	0.03	0.04	0.05	0.06	0.07	0.08	0.09	0.10	0.11	0.12	0.13	0.14	0.15
8.3	6.811	6.332	5.917	5.554	5.233	4.948	4.693	4.463	4.255	4.066	3.893	3.734	3.587	3.452	3.327	3.211
16.6	5.345	5.009	4.719	4.466	4.243	4.045	3.860	3.694	3.544	3.408	3.284	3.165	3.054	2.953	2.859	2.772
24.9	4.225	3.990	3.787	3.611	3.457	3.321	3.188	3.070	2.963	2.867	2.779	2.689	2.607	2.531	2.461	2.396

$R_{\lambda,B}$: Heat conduction resistance of the floor covering
 T: Pipe spacing

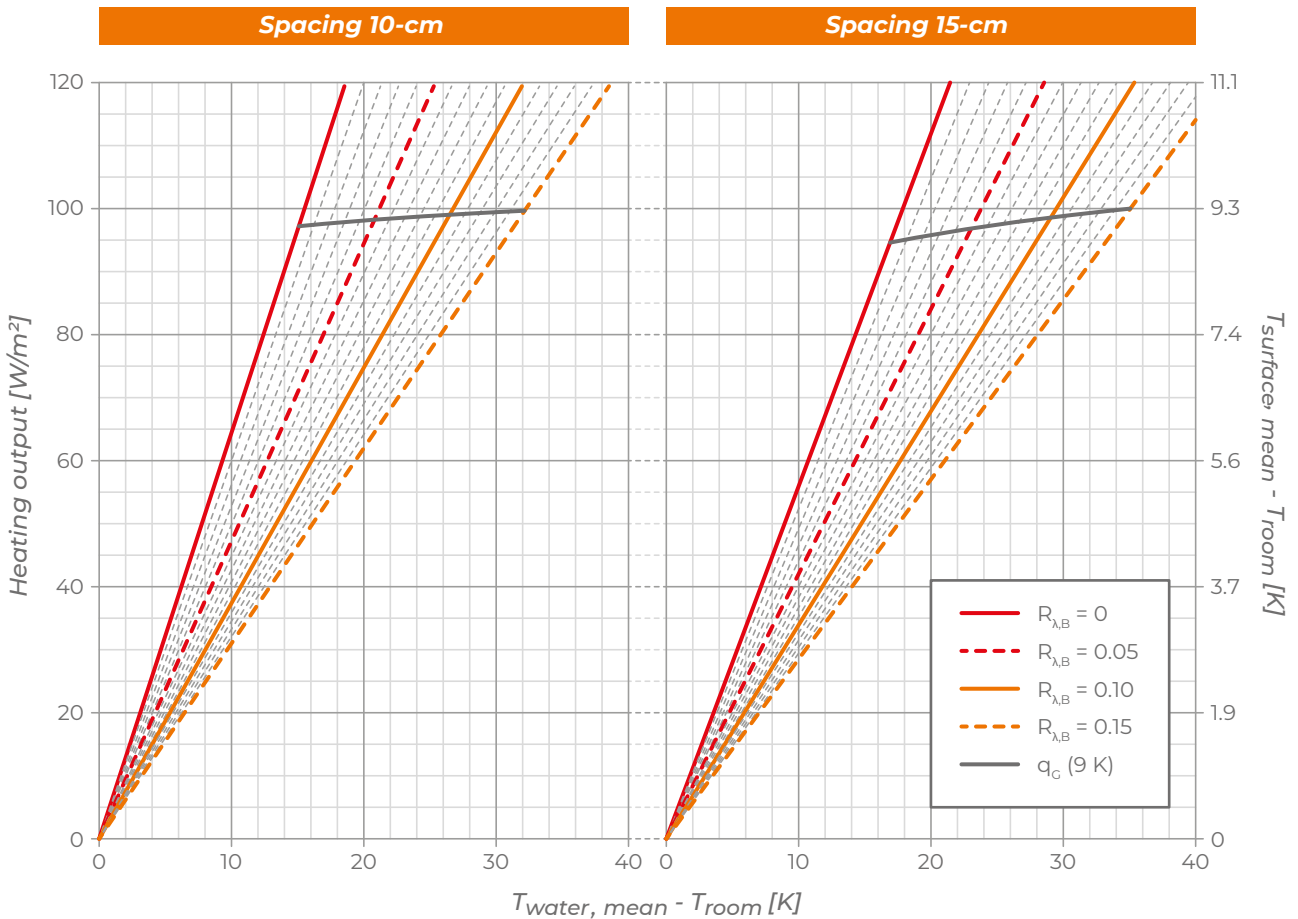

Thermal output in cooling

Input data			
Screed coverings above the pipe	s_U	0.045	m
Heat conductivity of screed	λ_E	1.2	W(m·k)
Piper external diameter	d_o	0.017	m
Pipe wall thickness	s_R	0.002	m
Pipe heat conductivity	λ_R	0.40	W(m·k)

K_H																
$R_{\lambda,B} [m^2 \cdot k/W]$																
T cm	0.00	0.01	0.02	0.03	0.04	0.05	0.06	0.07	0.08	0.09	0.10	0.11	0.12	0.13	0.14	0.15
8.3	4.672	4.444	4.237	4.049	3.877	3.718	3.573	3.438	3.313	3.197	3.088	2.987	2.892	2.803	2.720	2.641
16.6	3.876	3.709	3.557	3.416	3.286	3.165	3.054	2.949	2.852	2.761	2.675	2.595	2.519	2.448	2.380	2.316
24.9	3.221	3.101	2.989	2.885	2.788	2.698	2.613	2.533	2.458	2.387	2.321	2.258	2.198	2.141	2.087	2.036

$R_{\lambda,B}$: Heat conduction resistance of the floor covering
 T: Pipe spacing

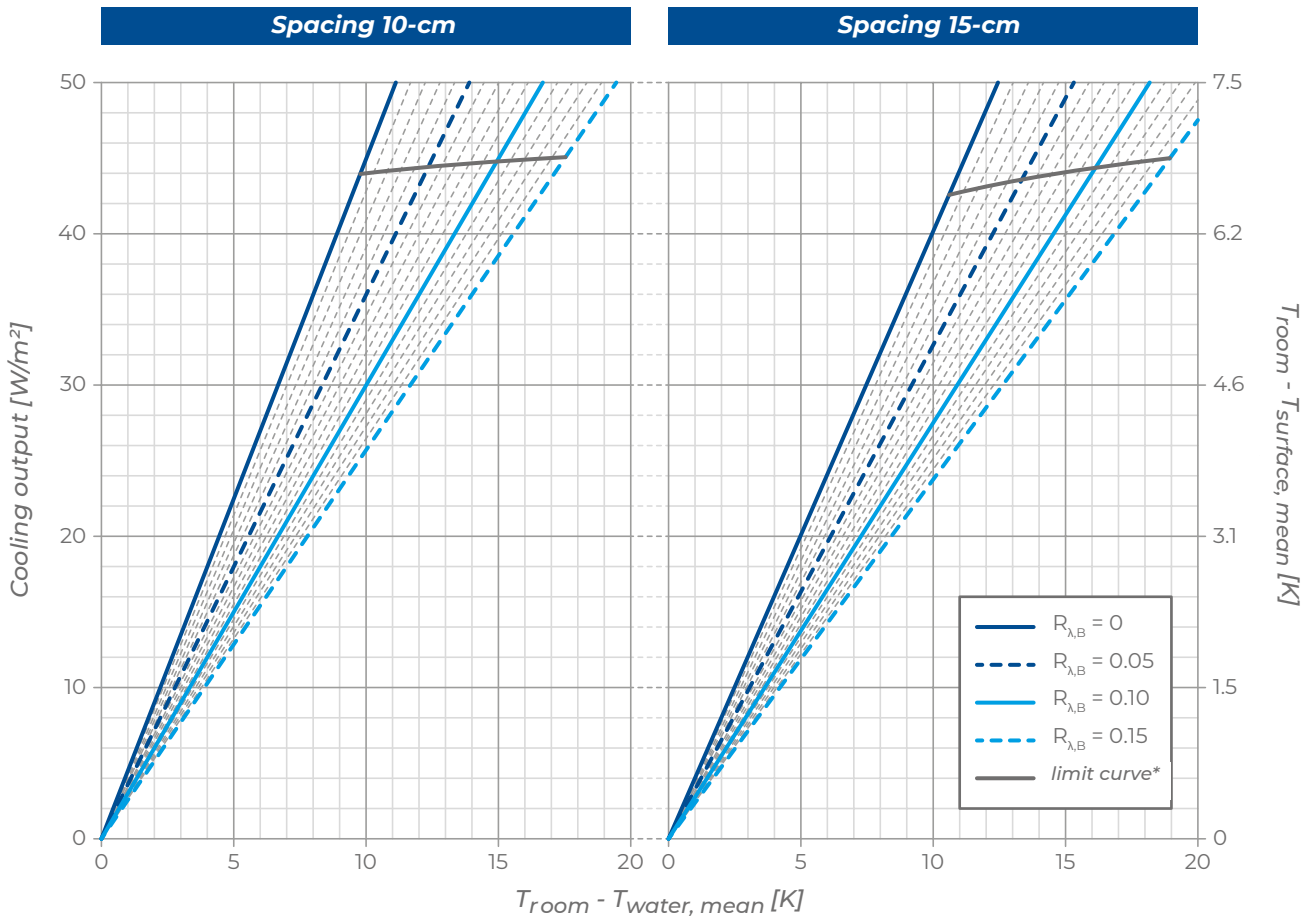

*valid only for room temperature = 26 °C

SMOOTH COVER HP SYSTEM



Smooth Cover HP is a traditional underfloor radiant heating and cooling system, characterised by pipes anchored to an insulated base by special fixing clips and embedded in the screed.

Invisible and efficient, it can be used in both residential and commercial applications and it is ideal for applications where it is necessary to maintain a constant room temperature throughout the day.

The central element of the system is the Smooth Cover HP panel made of sintered polystyrene with graphite compliant with UNI EN 13163, with high mechanical resistance and characterised by special grooves on the surface that facilitate the laying of the pipe.

Available in a wide range of thicknesses (24, 39, 47 and 62 mm), it satisfies a variety of requirements and, thanks to the presence of graphite, offers excellent thermal insulation performance even with reduced overall dimensions.

The system is completed by RDZ Tech pipe in PE-X Ø 17 or 20 mm, in high-density cross-linked polyethylene and provided with anti-oxygen barrier according to DIN 4726, the clips for anchoring the pipe to be applied by a special clip fastener, the support curves, the manifold, the Plus perimeter belt and the 4S thermo-fluidifying additive.

FEATURES

- Smooth panel in sintered polystyrene with graphite
- RDZ Tech pipe Ø 17 mm and Ø 20 mm
- Excellent thermal insulation
- Available in thicknesses 24-39-47-62 mm
- Suitable for residential and commercial applications
- Easy and quick installation



SECTION AND DIMENSIONS

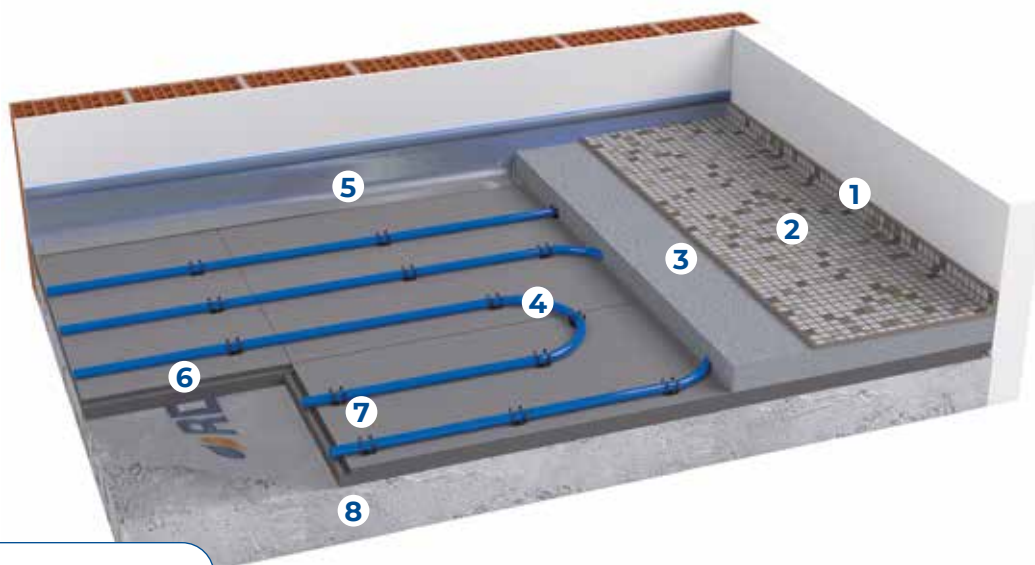

- 1 Skirting board
- 2 Flooring
- 3 Concrete
- 4 RDZ Tech pipe Ø 17-13
- 5 Plus perimeter belt
- 6 Smooth Cover HP panel
- 7 Fixing clip
- 8 Substrate + levelling

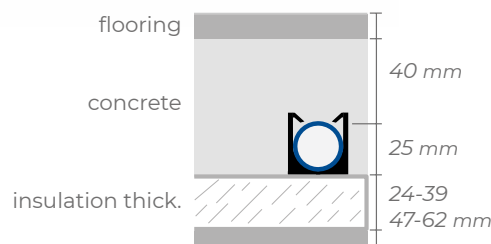

Indicative quotas

Panel thickness	24 mm	39 mm	47 mm	62 mm
Quote with Tiles - Parquet flooring	9.6 - 10.6 cm	11.1 - 12.1 cm	11.9 - 12.9 cm	13.4 - 14.4 cm
Quote with Marble - Blockboard flooring	10.6 - 12.6 cm	12.1 - 14.1 cm	12.9 - 14.9 cm	14.4 - 16.4 cm

Installation notes

- If the floor is in direct contact with the ground (i.e. without a sanitary void or insulating sheathing), provide a polyethylene sheet to act as a moisture barrier.
- Check that the site is clear
- Check the dimensions available, taking into consideration the thickness of the insulation, screed and flooring chosen
- Lay the perimeter belt and the insulation panels
- Lay the pipe fixing clips according to the circuit paths specified in the project
- Lay the pipe
- Usually, it's not necessary to bend the pipe with a bending radius of less than 12.5 cm, i.e. with a laying pitch of less than 25 cm
- Test the system and leave it under pressure until all subsequent works are completed

Note: Please refer to the installation manual for more information.

PRODUCTS THAT COMPOSE THE SYSTEM

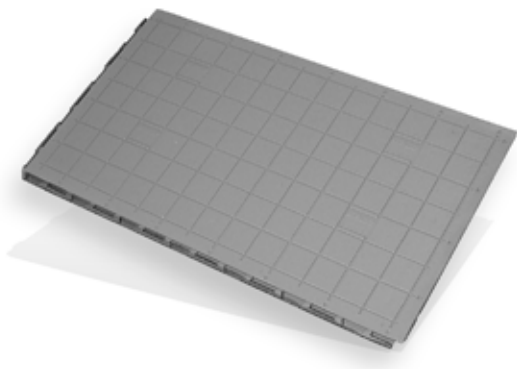

Smooth Cover HP Panel

Smooth Cover HP panel is made of waterproof expanded polystyrene with graphite, produced in conformity with UNI EN 13163, with closed-cell structure, which has high compression strength. It is combined with a special plastic film in order to protect it from humidity in compliance with EN 1264. These panels have a tongue along the perimeter to connect them for proper combination. Spacing of 8.3 cm.

SIZE	THICKNESS	CODE
1161x663 mm	24 mm	1056424
1161x663 mm	39 mm	1056439
1161x663 mm	47 mm	1056447
1161x663 mm	62 mm	1056462

Panel features	Symbol	24	39	47	62	Unit	Standard
Necessary length	L1	1161				mm	UNI EN 822
Necessary width	W1	663				mm	UNI EN 822
Total thickness	T4	24	39	47	62	mm	UNI EN 823
Compressive stress at 10% deformation	CS(10)	120				kPa	UNI EN 826
Compressive stress at 5% deformation		85				kPa	
Compressive stress at 2% deformation		52				kPa	
Thermal conductivity at 10 °C	λ_D	0.031				W/(m·K)	UNI EN 13163
Thermal resistance	R_D	0.75	1.25	1.50	2.00	(m ² ·K)/W	UNI EN 13163
Thermal transmittance	U	1.33	0.80	0.67	0.50	W/(m ² ·K)	
Water vapour diffusion resistance factor	μ (MU)	30 ÷ 70					UNI EN 12086
Water vapour permeability	δ	0.010 ÷ 0.024				mg/(Pa·h·m)	UNI EN 12086
Dimension stability 48h / 70°C	DS(70,-)	≤ 1				%	UNI EN 1604
Fire reaction		F				Euroclass	UNI EN 13501-1
Long term water absorption by partial immersion	Wlp	0.5				kg/m ²	UNI EN 12087
Long-term water absorption by total immersion	WL(T)	≤ 3				%	UNI EN 12087
Limit of operating temperature		70				°C	
Weight		485	786	949	1250	g	
Specific heat	C	1210				J/kg·°k	UNI EN 10456
HIPS Foil thickness		150				µm	
Declaration according to UNI EN 13163							
Unique identification code of the product-type: EPS-EN 13163-T2-L3-W3-S2-P5-BS 170-CS(10)120-DS(70,-)1-WL(T)3-MU(30-70)							



RDZ Tech PE-Xa Pipe Ø 17 Interior Layer

RDZ Tech PE-Xa pipe Ø 17-13 made of high-density cross-linked polyethylene with the oxygen barrier between the PE-X layer and an outer layer made of PE, which ensures further protection during installation in the building site. The layers are combined thanks to a special glue.

TYPE	ROLL	CODE
PE-Xa	240 m	1013840
PE-Xa	600 m	1013850

Note: for further technical data see page 176



RDZ Tech PE-Xc Pipe Ø 20 Interior Layer

RDZ Tech pipe Ø 20-16 mm made of high-density electrophysically cross-linked polyethylene with oxygen barrier. This pipe is produced according to DIN EN ISO 15875/2 and DIN 4726.

TYPE	ROLL	CODE
PE-Xc	240 m	1012240
PE-Xc	600 m	1012600



Plus perimeter belt

Plus perimeter belt is the edge insulation, which absorbs floor expansions and acts as thermo-acoustic insulation for the walls.

SIZE	CODE
5x150 mm	1071250



Fixing clips for 24-39 mm panels

These clips shall be used with relevant fixer in systems with 24/39-mm smooth panels and piping Ø 17 or Ø 20 mm.

SIZE	CODE
For pipe Ø 17 or 20 mm	1017520



Fixing clips for 47-62 mm panels

These clips shall be used with relevant fixer in systems with 47/62-mm smooth panels and piping Ø 17 or Ø 20 mm.

SIZE	CODE
For pipe Ø 17 or 20 mm	1017540



Open Elbow

Open elbow made of plastic material. It is used to support the pipes near the manifolds vertically and to protect them from any damage.

SIZE	CODE
Ø 17 mm	1130517
Ø 20 mm	1140020



Thermofluidifying Additive 4S

Superfluxing, multidosage, water reducing admixture for concrete to increase its workability and to improve its mechanical properties and thermal conductivity. It is a product which conforms to EN 934-2; T3.1 - 3.2.

SIZE	CODE
10 liters	1091911
20 liters	1091921

Tips for material calculation

Needed products	Requirements
Smooth Cover HP panel	Area to be covered +3%
RDZ Tech pipe Ø 17 or Ø 20 mm	Depending on the average pitch. Total = area / pitch [m ² /m]
Plus perimeter belt	1 metre per m ²
Open elbow Ø 17 or Ø 20	2 for each circuit
Fixing clips for 24-39 mm panels	3 per metre of pipe
Fixing clips for 47-62 mm panels	3 per metre of pipe
Humidity Barrier Sheet Grid 10	Area to be covered +20%

Optional products	Requirements
Humidity Barrier Sheet	Area to be covered +20%
Thermofluidifying Additive 4S	Approx. 0.2 litres per m ²
Inhibitor XR20	2% of ENTIRE water content
Biocide XR40	1% of ENTIRE water content

Manifolds, heads, accessories and optional products (from page 162).

Note: The requirements in the table are indicative. Please refer to the construction project for confirmation

THERMAL OUTPUT OF THE SYSTEM

Thermal output in heating

Input data			
Screed coverings above the pipe	s_U	0.045	m
Heat conductivity of screed	λ_E	1.2	W(m·k)
Piper external diameter	d_o	0.017	m
Pipe wall thickness	s_R	0.002	m
Pipe heat conductivity	λ_R	0.35	W(m·k)

K_H																
$R_{\lambda,B} [m^2 \cdot k/W]$																
T cm	0.00	0.01	0.02	0.03	0.04	0.05	0.06	0.07	0.08	0.09	0.10	0.11	0.12	0.13	0.14	0.15
8.3	6.811	6.332	5.917	5.554	5.233	4.948	4.693	4.463	4.255	4.066	3.893	3.734	3.587	3.452	3.327	3.211
16.6	5.345	5.009	4.719	4.466	4.243	4.045	3.860	3.694	3.544	3.408	3.284	3.165	3.054	2.953	2.859	2.772
24.9	4.225	3.990	3.787	3.611	3.457	3.321	3.188	3.070	2.963	2.867	2.779	2.689	2.607	2.531	2.461	2.396

$R_{\lambda,B}$: Heat conduction resistance of the floor covering
 T: Pipe spacing

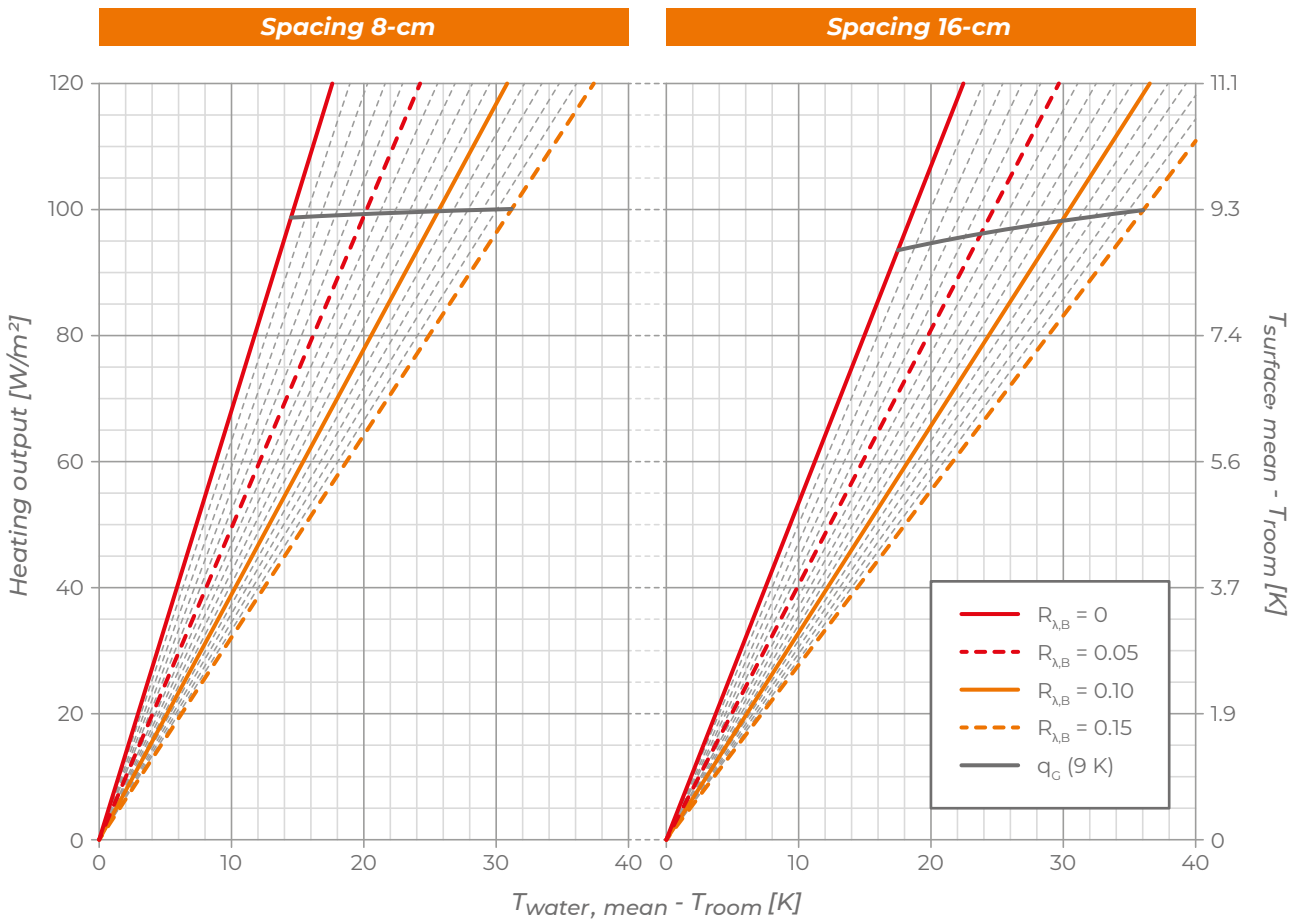

Thermal output in cooling

Input data			
Screed coverings above the pipe	s_U	0.045	m
Heat conductivity of screed	λ_E	1.2	W(m·k)
Piper external diameter	d_o	0.017	m
Pipe wall thickness	s_R	0.002	m
Pipe heat conductivity	λ_R	0.35	W(m·k)

K_H																
$R_{\lambda,B} [m^2 \cdot k / W]$																
T cm	0.00	0.01	0.02	0.03	0.04	0.05	0.06	0.07	0.08	0.09	0.10	0.11	0.12	0.13	0.14	0.15
8.3	4.672	4.444	4.237	4.049	3.877	3.718	3.573	3.438	3.313	3.197	3.088	2.987	2.892	2.803	2.720	2.641
16.6	3.876	3.709	3.557	3.416	3.286	3.165	3.054	2.949	2.852	2.761	2.675	2.595	2.519	2.448	2.380	2.316
24.9	3.221	3.101	2.989	2.885	2.788	2.698	2.613	2.533	2.458	2.387	2.321	2.258	2.198	2.141	2.087	2.036

$R_{\lambda,B}$: Heat conduction resistance of the floor covering
 T: Pipe spacing

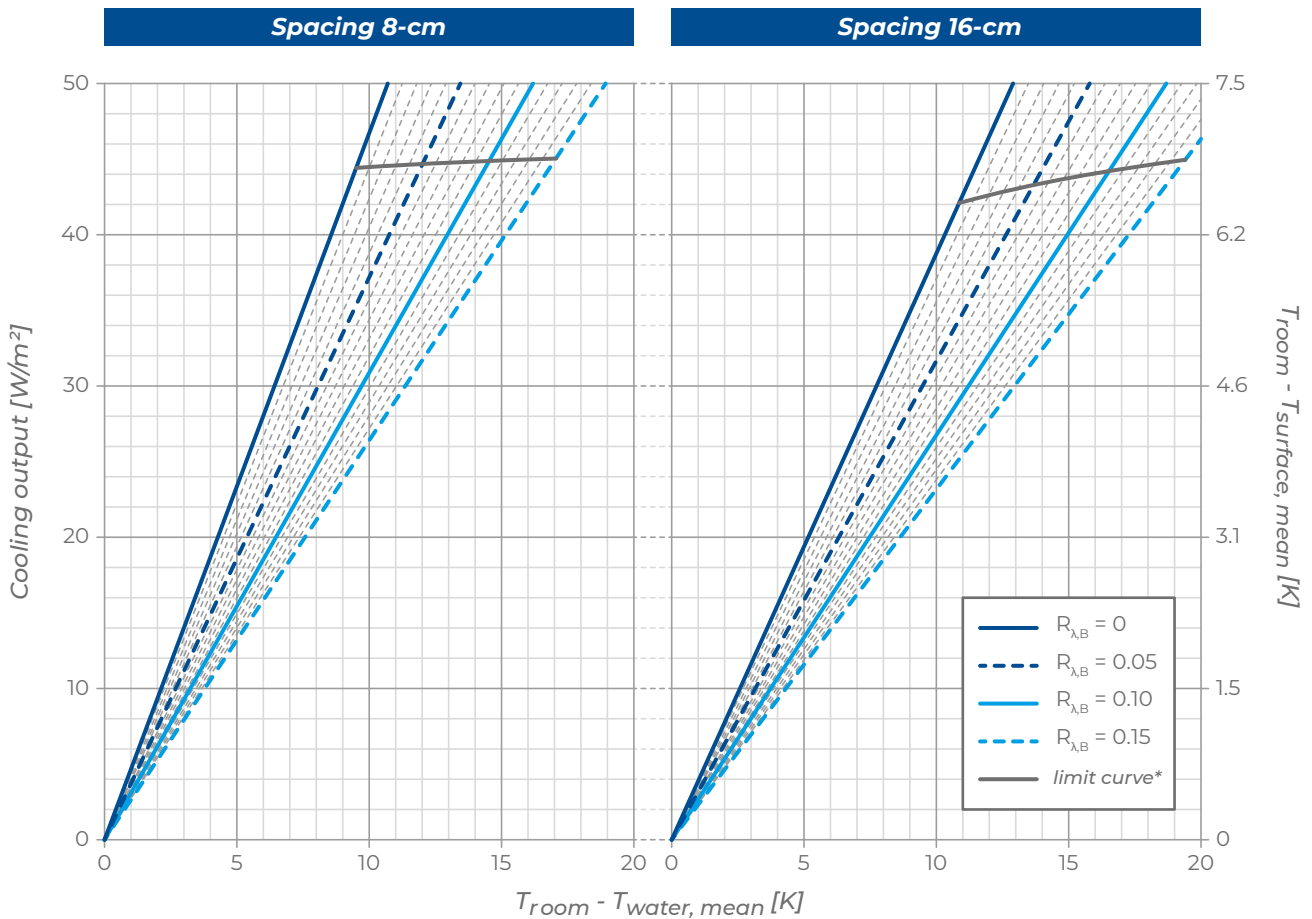

*valid only for room temperature = 26 °C



New Plus is a traditional underfloor radiant heating and cooling system, characterised by pipes anchored to an insulated base and embedded in the screed.

Distinguished by a total footprint of 7.3 cm (including 4 cm of screed, excluding flooring), it is ideal for new constructions, renovations and all applications where it is necessary to reduce the thickness occupied by the radiant system.

The central element of the system is the New Plus waterproof expanded polystyrene studded panel produced in compliance with UNI EN 13163, with closed-cell structure, with dimensions 1000x500x12.5 mm. Thanks to the flooring with plastic film for protection in compliance with EN 1264 and for greater resistance to deformation due to footsteps and thanks to the presence of practical joints on all four sides, it guarantees easy, fast and safe installation.

The system is completed by RDZ Tech PE-X pipe \varnothing 17 mm made of high-density cross-linked polyethylene and equipped with anti-oxygen barrier according to DIN 4726, the hooked clips, the open support elbows, manifold, the Plus perimeter belt and the 4S thermo-fluidifying additive.

FEATURES

- Small footprint
- RDZ Tech \varnothing 17 mm
- High mechanical resistance of the panel
- Suitable for residential and commercial applications
- Quick and easy installation



SECTION AND DIMENSIONS

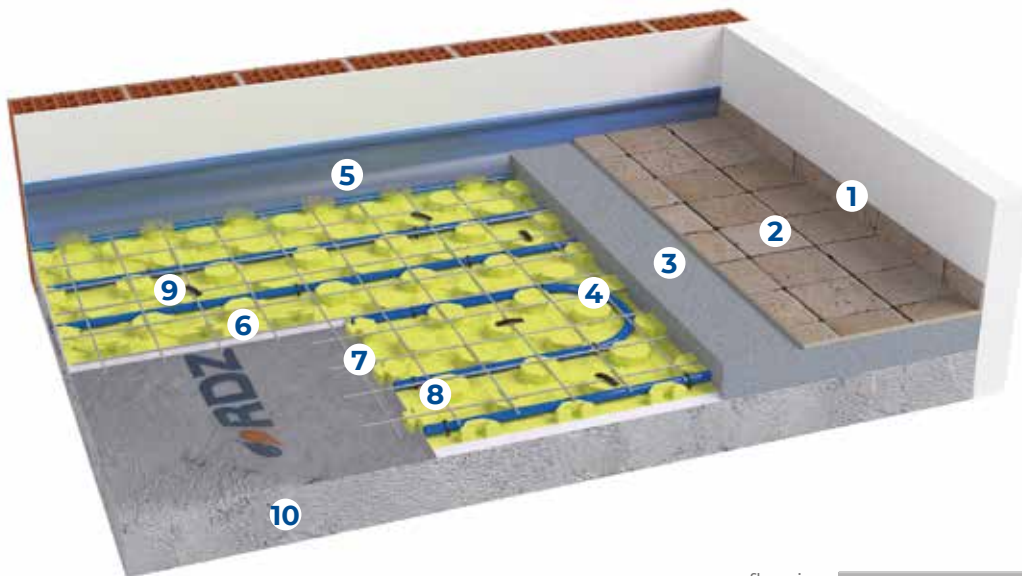

- 1 Skirting board
- 2 Flooring
- 3 Concrete
- 4 RDZ Tech pipe Ø 17-13
- 5 Plus perimeter belt
- 6 New Plus panel
- 7 Anti-shrinkage mesh
- 8 Hooked clip
- 9 Clip 75
- 10 Substrate + levelling

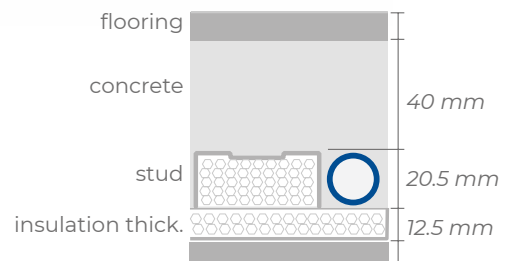

Indicative quotas

Panel thickness	12.5 mm
Quote with Tiles - Parquet flooring	8.3 - 9.3 cm
Quote with Marble - Blockboard flooring	9.3 - 11.3 cm

Installation notes

- If the floor is in direct contact with the ground (i.e. without a sanitary void or insulating sheathing), provide a polyethylene sheet to act as a moisture barrier.
- Check that the site is clear
- Check the dimensions available, taking into consideration the thickness of the insulation, screed and flooring chosen
- Lay the perimeter belt and the insulating panels (where necessary, use the special small blocks to anchor the panel to the substrate)
- Lay the pipe as stated in the project
- Usually, it's not necessary to bend the pipe with a bending radius of less than 12.5 cm, i.e. with a laying pitch of less than 25 cm
- Test the system and leave it under pressure until all subsequent works are completed
- If required, install the anti-shrinkage mesh

Note: Please refer to the installation manual for more information.

■ PRODUCTS THAT COMPOSE THE SYSTEM

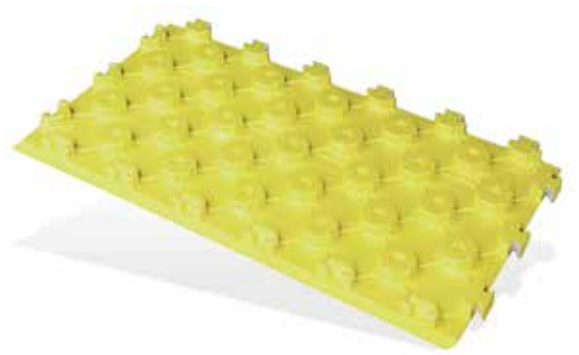

New Plus Panel

New Plus panel with studs made of waterproof moulded expanded polystyrene, produced in conformity with UNI EN 13163, with closed-cell structure, which has high compression strength. It is combined with a plastic film, thickness 0.15 mm, in order to protect it from humidity (in compliance with EN 1264) They have a moulded surface with studs of 20.5 mm so that the pipes can be fitted into the tabs of the panel at spacing of 8.3 cm.

SIZE	THICKNESS	CODE
1000x500 mm	12.5 mm	1043011

Panel features	Value	Unit	Standard
Size	1000x500x12.5	mm	UNI 822
Standard thickness	33	mm	UNI 823
Insulation base thickness	12.5	mm	
Thermal conductivity 10 °C	0.033	W/(m · K)	UNI EN 12667
Resistance to compression with 10 % deformation	250	kPa	UNI 826
Resistance to compression with 5 % deformation	180	kPa	UNI 826
Resistance to compression with 2 % deformation	130	kPa	UNI 826
Thermal resistance calculated on the equivalent thickness	0.50	(m ² · K)/W	EN 1264-3 2009
Thermal resistance base thickness	0,35	(m ² · K)/W	FprEN 1264:2020
Equivalent total thickness	18	mm	UNI EN 1264-3
Water vapour diffusion resistance factor	40 a 100	1	UNI EN 12086
Limit of operating temperature	70	°C	
Thickness of the combined film	150	µm	
Fire reaction	F	Euroclass	EN ISO 11925-2
Declaration according to UNI EN 13163	EPS-EN13163-TI-L1-W1-S2-P4-BS350-CS(10)250-DS(70,-)1-WL(T)3-MU(40-100)		



RDZ Tech PE-Xa Pipe Ø 17 Interior Layer

RDZ Tech PE-Xa pipe Ø 17-13 made of high-density cross-linked polyethylene with the oxygen barrier between the PE-X layer and an outer layer made of PE, which ensures further protection during installation in the building site. The layers are combined thanks to a special glue.

TYPE	ROLL	CODE
PE-Xa	240 m	1013840
PE-Xa	600 m	1013850

Note: for further technical data see page 176



Plus perimeter belt

Plus perimeter belt is the edge insulation, which absorbs floor expansions and acts as thermo-acoustic insulation for the walls.

SIZE	CODE
5x150 mm	1071250



Hooked clip

Hooked clips made of plastic material to ensure secure positioning of the pipe on the insulating panels.

PACKAGE	CODE
100 pieces	1017000



Open Elbow

Open elbow Ø 17 made of plastic material. It is used to support the pipes near the manifolds vertically and to protect them from any damage.

SIZE	CODE
Ø 17 mm	1130517



Thermofluidifying Additive 4S

Superfluxing, multidosage, water reducing admixture for concrete to increase its workability and to improve its mechanical properties and thermal conductivity. It is a product which conforms to EN 934-2; T3.1 - 3.2.

SIZE	CODE
10 liters	1091911
20 liters	1091921



Small Blocks to Fix Panels

Plastic block to prevent panels from moving during pipe installation.

PACKAGE	CODE
100 pieces	1112000

Tips for material calculation

Needed products	Requirements
New Plus Panel	Area to be covered +3%
RDZ Tech pipe Ø17	Depending on the average pitch. Total = area / pitch [m ² /m]
Plus perimeter belt	1 metre per m ²
Open elbow Ø 17	2 for each circuit
Hooked clip	5 for each circuit

Optional products	Requirements
Fibreglass Mesh	Area to be covered +10%
RDZ Fiber (polypropylene fibres)	1 kg per 16 m ²
Clip 75	To be used only if anti-shrinkage mesh is used. 5 clips/m ²
Humidity Barrier Sheet	Surface to be covered +20%
Thermofluidifying Additive 4S	Approx. 0.2 litres per m ²
Inhibitor XR20	2% of ENTIRE water content
Biocide XR40	1% of ENTIRE water content

Manifolds, heads, accessories and optional products (from page 162).

Note: The requirements in the table are indicative. Please refer to the construction project for confirmation

THERMAL OUTPUT OF THE SYSTEM

Thermal output in heating

Input data			
Screed coverings above the pipe	s_U	0.045	m
Heat conductivity of screed	λ_E	1.2	W(m·k)
Piper external diameter	d_o	0.017	m
Pipe wall thickness	s_R	0.002	m
Pipe heat conductivity	λ_R	0.35	W(m·k)

K_H																
$R_{\lambda,B} [m^2 \cdot k/W]$																
T cm	0.00	0.01	0.02	0.03	0.04	0.05	0.06	0.07	0.08	0.09	0.10	0.11	0.12	0.13	0.14	0.15
8.3	6.642	6.185	5.789	5.441	5.133	4.858	4.612	4.390	4.188	4.005	3.837	3.683	3.540	3.408	3.286	3.173
16.6	5.212	4.893	4.617	4.375	4.161	3.971	3.794	3.634	3.489	3.357	3.238	3.121	3.014	2.915	2.824	2.739
24.9	4.120	3.897	3.705	3.537	3.390	3.261	3.134	3.019	2.917	2.824	2.740	2.653	2.572	2.499	2.431	2.368

$R_{\lambda,B}$: Heat conduction resistance of the floor covering
 T: Pipe spacing

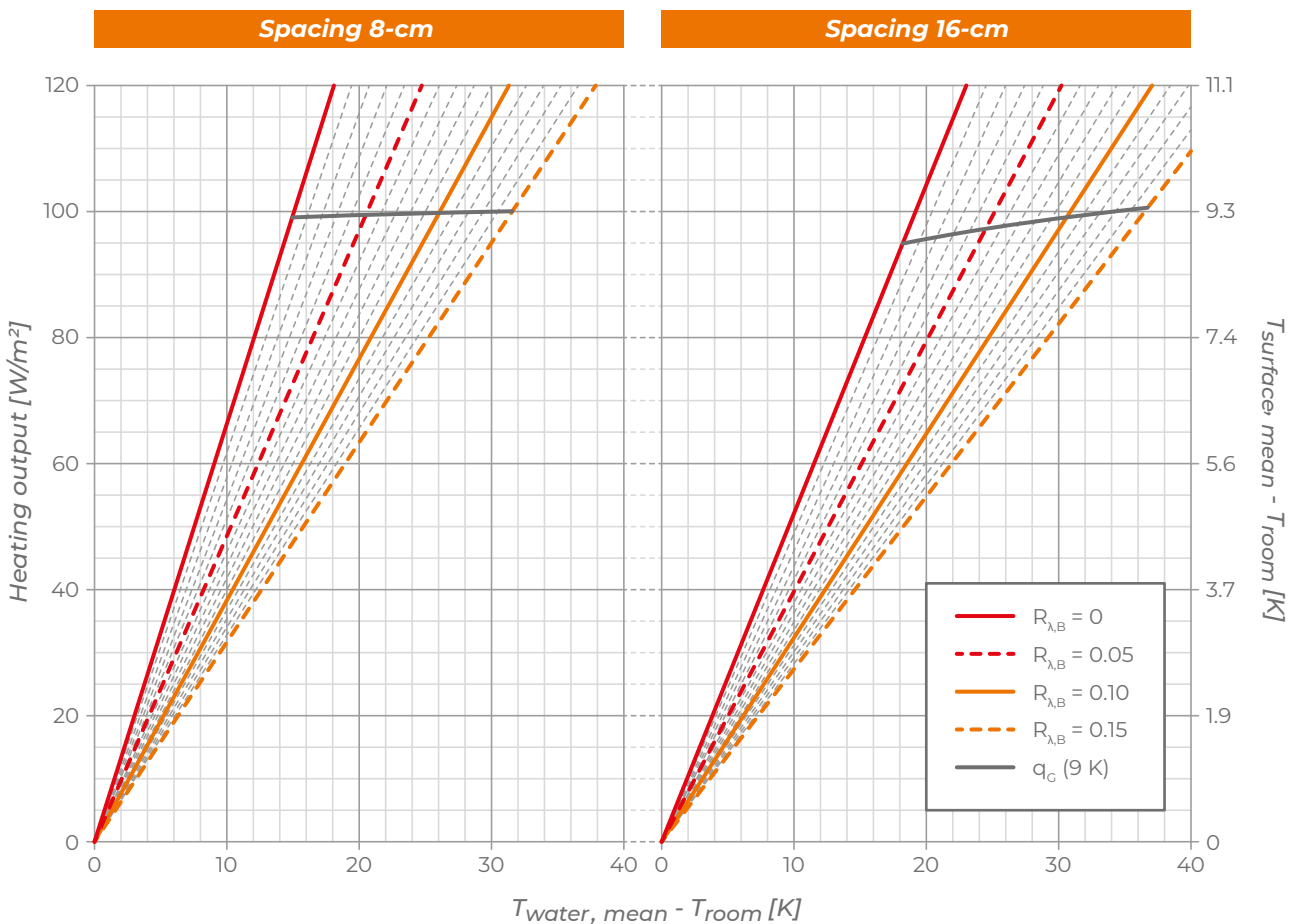

Thermal output in cooling

Input data			
Screed coverings above the pipe	s_U	0.045	m
Heat conductivity of screed	λ_E	1.2	W(m·k)
Piper external diameter	d_o	0.017	m
Pipe wall thickness	s_R	0.002	m
Pipe heat conductivity	λ_R	0.35	W(m·k)

K_H																
$R_{\lambda,B} [m^2 \cdot k/W]$																
T cm	0.00	0.01	0.02	0.03	0.04	0.05	0.06	0.07	0.08	0.09	0.10	0.11	0.12	0.13	0.14	0.15
8.3	4.672	4.444	4.237	4.049	3.877	3.718	3.573	3.438	3.313	3.197	3.088	2.987	2.892	2.803	2.720	2.641
16.6	3.876	3.709	3.557	3.416	3.286	3.165	3.054	2.949	2.852	2.761	2.675	2.595	2.519	2.448	2.380	2.316
24.9	3.221	3.101	2.989	2.885	2.788	2.698	2.613	2.533	2.458	2.387	2.321	2.258	2.198	2.141	2.087	2.036

$R_{\lambda,B}$: Heat conduction resistance of the floor covering
 T: Pipe spacing

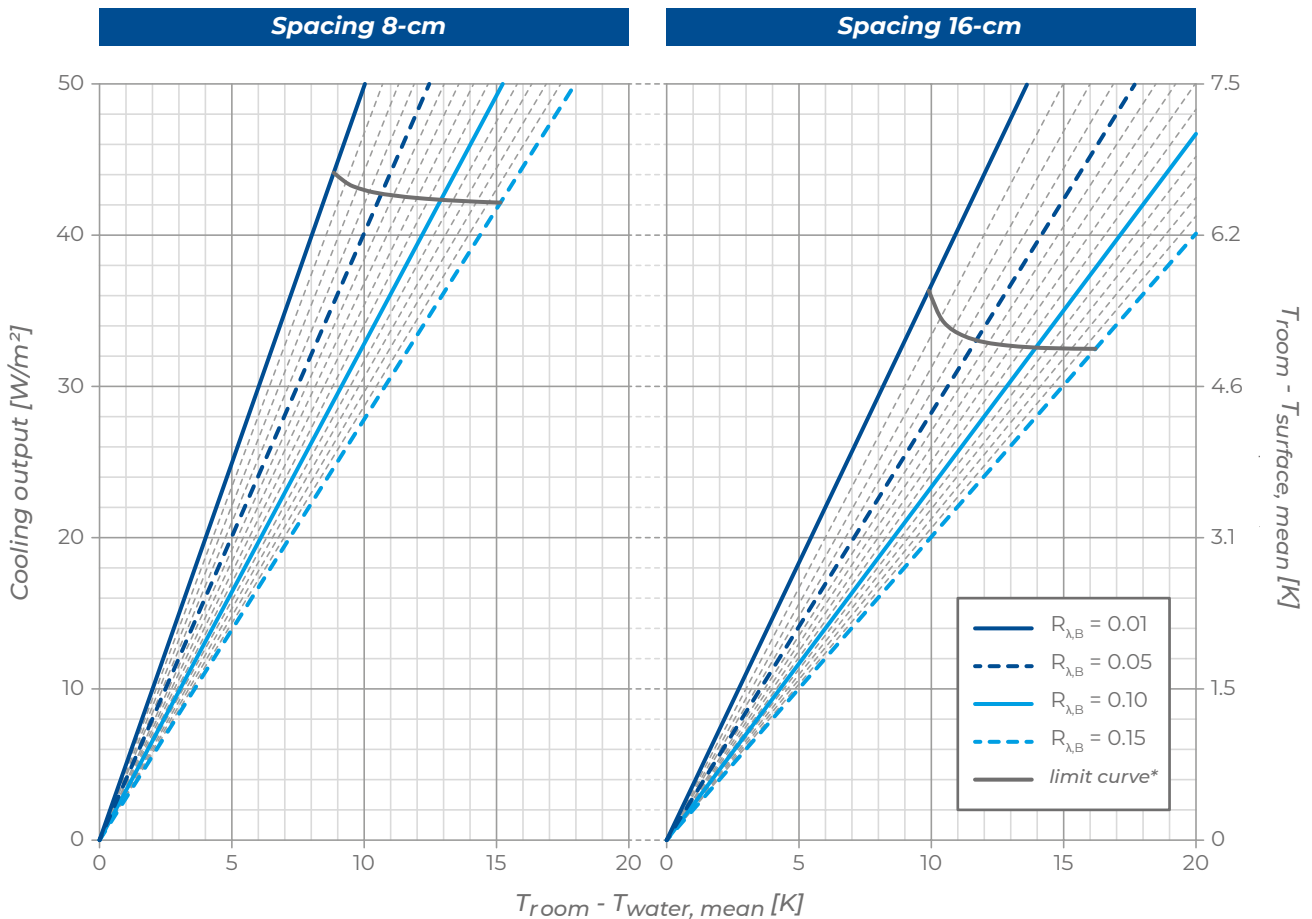

*valid only for room temperature = 26 °C



T50 is a traditional underfloor heating and cooling system, characterised by pipe anchored to the insulated base and embedded in the screed.

The central element of the system is the T50 studded panel made of waterproof moulded expanded polystyrene, produced according to UNI EN 13163, coated superficially with a special plastic film. The presence of tongue on the panel perimeter allows the optimal coupling and guarantee an easy and precise installation.

Thanks to the wide range of available thicknesses (21, 30, 40 and 46 mm), T50 system is able to satisfy several needs in terms of thermal insulation.

The system is completed by RDZ Tech PE-X Ø17 mm and Ø16 mm pipe, made of high-density polyethylene, cross-linked and provided with anti-oxygen barrier according to DIN 4726, the hooked clips, the open support elbows, the manifold, the Easy 15 perimeter belt and the 4S thermo-fluidifying additive.

FEATURES

- Panel in waterproof moulded expanded polystyrene
- RDZ Tech pipe Ø17 mm
- Available in thicknesses 21 - 30 - 40 - 46 mm
- Suitable for residential and commercial applications
- Easy and quick installation



SECTION AND DIMENSIONS

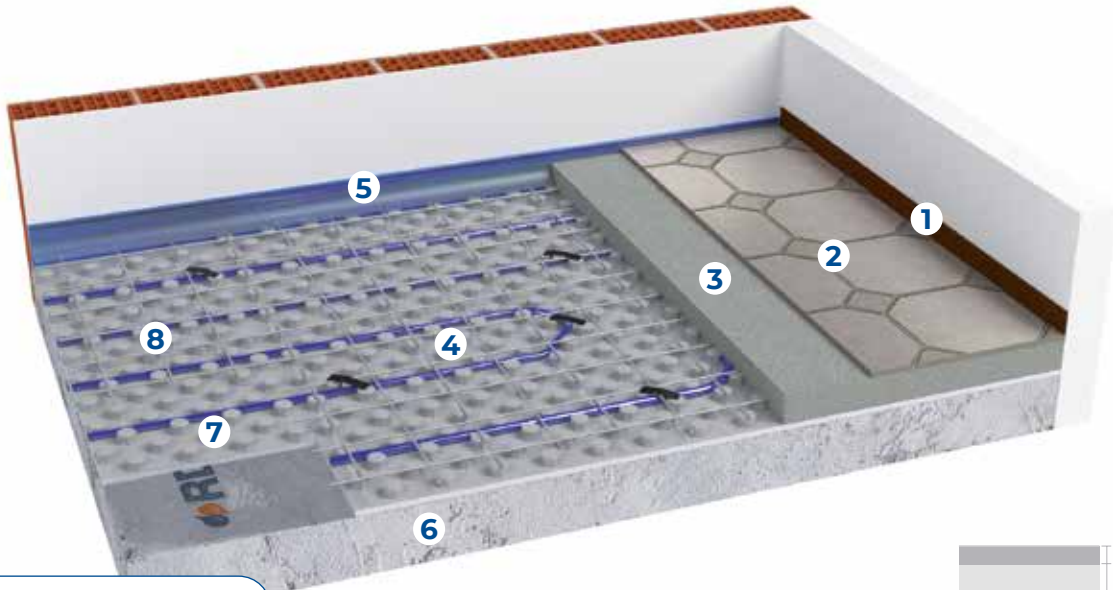

- 1 Skirting board
- 2 Flooring
- 3 Concrete
- 4 RDZ Tech pipe Ø 17-13
- 5 Perimeter belt
- 6 Substrate + levelling
- 7 T50 panel
- 8 Anti-shrinkage mesh

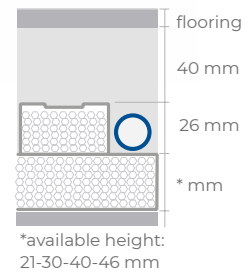

Indicative quotas

Panel thickness	21 mm	30 mm	40 mm	46 mm
Quote with Tiles - Parquet flooring	9.7 - 10.7 cm	10.6 - 11.6 cm	11.6 - 12.6 cm	12.2 - 13.2 cm
Quote with Marble - Blockboard flooring	10.7 - 12.7 cm	11.6 - 13.6 cm	12.6 - 14.6 cm	13.2 - 15.2 cm

Installation notes

- If the floor is in direct contact with the ground (i.e. without a sanitary void or insulating sheathing), provide a polyethylene sheet to act as a moisture barrier.
- Check that the site is clear and clean
- Check the dimensions available, taking into consideration the thickness of the insulation, screed and flooring chosen.
- Lay the perimeter belt and the insulation panels
- Lay the pipes as stated the project
- Usually, it's not necessary to bend the pipe with a bending radius of less than 12.5 cm, i.e. with a laying pitch of less than 25 cm
- Test the system and leave it under pressure until all subsequent works are completed
- If necessary, install the anti-shrinkage mesh

Note: Please refer to the installation manual for more information.

PRODUCTS THAT COMPOSE THE SYSTEM



T50 Panel

Insulating studded panel made of waterproof moulded expanded polystyrene (according to UNI EN 13163), with closed-cell structure, which has high compression strength. This panel is combined with a special plastic film in order to protect it from humidity and to improve its resistance to the deformation of the walking surface. Insulating thickness 21 mm, total thickness 47 mm, equivalent total thickness 27.8 mm. These panels have a tongue along the perimeter to connect them for proper combination. They have a moulded surface with studs of 26 mm, so that the pipes can be fitted into the tabs of the panel at spacing of 5 cm or multiples.

SIZE	THICKNESS	CODE
1200x700 mm	21 mm	1600120
1200x700 mm	30 mm	1600130
1200x700 mm	40 mm	1600140
1200x700 mm	46 mm	1600146

Features	Level - class	21	30	40	46	Unit
Necessary Length	L(3)	1200				mm
Necessary Width	W(3)	700				mm
Total Thickness	T(2)	47	56	66	72	mm
Insulation thickness		21	30	40	46	mm
Equivalent thickness		27.8	36.8	46.8	52.8	mm
Compressive stress at 10% deformation	CS(10)150	≥ 150				kPa
Thermal conductivity	λ_D	0.035				W/(m·K)
Thermal resistance	R_D	0.80	1.05	1.35	1.50	(m ² ·K)/W
Transmittance	U	1.25	0.95	0.70	0.65	W/(m ² ·K)
Water vapour resistance factor	μ (MU)	30 ÷ 70				
Water vapour transmission	δ	0.009 ÷ 0.020				mg/(Pa·h·m)
Long-term water absorption by total immersion	WL(T)5	≤ 5				%
Dimension stability 48 h / 70 °C	DS(70,-)1	1				%
Size stability 23 °C / 50% R.H.	DS(N)2	± 0.2				%
Bending Resistance	BS200	200				kPa
Reaction to fire class		E				Euroclass
Declarations according to UNI EN 13163 : 2013						
Unique identification code of the product-type: T2-L3-W3-S2-P5-BS200-CS(10)150-DS(70,-)1-WL(T)5-MU(30-70)						



RDZ Tech PE-Xa Pipe Ø 17 Interior Layer

RDZ Tech PE-Xa pipe Ø 17-13 made of high-density cross-linked polyethylene with the oxygen barrier between the PE-X layer and an outer layer made of PE, which ensures further protection during installation in the building site. The layers are combined thanks to a special glue.

TYPE	ROLL	CODE
PE-Xa	240 m	1013840
PE-Xa	600 m	1013850

Note: for further technical data see page 176



RDZ Tech PE-Xa Pipe Ø 16

RDZ Tech Pipe PE-Xa Ø 16 is a crosslinked polyethylene pipe manufactured using the Organic Peroxide method, with EVOH oxygen barrier (5 layers) that prevents the permeability of the tube to oxygen diffusion, eliminating the problem of oxygen supply to the water flow and corrosion in the metal elements of the installation extending its lifetime. Diameter 16 mm - Thickness 2 mm.

TYPE	ROLL	CODE
PE-Xa	240 m	1013860
PE-Xa	600 m	1013870



Easy 15 perimeter belt

Is the edge insulation, which absorbs floor expansions and acts as thermo-acoustic insulation for the walls. It is made of expanded polyethylene, and it is provided with an adhesive strip on one side, while on the other side it has a special polyethylene combined sheet in order to avoid infiltrations of mortar between belt and panel. This belt has small cuts on the backside to adjust its height.

SIZE	CODE
5x150 mm	1072150



Hooked clip

Hooked clips made of plastic material to ensure secure positioning of the pipe on the insulating panels.

PACKAGE	CODE
100 pieces	1017000



Open Elbow

Open elbow Ø 17 made of plastic material. It is used to support the pipes near the manifolds vertically and to protect them from any damage.

SIZE	CODE
Ø 17 mm	1130517



Thermofluidifying Additive 4S

Superfluxing, multidosage, water reducing admixture for concrete to increase its workability and to improve its mechanical properties and thermal conductivity. It is a product which conforms to EN 934-2; T3.1 - 3.2.

SIZE	CODE
10 liters	1091911
20 liters	1091921

Tips for material calculation

Needed products	Requirements
T50 Panel	Area to be covered +3%
RDZ Tech pipe Ø 17 mm	Depending on the average pitch. Total = surface area / pitch [m ² /m]
Easy perimeter belt	1 metre per m ²
Open elbow Ø 17	2 for each circuit
Hooked clip	5 for each circuit
Thermofluidifying Additive 4S	Approx. 0.2 litres per m ²

Optional products	Requirements
Fibreglass Mesh	Area to be covered +10%
RDZ Fiber (polypropylene fibres)	1 kg per 16 m ²
Clip 75	To be used only if anti-shrinkage mesh is used. 5 clips/m ²
Humidity Barrier Sheet	Surface to be covered +20%
Inibitor XR20	2% of ENTIRE water content
Biocida XR40	1% of ENTIRE water content

Manifolds, heads, accessories and optional products (from page 162).

Note: The requirements in the table are indicative. Please refer to the construction project for confirmation.

THERMAL OUTPUT OF THE SYSTEM

Thermal output in heating

Input data			
Screed coverings above the pipe	s_U	0.045	m
Heat conductivity of screed	λ_E	1.2	W(m·k)
Piper external diameter	d_o	0.017	m
Pipe wall thickness	s_R	0.002	m
Pipe heat conductivity	λ_R	0.35	W(m·k)

K_H																
$R_{\lambda,B} [m^2 \cdot k/W]$																
T cm	0	0.01	0.02	0.03	0.04	0.05	0.06	0.07	0.08	0.09	0.10	0.11	0.12	0.13	0.14	0.15
10	6,288	5,867	5,502	5,182	4,898	4,645	4,416	4,209	4,021	3,850	3,694	3,549	3,416	3,292	3,178	3,072
15	5,433	5,095	4,801	4,544	4,316	4,114	3,926	3,757	3,603	3,464	3,337	3,214	3,102	2,998	2,902	2,813
20	4,713	4,439	4,203	3,996	3,814	3,652	3,497	3,359	3,233	3,120	3,016	2,913	2,818	2,731	2,650	2,575

$R_{\lambda,B}$: Heat conduction resistance of the floor covering
 T: Pipe spacing

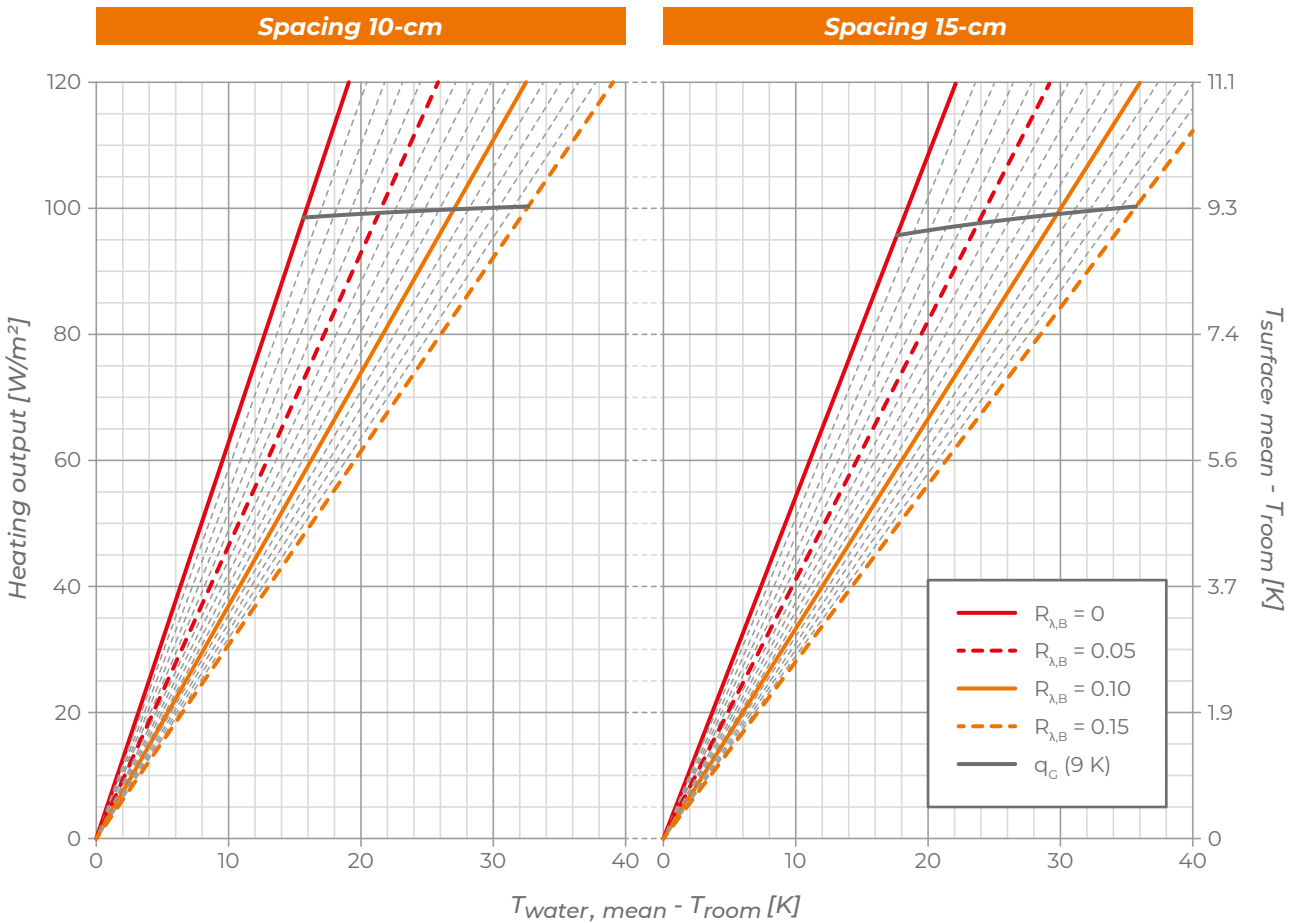

Thermal output in cooling

Input data			
Screed coverings above the pipe	s_U	0.045	m
Heat conductivity of screed	λ_E	1.2	W(m·k)
Piper external diameter	d_o	0.017	m
Pipe wall thickness	s_R	0.002	m
Pipe heat conductivity	λ_R	0.35	W(m·k)

K_H																
$R_{\lambda,B} [m^2 \cdot k/W]$																
T cm	0	0.01	0.02	0.03	0.04	0.05	0.06	0.07	0.08	0.09	0.10	0.11	0.12	0.13	0.14	0.15
10	4,405	4,200	4,013	3,841	3,684	3,540	3,406	3,282	3,166	3,059	2,959	2,864	2,776	2,693	2,615	2,541
15	3,936	3,766	3,611	3,468	3,335	3,213	3,099	2,993	2,894	2,801	2,714	2,633	2,556	2,483	2,415	2,350
20	3,520	3,380	3,251	3,131	3,020	2,917	2,820	2,730	2,645	2,565	2,490	2,420	2,353	2,289	2,230	2,173

$R_{\lambda,B}$: Heat conduction resistance of the floor covering
 T: Pipe spacing

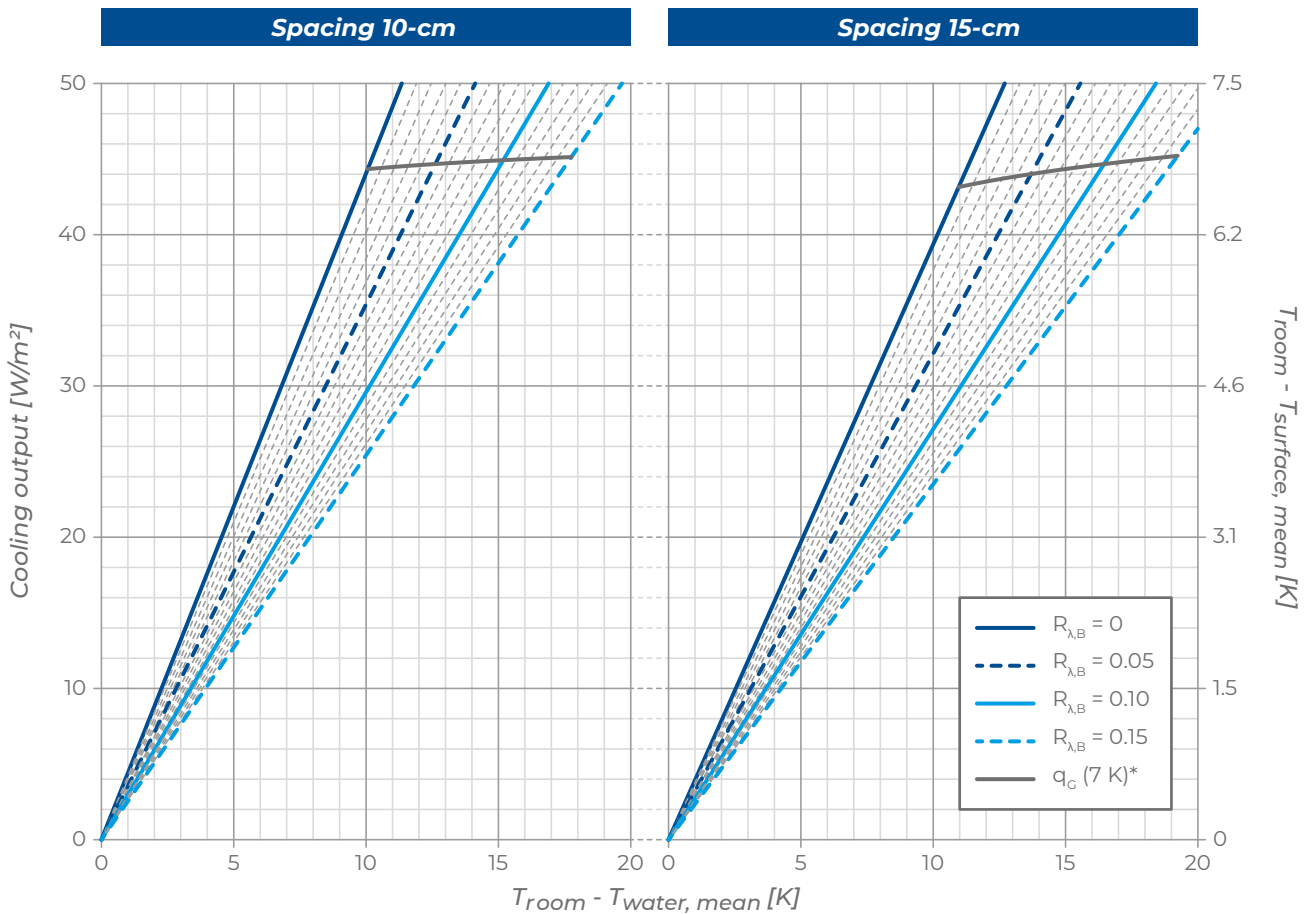

*valid only for room temperature = 26 °C



TF-B HP is a traditional underfloor heating and cooling system, characterised by pipe anchored to the insulated base and embedded in the screed.

The central element of the system is the thermoformed TF-B HP panel, made of sintered expanded polystyrene, produced in conformity to UNI EN 13163. The surface coating is made with a HIPS thermoformed film, that give to the panel a higher resistance to deformation of the walking surface during installation and the presence of tongue along its perimeter allow the optimal coupling between the panels.

Thanks to the wide range of available thicknesses (10, 18, 33 and 40 mm), TF-B HP system is able to satisfy several needs in terms of thermal insulation.

The system is completed by RDZ Tech PE-X Ø17 mm and Ø16 mm pipe, made of high-density polyethylene, cross-linked and provided with anti-oxygen barrier according to DIN 4726, the hooked clips, the open support elbows, the manifold, the Easy 15 perimeter belt and the 4S thermo-fluidifying additive.

FEATURES

- Expanded polystyrene panel with graphite and HIPS thermoformed film
- Thermal insulation with reduced thickness
- Available in thicknesses 10-18-33-40 mm
- Suitable for residential and commercial applications
- Easy and quick installation



SECTION AND DIMENSIONS

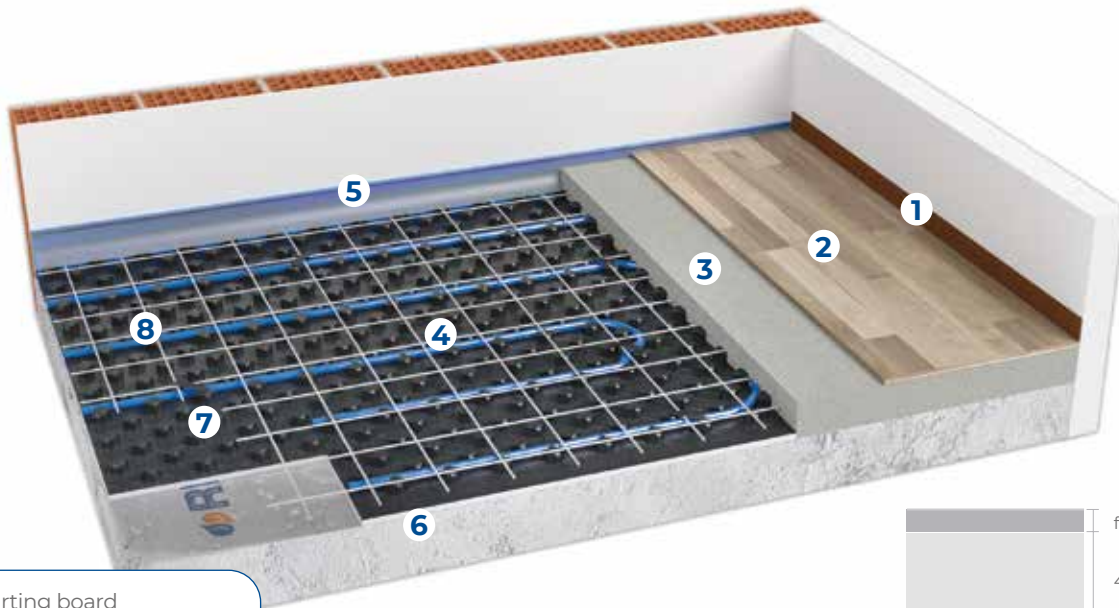

- 1 Skirting board
- 2 Flooring
- 3 Concrete
- 4 RDZ Tech pipe Ø 17-13
- 5 Perimeter belt
- 6 Substrate + levelling
- 7 TF-B HP panel
- 8 Anti-shrinkage mesh

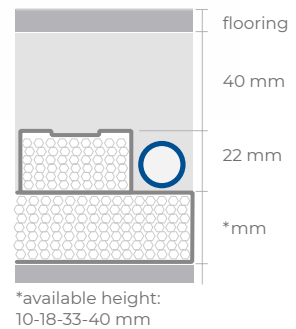

Indicative quotas

Panel thickness	10 mm	18 mm	33 mm	40 mm
Quote with Tiles - Parquet flooring	8.2 - 9.2 cm	9.0 - 10.0 cm	10.5 - 11.5 cm	11.2 - 12.2 cm
Quote with Marble - Blockboard flooring	9.2 - 11.2 cm	10.0 - 11.0 cm	11.5 - 13.5 cm	12.2 - 14.2 cm

Installation notes

- If the floor is in direct contact with the ground (i.e. without a sanitary void or insulating sheathing), provide a polyethylene sheet to act as a moisture barrier.
- Check that the site is clear and clean
- Check the dimensions available, taking into consideration the thickness of the insulation, screed and flooring chosen.
- Lay the perimeter belt and the insulation panels
- Lay the pipes as stated the project
- Usually, it's not necessary to bend the pipe with a bending radius of less than 12.5 cm, i.e. with a laying pitch of less than 25 cm
- Test the system and leave it under pressure until all subsequent works are completed
- If necessary, install the anti-shrinkage mesh

Note: Please refer to the installation manual for more information.

PRODUCTS THAT COMPOSE THE SYSTEM



TF-B HP Panel

TF-B HP panel made of expanded sintered polystyrene with graphite, produced in conformity to UNI EN 13163, with closed-cell structure. It is combined with thermoformed film in HIPS, thickness 0.6 mm, in order to improve its resistance to the deformation of the walking surface according to EN 1264. Compressive strength according to UNI 826 is 150 kPa. These panels have a tongue along the perimeter to connect them for proper combination. The moulded surface with studs of 22 mm allows the pipe to be fitted into the tabs at spacing of 5 cm or multiples.

SIZE	THICKNESS	CODE
1400x800 mm	10 mm	1045610
1400x800 mm	18 mm	1045618
1400x800 mm	33 mm	1045633
1400x800 mm	40 mm	1045640

Properties	Symbol	Thickness				Unit	Standard
		10	18	33	40		
Necessary Length (±3 mm)	L3	1400				mm	UNI EN 13163:2017
Necessary Width (±3 mm)	W3	800				mm	
Total Thickness (±2 mm)	T2	32	40	55	62	mm	
Insulation thickness (±2 mm)		10	18	33	40	mm	
Equivalent thickness		15	23	38	45	mm	
Weight		390	609	1029	1225	g	
Compressive resistance at 10% deformation	CS(10)150	150				kPa	
Thermal conductivity at 10 °C	λ_D	0,030				W/(m·K)	
Thermal resistance	R_D	0.50	0.75	1.25	1.50	(m ² ·K)/W	
Trasmittance		2.00	1.33	0.80	0.67	W/(m ² ·K)	
Water vapour resistance factor	μ (MU)	50 ÷ 90					
HIPS Water vapour resistance factor		10.000				mg/(Pa·h·m)	
Duration of the fire reaction against aging andor degradation		Fire performance for EPS does not change as time goes by					
Duration of the thermal resistance against aging and-or degradation		EPS thermal conductivity does not change as time goes by					
Dimensional stability 23 °C / 50% U.R.		0.2				%	
Reaction to fire class		E				Euroclass	
Water absorption by total immersion	WL(T) 4	≤ 4				%	
Thickness for the thermoformed film in HIPS		600				µm	
Softening temperature		> 90				°C	
Decomposition temperature		> 300					
Auto-ignition temperature		> 400					
Maximum operating temperature		70					
Declarations according to UNI EN 13163:2017							
CLASS: EPS 150		EPS-UNI EN 13163:2017-L3-W3-T2-CS(10)150-WL(T)4-MU(50-90)					



RDZ Tech PE-Xa Pipe Ø 17 Interior Layer

RDZ Tech PE-Xa pipe Ø 17-13 made of high-density cross-linked polyethylene with the oxygen barrier between the PE-X layer and an outer layer made of PE, which ensures further protection during installation in the building site. The layers are combined thanks to a special glue.

TYPE	ROLL	CODE
PE-Xa	240 m	1013840
PE-Xa	600 m	1013850

Note: for further technical data see page 176



RDZ Tech PE-Xa Pipe Ø 16

RDZ Tech Pipe PE-Xa Ø 16 is a crosslinked polyethylene pipe manufactured using the Organic Peroxide method, with EVOH oxygen barrier (5 layers) that prevents the permeability of the tube to oxygen diffusion, eliminating the problem of oxygen supply to the water flow and corrosion in the metal elements of the installation extending its lifetime. Diameter 16 mm - Thickness 2 mm.

TYPE	ROLL	CODE
PE-Xa	240 m	1013860
PE-Xa	600 m	1013870



Easy 15 perimeter belt

Is the edge insulation, which absorbs floor expansions and acts as thermo-acoustic insulation for the walls. It is made of expanded polyethylene, and it is provided with an adhesive strip on one side, while on the other side it has a special polyethylene combined sheet in order to avoid infiltrations of mortar between belt and panel. This belt has small cuts on the backside to adjust its height.

SIZE	CODE
5x150 mm	1072150



Hooked clip

Hooked clips made of plastic material to ensure secure positioning of the pipe on the insulating panels.

PACKAGE	CODE
100 pieces	1017000



Open Elbow

Open elbow Ø 17 made of plastic material. It is used to support the pipes near the manifolds vertically and to protect them from any damage.

SIZE	CODE
Ø 17 mm	1130517



Thermofluidifying Additive 4S

Superfluxing, multidosage, water reducing admixture for concrete to increase its workability and to improve its mechanical properties and thermal conductivity. It is a product which conforms to EN 934-2; T3.1 - 3.2.

SIZE	CODE
10 liters	1091911
20 liters	1091921

Tips for material calculation

Needed products	Requirements
TF-B HP Panel	Area to be covered +3%.
RDZ Tech pipe Ø 17 mm	Depending on the average pitch. Total = area / pitch [m ² /m].
Easy 15 perimeter belt	1 metre per m ²
Open elbow Ø 17	2 for each circuit
Hooked clip	5 for each circuit

Optional products	Requirements
Fibreglass Mesh	Area to be covered +10%
RDZ Fiber (polypropylene fibres)	1 kg per 16 m ²
Clip 75	To be used only if anti-shrinkage net is used. 5 clips/m ²
Humidity Barrier Sheet	Surface to be covered +20%
Thermofluidifying Additive 4S	Approx. 0.2 litres per m ²
Inibitor XR20	2% of ENTIRE water content
Biocida XR40	1% of ENTIRE water content

Manifolds, heads, accessories and optional products (from page 162).

Note: The requirements in the table are indicative. Please refer to the construction project for confirmation..

THERMAL OUTPUT OF THE SYSTEM

Thermal output in heating

Input data			
Screed coverings above the pipe	s_U	0.045	m
Heat conductivity of screed	λ_E	1.2	W(m·k)
Piper external diameter	d_o	0.017	m
Pipe wall thickness	s_R	0.002	m
Pipe heat conductivity	λ_R	0.35	W(m·k)

K_H																
$R_{\lambda,B} [m^2 \cdot k/W]$																
T cm	0	0.01	0.02	0.03	0.04	0.05	0.06	0.07	0.08	0.09	0.10	0.11	0.12	0.13	0.14	0.15
8.1	6,331	5,905	5,535	5,211	4,924	4,669	4,437	4,228	4,038	3,866	3,708	3,562	3,428	3,304	3,189	3,082
12.2	5,471	5,128	4,830	4,569	4,339	4,135	3,945	3,774	3,619	3,478	3,350	3,226	3,113	3,008	2,912	2,822
16.3	4,745	4,468	4,228	4,018	3,834	3,670	3,514	3,374	3,247	3,132	3,028	2,924	2,828	2,740	2,659	2,583

$R_{\lambda,B}$: Heat conduction resistance of the floor covering
 T: Pipe spacing

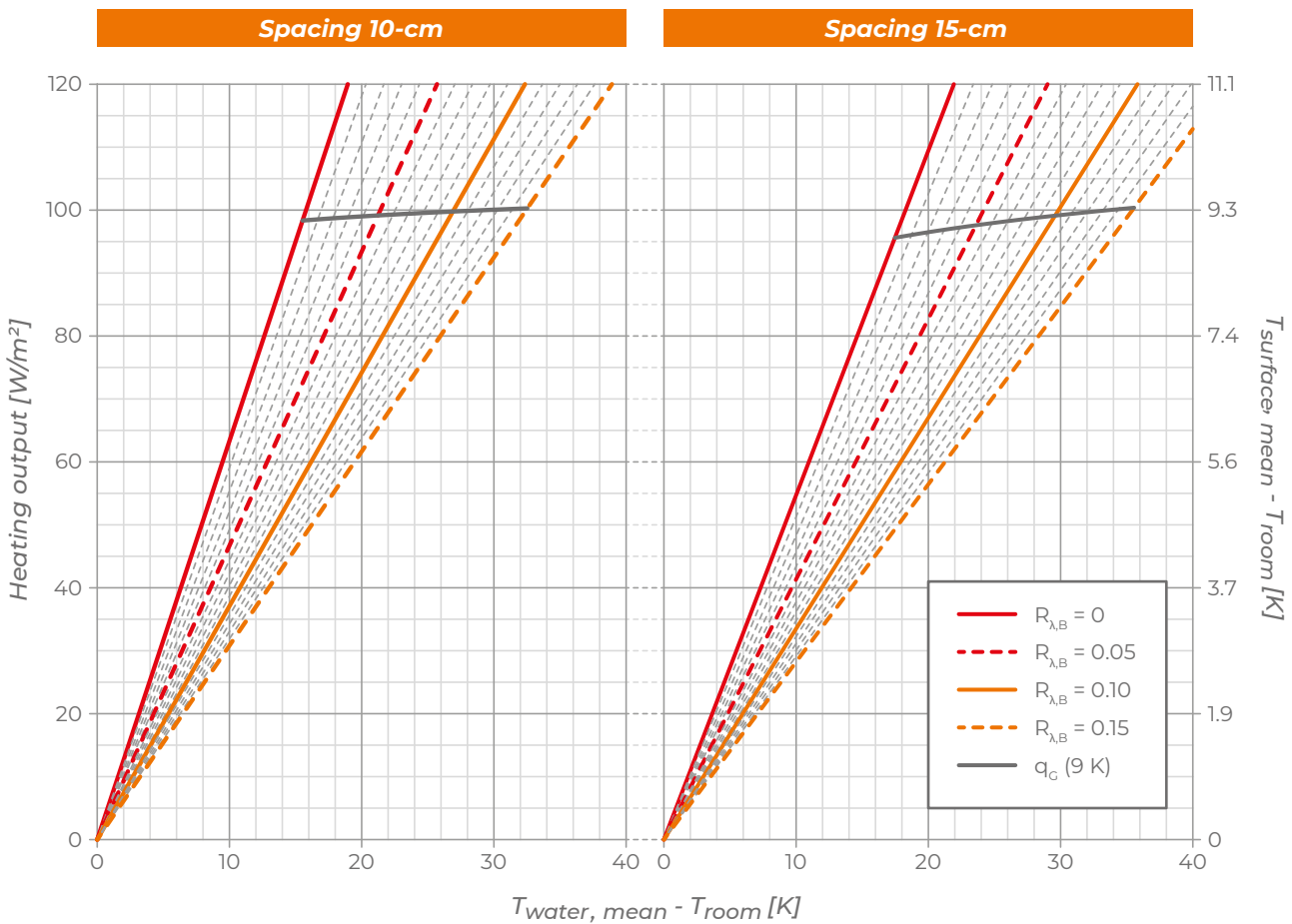

Thermal output in cooling

Input data			
Screed coverings above the pipe	s_U	0.045	m
Heat conductivity of screed	λ_E	1.2	W(m·k)
Piper external diameter	d_o	0.017	m
Pipe wall thickness	s_R	0.002	m
Pipe heat conductivity	λ_R	0.35	W(m·k)

K_H																
$R_{\lambda,B} [m^2 \cdot k/W]$																
T cm	0	0.01	0.02	0.03	0.04	0.05	0.06	0.07	0.08	0.09	0.10	0.11	0.12	0.13	0.14	0.15
8.1	4,426	4,218	4,030	3,857	3,699	3,553	3,418	3,293	3,177	3,069	2,968	2,873	2,784	2,701	2,622	2,548
12.2	3,955	3,783	3,627	3,482	3,349	3,225	3,110	3,003	2,904	2,810	2,723	2,641	2,563	2,490	2,421	2,356
16.3	3,537	3,395	3,265	3,144	3,032	2,928	2,831	2,739	2,654	2,574	2,498	2,427	2,359	2,296	2,235	2,178

$R_{\lambda,B}$: Heat conduction resistance of the floor covering
 T: Pipe spacing

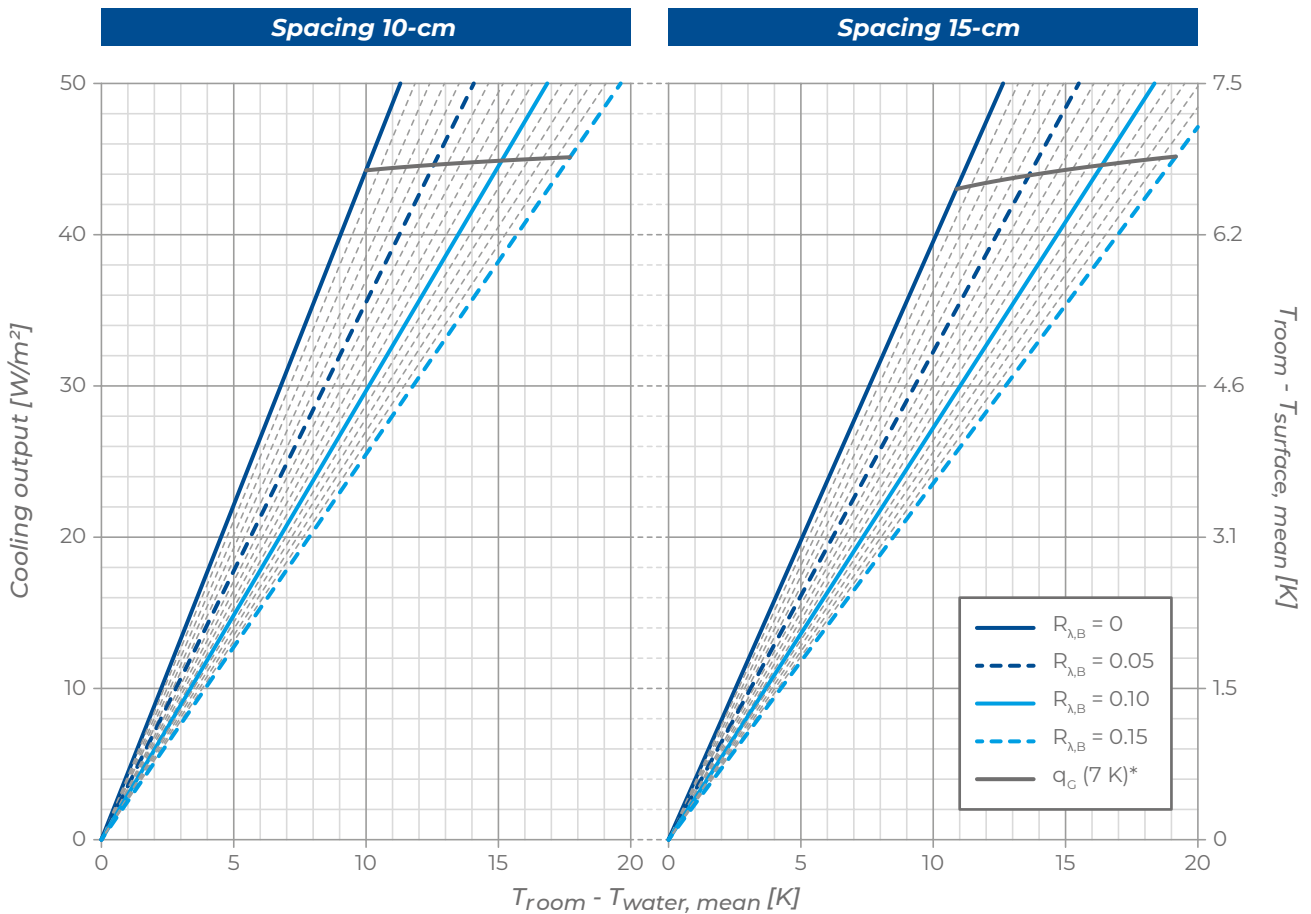

*valid only for room temperature = 26 °C



**Manifolds, pipes
and complements
for underfloor
radiant systems**



Complete, high-performance and efficient systems

Our pipes for underfloor heating and cooling systems are available in a wide range of variants, all characterised by excellent mechanical strength, outstanding corrosion resistance and low oxygen permeability. Flexible and easy to handle, they are also easy and fast to install.

The distribution manifolds allow to keep under control the Δt and the flow rate of either the system and the individual circuit. Available in brass or technopolymer, they can be supplied already assembled in their cabinet. As they are pre-assembled in the factory, they are easy to install and thanks to their reduced depth, they are also suitable for installation in hollow brick walls.

The underfloor systems are completed with a series of accessories designed to offer everything necessary to create high-performance, safe, long-lasting systems that can be customised according to installation and usage requirements.

ADVANTAGES OF MANIFOLDS AND COMPLEMENTS



**WIDE RANGE OF PIPES
SUITABLE FOR EVERY SYSTEM**



**EASY AND QUICK
INSTALLATION**



**WIDE RANGE
OF ACCESSORIES AND COMPLEMENTS**



**VERSATILE PRODUCTS THAT INCREASE
SYSTEMS EFFICIENCY**



Top Composit Pre-assembled Manifold

TOP COMPOSIT manifold Ø 1" is made of thermoplastic, and it is used to distribute the pipes into the rooms. It is provided with flow meters on each circuit, digital flow and return thermometers with a liquid-crystal display, on-off valves (suitable for electrothermal heads), micrometric lockshield valves with data labels to locate rooms, end fittings with ball air vent valves and ball drain valves with hose nozzles and plugs, brackets which can be installed in cabinets or fixed on the wall, and push-fit fittings for polyethylene pipes Ø 12, Ø 17 mm or Ø 16 mm multilayer.

Performance / size	Value	Unit
Liquid	water, glycolic water 30% at most	
Max. Operating Pressure	6	bar
Max. Testing Pressure	6	bar
Operating Temperature	5÷60	°C
Flowmeter Scale	1÷4 (±10%)	l/min
Main outlets of the manifold	1" F Distance between axis 210	Ø mm
Derivations	Push-fit Distance between axis 50	mm

outlets	Ø 12 PB	Ø 16 multilayer	Ø 17 PE-X
3+3	1181203	1181503	1181703
4+4	1181204	1181504	1181704
5+5	1181205	1181505	1181705
6+6	1181206	1181506	1181706
7+7	1181207	1181507	1181707
8+8	1181208	1181508	1181708
9+9	1181209	1181509	1181709
10+10	1181210	1181510	1181710
11+11	1181211	1181511	1181711
12+12	1181212	1181512	1181712
13+13	1181213	1181513	1181713

Dimension of the manifold												
Number of outlet		3+3	4+4	5+5	6+6	7+7	8+8	9+9	10+10	11+11	12+12	13+13
Only Top Composit manifold	cm	25.5	30.5	35.5	40.5	45.5	50.5	55.5	60.5	65.5	70.5	75.5
Top Composit + Ball Valves	cm	35.5	40.5	45.5	50.5	55.5	60.5	65.5	70.5	75.5	80.5	85.5
Top Composit + Zone Valve	cm	39	44	49	54	59	64	69	74	79	84	89
Top Composit + Ball Valves + Zone Valve	cm	43.5	48.5	53.5	58.5	63.5	68.5	73.5	78.5	83.5	88.5	93.5

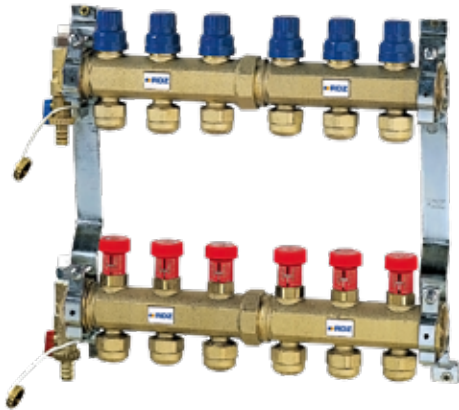

Control Pre-assembled Manifold

CONTROL manifolds Ø 1" 1/4 are made of brass, and they are used to distribute the pipes into the rooms. They are provided with on-off valves (suitable for electrothermic heads), micrometric lockshields with data labels to locate rooms, ball air vent valves and ball drain valves with hose nozzles and plugs, brackets with vibration-damping rubber tops, which can be installed in cabinets or on the wall, and fittings for pipes Ø 17 mm.

Performance / size	Value	Unit
Liquid	water, glycolic water 30% at most	
Max. Operating Pressure	6	bar
Max. Testing Pressure	10	bar
Operating Temperature	5÷100	°C
Main outlets of the manifold	1" 1/4 F distance between axis 210	mm
Derivations	pipe clamp fitting 3/4" 17 - 20 distance between axis 50	Ø mm

outlets	Ø 17 PE-X
3+3	1152803
4+4	1152804
5+5	1152805
6+6	1152806
7+7	1152807
8+8	1152808
9+9	1152809
10+10	1152810
11+11	1152811
12+12	1152812
13+13	1152813

Dimension of the manifold												
Number of outlet		3+3	4+4	5+5	6+6	7+7	8+8	9+9	10+10	11+11	12+12	13+13
Only control manifold	cm	24.5	29.5	35.5	41	46	51	56	61	67.5	72.5	77.5
Control + Initial Fittings	cm	28	33	39	44.5	49.5	54.5	59.5	64.5	71	76	81
Control + Ball Valves	cm	34.5	39.5	45.5	51	56	61	66	71	77.5	82.5	87.5
Control + Zone Valve	cm	38	43	49	54.5	59.5	64.5	69.5	74.5	81	86	91
Control + Initial Fittings + Ball Valves	cm	38	43	49	54.5	59.5	64.5	69.5	74.5	81	86	91
Control + Initial Fittings + Zone Valve	cm	41.5	46.5	52.5	58	63	68	73	78	84.5	89.5	94.5
Control + Ball Valves + Zone Valve	cm	42	47.5	53.5	59	64	69	74	79	85.5	90.5	95.5
Control with all accessories	cm	47	52	58	63.5	68.5	73.5	78.5	83.5	90	95	>100



Easy Steel Pre-assembled Manifold

Pre-assembled manifold Ø 1" made of stainless steel AISI 304, and used to distribute pipe into the rooms. It is equipped with on-off valves (suitable for electrothermic heads) on the return manifold, flow-meters with scale 0 to 5 L/m, digital flow and return thermometers with a liquid-crystal display, air vent valves and drain valves with hose nozzles and plugs, brackets with vibration-damping rubber tops, which can be installed into cabinet or onto the wall.

Available in BASE versions with eurocone outlets suitable for Eurocone 3/4" pipe connectors (to be supplied separately), and in RAPID 17 versions with rapid push fit fitting for pipe Ø 17 mm.

Performance / size	Value	Unit
Liquid	water, glycolic water 50% at most	
Max. Operating Pressure	6	bar
Max. Testing Pressure	6	bar
Operating Temperature	5÷55	°C
Main outlets of the manifold	1" F distance between axis 50	mm
Derivations	Eurocone M 3/4" Push-fit fittings 17	Ø mm

outlets	Easy Steel BASE	Easy Steel RAPID 17
3+3	1426103	1426703
4+4	1426104	1426704
5+5	1426105	1426705
6+6	1426106	1426706
7+7	1426107	1426707
8+8	1426108	1426708
9+9	1426109	1426709
10+10	1426110	1426710
11+11	1426111	1426711
12+12	1426112	1426712
13+13	1426113	1426713

Dimension of the manifold												
Number of outlet		3+3	4+4	5+5	6+6	7+7	8+8	9+9	10+10	11+11	12+12	13+13
Only manifold	cm	23.5	28.5	34.5	40	45	50	55	60	66.5	71.5	76.5
Manifold + Ball Valves	cm	33.5	38.5	44.5	50.5	55	60	65	70	76.5	81.5	86.5
Manifold + Zone Valve	cm	37	42	48	53.5	58.5	63.5	68.5	73.5	80	85	90
Manifold + Ball Valves + Zone Valve	cm	41.5	46.5	52.5	58	63	68	73	78	84.5	89.5	94.5

Cabinet Body Slim



SLIM cabinet made of zinc-plated sheet iron, thickness 0.8 mm, with adjustable feet, height 70÷74, a net on the back, dead holes for side entrances, slide guides for brackets, a protective cover for plaster.

MODEL	CODE
Slim 50	1157650
Slim 75	1157675
Slim 100	1157699

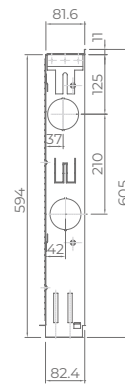
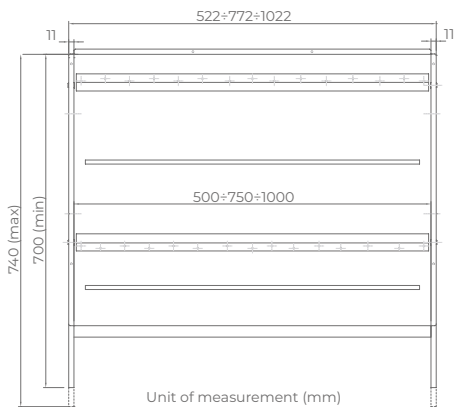

Door and Frame Slim

White metal powder-coated frame and door with lockset for SLIM cabinet. Outward thickness 2 mm. 4 screws are supplied as standard, and they shall be used to fix frame and door to the cabinet body.

MODEL	SIZE FRAME	CODE
Slim 50	560x620x2 mm	1158300
Slim 75	810x620x2 mm	1158375
Slim 100	1060x620x2 mm	1158399

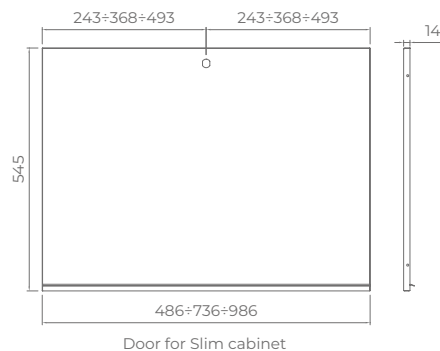
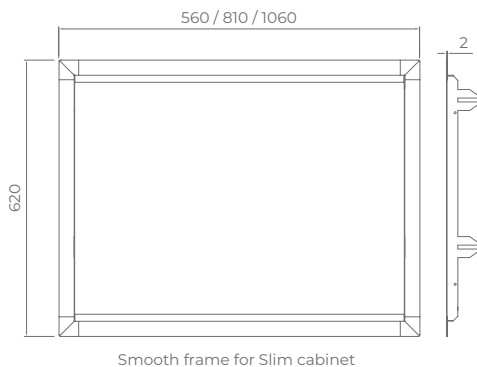



Easy Cabinet

Recessed cabinet made of zinc-plated sheet metal, depth 8 cm, with adjustable feet, a net on the back, dead holes for side entrances, slide guides for a pair of brackets, a protective cover for plaster. It includes flat frame and door made of pre-covered metal sheet and screw-driver lockset.

MODEL	CODE
Easy 50	1600550
Easy 75	1600575
Easy 100	1600599
Easy 120	1600600

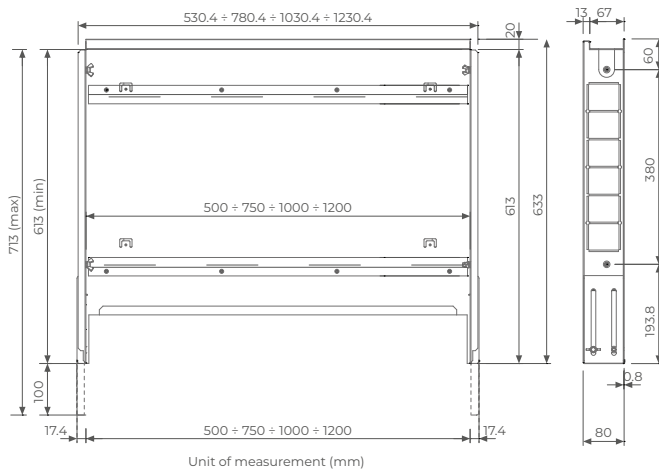

Mixing Group PF

Mixing module suitable for the regulation and control of small underfloor heating systems. It includes a mixing valve with temperature range up to 50 °C (for heating only), electronic circulation pump, one-way valve, balancing bypass, piping for the connection with Easy Steel manifolds, brackets to fix the Mixing Group into the cabinet. High-temperature outlets are NOT available.



PACKAGING	CODE
1 Item	3130066

Overall Dimensions of the Manifold and "MIXING GROUP" Cabinet for "EASY STEEL" Manifolds.

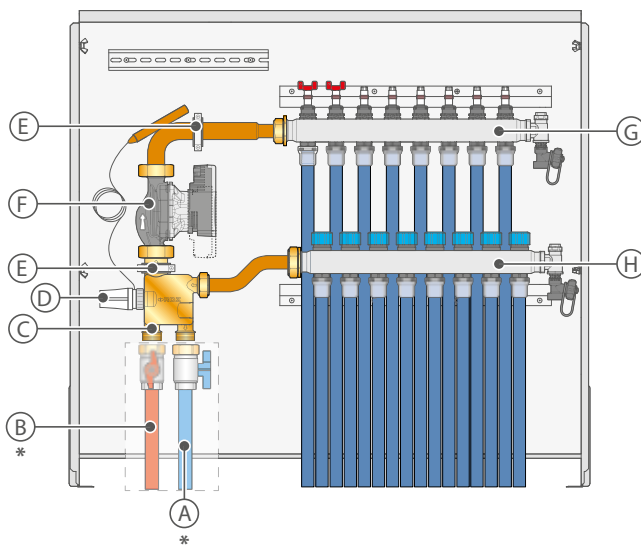

- A F3/4" water production return
- B F3/4" water production supply
- C Mixing unit
- D Thermostatic element
- E Fixing Collars
- F Self-adjusting Electronic Circulator
- G Water supply manifold
- H Water return manifold
- * Provide shut-off valve

Number of outlets	3+3	4+4	5+5	6+6	7+7	8+8	9+9	10+10	11+11	12+12	13+13
Mixing Group + EASY STEEL Manifold	85 cm						120 cm				

Overall Dimensions of the Manifold and “MIXING GROUP” Cabinet for “TOP COMPOSIT” Manifolds

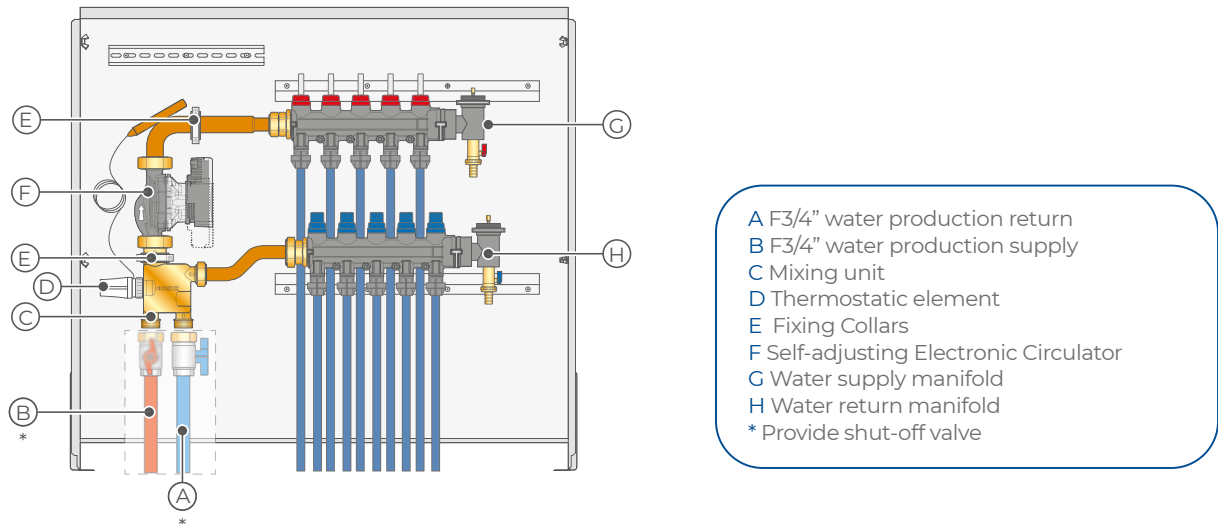

Number of outlets	3+3	4+4	5+5	6+6	7+7	8+8	9+9	10+10	11+11	12+12	13+13
Mixing Group + Top Composit Manifold	85 cm					120 cm					



Cabinet for Mixing Group

Recessed cabinet made of zinc-plated sheet metal, suitable for the installation of the Mixing Group. It is equipped with adjustable feet, metal mesh for plaster, slide guides for brackets, a protective cover for plaster and DIN rail for any accessories such as control bars. It includes flat frame and door made of pre-covered metal sheet and screw-driver lockset.

SIZE LXHXP	CODE
850x750x110 mm	3121085
1200x750x110 mm	3121120



Connection Kit Ø 1"

Double screws Ø 1" for the connection between Mixing Group and Easy Steel or Top Composit manifold.

MODEL	CODE
for Easy Steel manifold	1185016
for Top Composit manifold	1185015

RDZ Electrothermic Head



The thermo-electric actuator performs the shut-off function on each circuit with control by the room thermostat. It can be installed in any position, even upside-down. The function display of the actuator allows identifying the operating condition (open/closed). Easy slot assembly thanks to the adapter (supplied as standard). Voltage: 230V with or without micro-switch or 24V with micro-switch. Protection class: IP54 (all assembly positions). It can be used with b!klimax, TOP COMPOSIT, CONTROL and High-Temperature outlets for KITS.

VOLTAGE	CODE
230 V	1057230
230 V w/micro	1057240
24 V w/micro	1057250

Technical specifications	230 V	24 V
Operating voltage	230 V AC, +10%...-10%, 50/60 Hz	24 V AC/DC, +20%...-10%
Max. inrush current	< 550 mA in 100 ms max.	< 300 mA in max. 2 min
Operating power	1 W *	1 W *
Stroke (actuator travel)	4.0 mm	4.0 mm
Actuating force	100 N ±5%	100 N ±5%
Fluid temperature	0 to +100°C **	0 to +100°C **
Storage temperature	-25°C to +60°C	-25°C to +60°C
Ambient temperature	0 to +60°C	0 °C to +60 °C
Type of protection / Class of protection	IP 54 *** / II	IP 54 (EN 60529) / II
CE conformity according to	EN 60730	EN 60730
Casing	Polyamide, colour: light grey (RAL 7035)	Polyamide, colour: light grey (RAL 7035)
Connection line	type: 2 x 0.75 mm ² PVC, colour: light gray (RAL 7035), length: 1 m	type: 4 x 0.75 mm ² PVC, colour: light gray (RAL 7035), length: 1 m
Weight with connecting cable (1 meter)	100 g	150 g
Surge protection according to EN 60730-1	min. 2.5 kV	

* measured with precision reference instrument LMG95 - ** or higher, depending on the adapter length - *** in all installation positions

Electrical connection

24 V Electrothermic head with micro

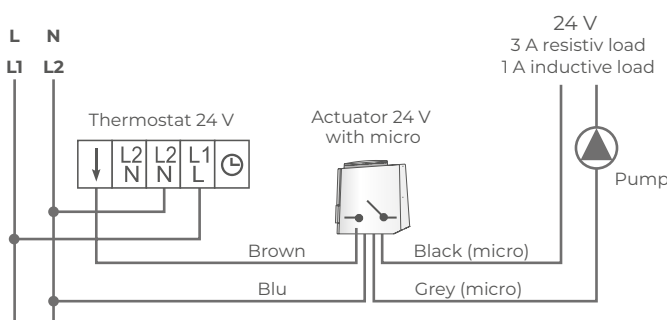

Electrical connection

230 V Electrothermal head

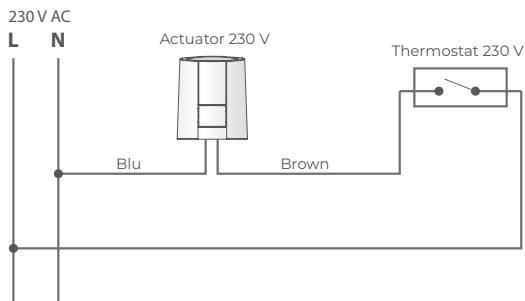

230 V Electrothermic head with micro

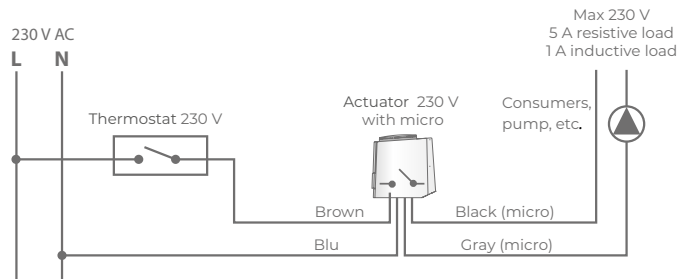

Air Trap

Air traps are used to vent constantly out air from the hydraulic circuits in radiant heating and cooling systems. Venting power of these devices is very high. They make it possible to vent all the air in the circuits, including bubbles, automatically.



With horizontal connections

FLOW RATE	SURFACE	SIZE	CODE
1.9 m ³ /h	up to 60 m ²	Ø 3/4"	6440020
2.6 m ³ /h	up to 85 m ²	Ø 1"	6440025
5.3 m ³ /h	up to 175 m ²	Ø 1 1/4"	6440032
6.3 m ³ /h	up to 210 m ²	Ø 1 1/2"	6440040
9.0 m ³ /h	up to 300 m ²	Ø 2"	6440050

With vertical connections

FLOW RATE	SURFACE	SIZE	CODE
1.9 m ³ /h	up to 60 m ²	Ø 3/4"	6440021
2.6 m ³ /h	up to 85 m ²	Ø 1"	6440026

Operating principle

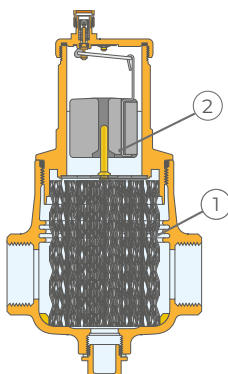

The deaerator uses the combined action of several physical principles. The active part consists of an assembly of concentric metal mesh surfaces (1). These elements create the whirling movement required to facilitate the release of micro-bubbles and their adhesion to these surfaces. The bubbles, fusing with each other, increase in volume until the hydrostatic thrust is such as to overcome the adhesion force to the structure. They rise towards the top of the unit from which they are released through a float-operated automatic air release valve (2). It is designed in such a way that the direction in which the medium is flowing inside it makes no difference.



for Quota Zero AD and Super D system

RDZ Clima PB Pipe Ø 12 mm

RDZ Clima pipe Ø 12 made of polybutylene with anti-oxygen barrier, excellent flexibility for easy installation on low-temperature systems. It is produced in compliance with DIN 16968 and DIN 4726.

DIAMETER	ROLL	CODE
12 mm	300 m	1115120

Application field	CLASS 4	For use with hot and cold water (T_{max} 60 °C)
	CLASS 5	For use with hot and cold water (T_{max} 80 °C)

Outside diam. (mm)	Thickness (mm)	Weight (g/m)	CLASS 4 (bar)	CLASS 5 (bar)	Water content (l/m)
12	1.3	50	10	10	0.069

Pipe Feature	Value	Unit	Standard
Standard			DIN 16968
Oxygen tightness	≤ 0.32	mg O ₂ / (m ² · d)	DIN 4726
Degree of cross-linking	≥ 70	%	
Density	0.920	g/cm ³	ISO 1183
Thermal expansion coefficient at 20 °C	1.3 · 10 ⁻⁴	m/(m·K)	
Thermal conductivity	0.22	W/(m·K)	
Softening temperature	> 130	°C	
Elongation at break a 20 °C	> 300	%	ISO 8986-1
Ultimate Tensile Stress at 20 °C	19	MPa	ISO 8986-2
Max operating temperature	90	°C	
Installation temperature	> -5	°C	
Roughness factor	0.007		

RDZ Tech PE-Xa Pipe Interior Layer Ø 16 mm



for all traditional systems excluding Acurapid

RDZ Tech Pipe PE-Xa Ø 16 is a crosslinked polyethylene pipe manufactured using the Organic Peroxide method, with EVOH oxygen barrier (5 layers) that prevents the permeability of the pipe to oxygen that may cause corrosion of metallic parts in the system. This pipe has a 75% average crosslinking degree that allows major traction and pressure resistance, better stability to temperature variations, installation flexibility and chemical resistance to solvents, air and water. Pipe is certified by the main European Institutes (AENOR, SKZ, CSTB, IIP) complying with the UNE-EN ISO 15875:2004 European regulations and ISO 9001.

Features

DIAMETER	ROLL	CODE
16 mm	240 m	1013860
16 mm	600 m	1013870

Stratigraphy

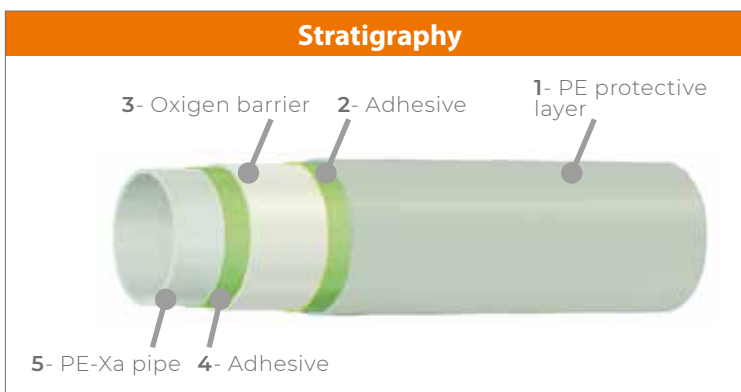

Application field

PE-Xa pipe according to the European regulation UNE-EN ISO 15875:2004 European regulations and ISO 9001	CLASS 4	Heating with radiant panels	T _{max} 70 °C
	CLASS 5	Radiators for high temperature	T _{max} 90 °C

Outside diam. (mm)	Thickness (mm)	Weight (g/m)	Ovality (mm)	CLASS 4 (bar)	CLASS 5 (bar)	Water content (l/m)
16 + 0,3	2 + 0,3	90	0,9	10	8	0,113

	Pipe Feature	Value	Unit
Physical characteristics	Density	951	Kg/m ³
	Degree of crosslinking	> 75	% weight
	Roughness factor	0,007	mm
Thermal characteristics	Maximum service temperature	95	°C
	Maximum high temperature	110	°C
	Heat reversion 120 °C heat; 1 hour	< 2,5	%
	Specific heat at 23 °C	2,3	KJ/(Kg·K)
	Thermal conductivity	0,35 ÷ 0,38	W/(m·K)
	VICAT temperature	130 ÷ 132	°C
	Permeability O ₂	0,08	g/(m ³ ·d)
Mechanical characteristics	Linear extension coefficient	0,026	mm/(m·K)
	Tensile resistance	> 22	N/mm ²
	Elongation at break	> 400	%
	Modulus of elasticity at 20 °C	> 800	N/mm ²
	Internal pressure resistance s=2.5 Mpa, 110 °C	> 1	Year



for e-Dry Tech and e-Dry Evo system

Multilayer PE-RT Pipe Ø 16 mm

PE-RT Type II/Al/PE-RT Type II multilayer pipe Ø 16x2 mm according to UNI EN ISO 21003. SKZ certified. Suitable for use in radiant heating and cooling systems.

Features

THICKNESS	ROLL	CODE
2 mm	300 m	1130016

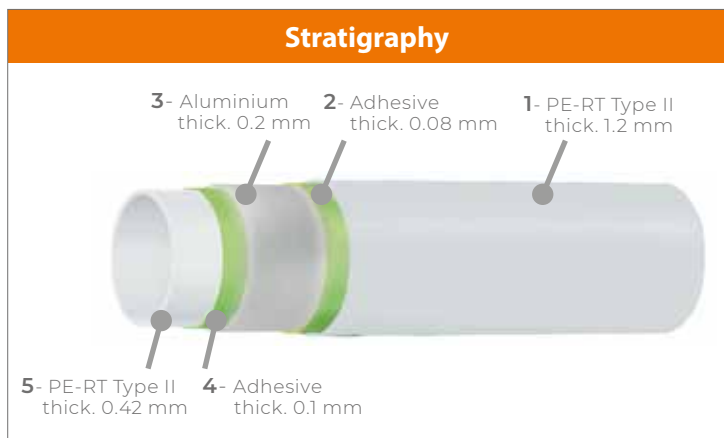

Application field				
Operating conditions according to: UNI EN ISO 21003	Class 2	Domestic hot water (70 °C)	T _{max} 80 °C	Pressure 10 bar
	CLASS 4	Underfloor heating and radiators low temperature	T _{max} 70 °C	Pressure 10 bar

d_n (mm)	e_n (mm)	Water content (l/m)
16	2	0.113

d_n = outer diameter, e_n = wall thickness

Pipe Feature	Value	Unit
Thickness aluminum layer	0.2	mm
Maximum ovalization	0.8	mm
Weight	110	g/m
Roughness factor	0.007	mm
Thermal conductivity	0.45	W / m · K
Thermal expansion coefficient	0.026	mm/m · °C
Permeability to oxygen	0.00	mg/l · h
Radius of curvature	up to 5 times the diameter	



for all traditional systems excluding Acurapid

Easy pipe PE-RT 5L Ø 17 mm

RDZ EASY 5-layer PE-RT (non-crosslinked Polyethylene of Raised Temperature) provided with EVOH anti-oxygen according to DIN 4726, it is suitable for underfloor heating and cooling systems. Diameter 17 mm, Thickness 2 mm, Natural color.

DIAMETER	ROLL	CODE
17 mm	600 m	1014756

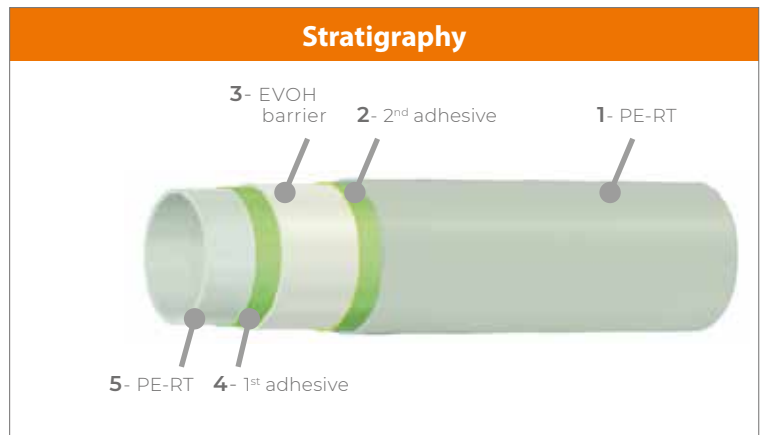

Application field	CLASS 4	For use with hot and cold water (T _{max} 70 °C)	pressure 8 bar
	CLASS 5	For use with hot and cold water (T _{max} 90 °C)	pressure 6 bar

d _n (mm)	e _n (mm)	Water content (l/m)
17	2	0.13

d_n = outer diameter, e_n = wall thickness,

Pipe Feature	Value	Unit
Density	> 941	Kg/m ³
Roughness factor	0,007	mm
Tensile resistance	> 22	N/mm ²
Elongation at break	> 400	%
Thermal expansion coefficient	1,8	10 ⁻⁴ /K
Thermal conductivity at 60°C	0,41	W / m · K
VICAT softening point	124,7	°C
Oxidation induction time (OIT)	> 40	min
Permeability O ₂ at 40 °C	< 0,1	g/ m ³ · d



for all traditional systems excluding Acurapid

RDZ Tech PE-Xa Pipe Ø 17 mm

RDZ Tech Pipe PE-Xa Ø 17 made of high-density electro-physically cross-linked polyethylene with the anti-oxygen barrier between the Pe-Xa layer and an outer layer made of PE, which ensures further protection during installation in the building site. This pipe is produced according to DIN 16892 and DIN 4726, guaranteeing even and stable cross-links and constant characteristics over time.

DIAMETER	ROLL	CODE
17 mm	240 m	1013840
17 mm	600 m	1013850

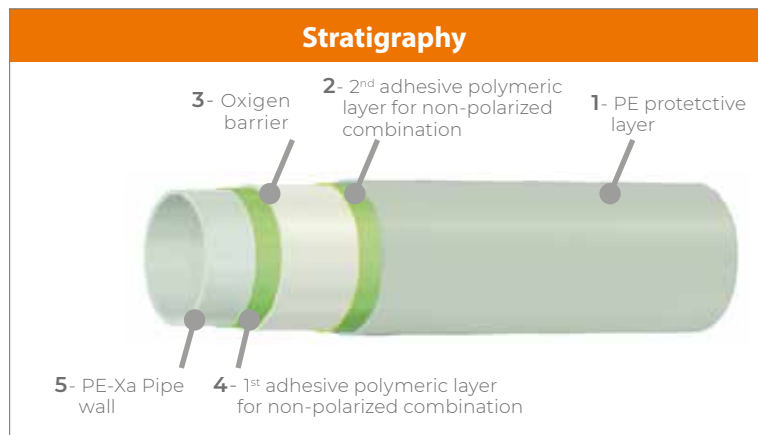

Application field	CLASS 4	For use with hot and cold water (T_{max} 70 °C)
	CLASS 5	For use with hot and cold water (T_{max} 90 °C)

Outside diam. (mm)	Thickness (mm)	Weight (g/m)	CLASS 4 (bar)	CLASS 5 (bar)	Water content (l/m)
17	2	102	8	6	0.131

Pipe Feature	Value	Unit	Standard
Standard			DIN 16892 / DIN 4726
Density	938	Kg/m ³	DIN 53455
Degree of cross-linking	≥ 70	%	ISO 10147
Ultimate Tensile Stress at 20 °C	> 19	N / mm ²	DIN 53455
Elongation at break a 20 °C	> 400	%	ISO 6259
Thermal conductivity	0.40	W / (m · K)	DIN 52612
Oxygen tightness	≤ 0.32	mg O ₂ / (m ² · d)	DIN 4726
Thermal expansion coefficient at 70 °C	1.8 · 10 ⁻⁴	K ⁻¹	DIN 52328
Softening temperature	> 130	°C	DIN 53460
Maximum ovalization	1	mm	
Roughness factor	0.0005		



for Acurapid system

Rapid PE-RT pipe Ø 17 mm

RDZ 17-13 polyethylene pipe with EVOH oxygen diffusion barrier which complies with DIN 4726. It consists in 5 layers PE-RT II/EVOH/PE-RT II ensuring outstanding flexibility & easy handling. A micro-interlocking band is helically wound around the pipe. Certifications: SKZ A236

DIAMETER	ROLL	CODE
17 mm	600 m	1013890

Application field					
Operating conditions according to: DIN EN ISO 15875-1	CLASS 4	For use with hot and cold water	T _{max} 70 °C	over 50 years	Pressure 6 bar
	CLASS 5	For use with hot and cold water	T _{max} 90 °C	max. 1 year	Pressure 6 bar

d _n (mm)	e _n (mm)	Weight (g/m)	Water content (l/m)
17	2	94	0.133

dn = outer diameter, en = wall thickness,

Pipe Feature	Value	Unit	Standard
Density	0.945	g/cm ³	DIN 16833 DIN 16834
Thermal Resistance	0.0050	(m ² · K) / W	
Thermal conductivity	0.40	W / (m · K)	
Oxygen tightness	< 0.1	mg O ₂ / (m ² · d)	
Coefficient of linear expansion	0.195	mm / (m · K)	
Emergency operating temperature, max. 100 hrs	100	°C	
Smallest bending radius without bending device	85	mm	
Smallest bending radius with bending device	34	mm	
Roughness factor	0.007		
Certifications	SKZ A236		



RDZ Tech pipe PE-Xc Ø 20 mm

High density cross-linked polyethylene pipe with anti-oxygen barrier according to DIN 4726 in accordance with DIN EN ISO 15875/2.

DIAMETER	ROLL	CODE
20 mm	240 m	1012240
20 mm	600 m	1012600

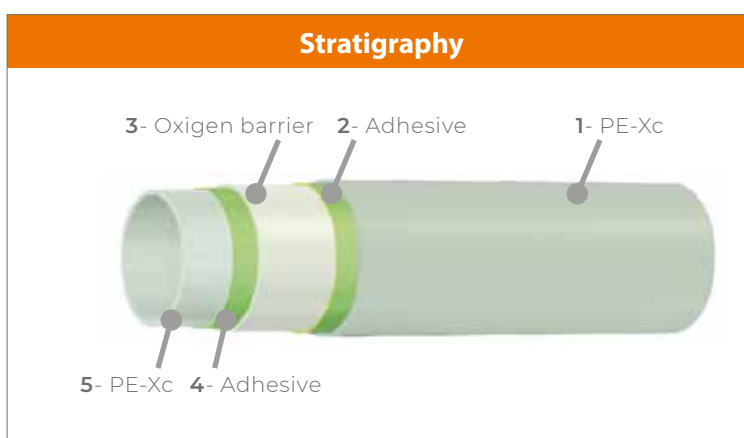

Application field	CLASS 4	For use with hot and cold water (T_{max} 70 °C)
	CLASS 5	For use with hot and cold water (T_{max} 90 °C)

Outside diam. (mm)	Thickness (mm)	Weight (g/m)	CLASS 4 (bar)	CLASS 5 (bar)	Water content (l/m)
20	2	120	8	6	0,20

Pipe Feature	Value	Unit	Standard
Standard			DIN EN ISO 15875 / DIN 4726
Density	0.945	g/cm ³	ISO 1183
Degree of cross-linking	≥ 60	%	
Ultimate Tensile Stress at 20 °C	24-26	N / mm ²	UNI EN ISO 527-2 / EN 60811-1
Elongation at break a 20 °C	400 ÷ 600	%	DIN EN ISO 6259-1 / EN 60811-1
Thermal conductivity	0.41	W / (m · K)	DIN 52612
Oxygen tightness	≤ 0.32	mg O ₂ / (m ² · d)	DIN 4726
Thermal expansion coefficient at 20 °C	1.5 · 10 ⁻⁴	m / (m · K)	
Softening temperature	> 130	°C	
Maximum ovalization	1.2	mm	
Roughness factor	0.0015		

OTHER COMPLEMENTS



Fibreglass Mesh

Alkali-proof fibreglass mesh to reinforce concrete. Pattern: 40x70 mm.

SIZE	CODE
100x200 cm	1092100

Clip 75

The fixing clips are made of plastic material and they are used to secure the reinforcement mesh.

CODE
1111002

Fibreglass mesh characteristics	Value	Unit	Standard
Sheet dimensions	1000x2000	mm	UNI 9311/2
Medium thickness coated fabric	0.95	mm	UNI 9311/3
Mesh size (internal measurements)	40x70	mm	UNI 9311/2
Raw fabric weight	110	g/m ²	UNI 9311/4
Finished fabric weight	130	g/m ²	UNI 9311/4
Construction:			
Warp	2x25	Wires/10 cm	UNI 9311/1
Weft	25	Wires/10 cm	UNI 9311/1
Elongation at break	2.8	%	UNI 9311/5
Tensile breaking load			
Warp	>2.940	N	UNI 9311/5
Weft	>1.330	N	UNI 9311/5



RDZ Fiber

Consists in macro synthetic fibres produced through polypropylene extrusion. It is used to improve the bond within the concrete, thus increasing its workability and strength. Is suitable for concrete on underfloor heating and cooling systems to partially or totally replace the reinforcement mesh.

PACKAGE	CODE
2 bags of 1.5 Kg	1060110

Fiber characteristics	Value	Unit
Diameter	0.75	mm
Fibre length	29	mm
Length/diameter ratio	37.17	
Color	transparent	
Density	~1	g/cm ³
Tensile resistance	400 - 450	N/mm ²
Elastic modulus	4003	MPa
Water absorption	null	
Acids/alkalis resistance	high	
Fiber number per kg	~ 70000	



Humidity Barrier Sheet

The polyethylene sheet should be laid under the insulating panel, thus acting as a humidity barrier.

SIZE	PACKAGE	CODE
Th. 0.18 mm	custom	1901100
Th. 0.18 mm	100 m ²	1901250

Humidity Barrier Sheet Features	Standard	Value		Unit	Tolerance
		1901100	1901250		
Width		4	2	m	± 3 %
Length		-	50	m	± 1.5 %
Thickness	ISO 4593-93	180		μ	± 10 %
Density	ASTM D 1505	0.923		g/cm ³	± 0.005 %
Softening temperature	ASTM D 1525	103		°C	
Water vapour diffusion resistance factor μ	EN 12086	89900		μ	

ACOUSTIC INSULATION FOR SUBSTRATES



Acoustic Mat

Sound-absorbing mat made of elastic expanded dense polyethylene in rolls. It shall be laid under RDZ radiant panels to increase the acoustic performance of the slab. Thickness: 10 mm. Density: 30-33 kg/m³. Thermal conductivity between 0.035 and 0.039 W/m·K. Trample noise reduction as L_w value from lab test: 23 dB.

SIZE HXL	CODE
1300 mm x 50 m	1054230

Mat characteristics		Unit	Value	Standard
Density		Kg/m ³	30 ÷ 33	
Thermal conductivity coefficient		W/m·K	0.035 a 10°C 0.039 a 40 °C	
Maximum working temperatures		°C	-20 ÷ 80	
impact insulation ΔL _w calculated in Institute		dB	23	UNI EN ISO 10140-3:2010 UNI EN ISO 717-2:2007
Impact sound pressure level L' _{n,w} measured on site		dB	58 ÷ 59	
Compressive stress at 10 % deformation		kPa	16.420	UNI EN 826
Dynamic rigidity (MN/m ³)		MN/m ³	43.0	UNI EN 29052-1:1993 EN 29052-1:1992
Toxicity	Conventional toxicity index		10	AFNOR NF F 16-101-1988
	Smoke index		7	
	Smoke class		F1	

Crushing table				
Density of concrete	Screed height	Screed mass per square metre	Pressure exerted by the screed on the slab	Suffered crushing (Thickness 10 mm)
[kg/m ³]	[m]	[kg/m ²]	[Pa]	[mm]
1400	0.10	140	1373.4	0.11
1400	0.15	210	2060.1	0.16
2000	0.10	200	1962.0	0.15
2000	0.15	300	2943.0	0.23



Acoustic Adhesive Tape

Adhesive tape made of expanded polyethylene used to seal the sound absorbing layer (Acoustic mat). It is supplied in rolls of 25 m.

SIZE HXL	CODE
100 mm x 25 m	1054240



Dilation Joint

Dilation joint with adhesive base made of expanded polyethylene. It is ideal to cut the concrete, for example, at the doorway, in order to guarantee the right dilation. Its upper part shall be leveled out once the screed is ready.

SIZE HXL	CODE
100 mm x 2 m	1054220

Joint features	Value	Unit
Length	2000	mm
Height	100	mm
Thickness	7.5 ÷ 9.5	mm
End thickness	30	mm
Dimensional tollerances	± 10	%
Cell structure	Closed cells	
Specific weight	50	kg/m ³
Compressive strength at 10% deformation	9.6	kPa
Standard color	Red	
CFC (freon) free. In compliance with L .549 of 28/12/93		



Acoustic Perimeter Belt

Adhesive edge insulation made of expanded polyethylene with small cuts on the backside to adjust its height. It is equipped with a sheet made of expanded polyethylene, which shall be laid on the soundabsorbing mat. The main function of this edge insulation is to absorb floor expansions and to improve the acoustic insulation of the surface.

SIZE HXL	CODE
160 mm x 50 m	1054200

Belt characteristics	Unit	Value	Note
Density	Kg/m ³	22 ÷ 25	
Thermal conductivity coefficient	W/m-K	0.035 a 10°C 0.039 a 40 °C	
Maximum working temperatures	°C	-20 ÷ 80	
Toxicity standard AFNOR NF F 16-101-1988			CSI Toxicity and Smoke Opacity Test Report No. DC01/494F05 of 07/07/05

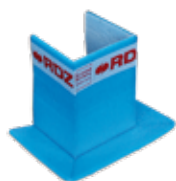

Acoustic Door Edge

Adhesive belt made of expanded polyethylene, which shall be used in corners and wall edges.

SIZE H	CODE
160 mm	1054210

Note: the components for acoustic subfloor insulation can be coupled to traditional RDZ underfloor heating systems



Biocide XR40

This sanitiser provides protection for surface heating and cooling systems against bacterial and fungal contamination. Such contamination can cause blockages in some parts of the installation, for example in the pipes, manifolds, valves or heat exchanger. Non-corrosive substance, easy and quick to dose. Biocide XR40 is compatible with Inibitor XR20, and they shall be both used at first fill of the radiant system in the primary circuit.

SIZE	CODE
3 liters	1091301

Dosage	Application instructions
<p>BIOCIDE XR40 should be dosed at 1% of the water volume, i.e. 1 litre per 100 litres of water content in the system. The 3-litre pack satisfies a typical civil heating system: 80-140 m² house, underfloor heating system and/or radiators.</p>	<p>For an empty system introduce the product at any point in the system before loading water. For a full system, use a dosing device to inject BIOCIDE XR40 at an access point to the system.</p> <p>Permanent treatment: leave in the system.</p>



Inibitor XR20

The inhibiting treatment provides protection for heating systems against corrosion. It can be used in installations with aluminium components, and it is suitable for any kind of installation.

SIZE	CODE
3 liters	1091105
10 liters	1091111

Dosage	Application instructions
<p>INIBITOR XR20 should be dosed at 2% of the water volume, i.e. 2 litres per 100 litres of water content in the system. The 3-litre pack satisfies a typical civil heating system: 15- 25 kW boiler, 80-140 m² house, underfloor heating system and/or radiators. For larger systems, 10 litre packs can be used. An excess of product is not a problem.</p>	<p>For an empty system, introduce the product at any point in the system before filling with water. For a full system, use a dosing device to inject Inibitor XR20 at an access point to the system.</p> <p>Permanent treatment: leave in the system.</p>



Protect-No Freeze

Antifreezing additive with inhibiting treatment to control corrossions, encrustations and the microbiological growth in any kind of heating system, included those systems containing aluminium components.

The dosage of PROTECT - NO FREEZE depends on the level of protection against the cold climate:

- Dosage: 20% suitable up to -6 °C
- Dosage: 30% suitable up to -11 °C
- Dosage: 35% suitable up to -15 °C.

SIZE	CODE
20 liters	1091221

Dosage	Application instructions
<p>The PROTECT - NO FREEZE dosage depends on the desired level of frost protection. A dosage of 20% on the volume of water in the system will protect up to -6 °C, 30% up to -11 °C, 35% up to -15 °C. For best results, it is recommended to rinse the system thoroughly before applying PROTECT - NO FREEZE.</p>	<p>PROTECT - NO FREEZE can be introduced directly at any point in the system, e.g. through a vent valve, or from the expansion tank.</p> <p>Permanent treatment: leave in the system.</p>



Superwash SWR 20

SUPERWASH SWR 20 is the treatment to remove sludge made up of residual corrosion products in heating systems. It can be used in installations with aluminium components too. After using it, empty out the system and rinse it out until the water is clear. Dosage: 1% of the quantity of water in the system.

SIZE	CODE
3 liters	1091404
10 liters	1091411

Dosage	Application instructions
<p>SUPERWASH SWR20 should be dosed at 2% of the water volume, i.e. 2 litres per 100 litres of water content in the system. The 3-litre pack satisfies a typical civil heating system: 15-25 kW boiler, 80-140 m2 house, floor heating system and/or radiators. For larger systems, 10-litre packs can be used. Overdosing does not pose any risk.</p>	<p>Circulate with all radiator valves open and the pump at maximum flow. This can be done either hot or cold and should be continued until satisfactory circulation is re-established. This can take between 2 hours and 2 weeks depending on the severity of the problem. After use, empty the system and rinse until the water is clear. To avoid the formation of sludge, the use of INIBITOR XR20 is recommended.</p> <p>Non-permanent treatment: empty the implant after use.</p>



Thermoregulation devices





Controlled **efficiency**

The correct functioning of a radiant system passes through the choice of the right thermoregulation device which, in addition to guaranteeing the maximum performance of the system, must be able to be easily installed even where space is limited.

For this reason, in order to reduce the overall dimensions and facilitate the preparation of the technical room, we propose a wide range of solutions dedicated to the regulation of the system's parameters, capable of constantly guaranteeing high comfort, maximum efficiency and energy saving.

GM mixing units, compact and easy to install, contain a high-efficiency circulator and a mixing valve for managing the system supply temperature. The GR direct supply unit, on the other hand, can be combined with the GM module to manage heating and cooling in dual temperature systems.

Standard kits are complete and compact substations containing all the necessary components for regulating a radiant underfloor system, they work with wall-mounted boilers equipped with a circulator and allow the connection of high-temperature heating radiators.

ADVANTAGES OF THERMOREGULATION DEVICES



**HIGH COMFORT
IN EVERY BUILDING**



**MAXIMUM EFFICIENCY
OF THE SYSTEM**



**OPTIMISING CONSUMPTION
AND ENERGY SAVING**



**REDUCED
OVERALL DIMENSIONS**



GM PF mixing unit is a central heating device for distributing the thermovector fluid in radiant floor, wall and ceiling systems used only for heating.

The flow temperature is regulated by a fixed-point mixing valve with thermostatic element.

Inside the unit there is a high-efficiency electronic circulator with variable flow rate and head, which ensures low power consumption.

The unit is completed with two shut-off valves with thermometers respectively installed on the supply and return lines of the system, an insulating shell in PPE and a non-return valve to prevent undesired circulations inside the systems with a forced-opening device.

The mixing unit can also be mounted in a multiple version on a wall-mounted manifold.

FEATURES

- Fixed point mixing valve with thermostatic element (range 20 to 55 °C)
- Electronic circulator with variable flow rate and head
- Hydraulic connections Ø 1" M generator side and Ø 1" F system side (DN 25)
- Hydraulic connections Ø 1¼" M generator side and Ø 1¼" F system side (DN 32)
- Hydraulic connection centre distance: 125 mm
- Maximum temperature: 95 °C
- Maximum operating pressure: 8 bar
- Supply voltage: 230V - 50 Hz
- Water flow rate: 1500 l/h with 3 m.w.g. (DN 25)
- Water flow rate: 2200 l/h with 3.5 m.w.g. (DN 32)

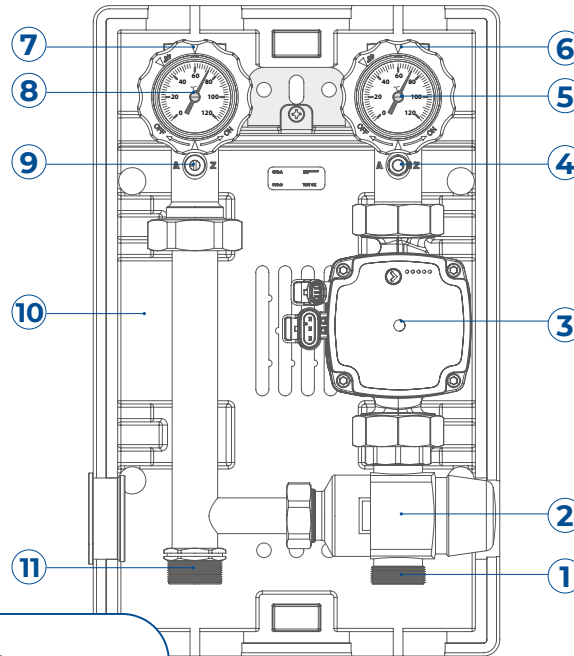

- 1 Water inlet from water heating source
- 2 Fixed point mixing valve
- 3 Circulator
- 4 Probe/safety thermostat holder
- 5 Supply water thermometer with ball valve
- 6 Water supply to the system
- 7 Water return from the system
- 8 Return thermometer with ball valve and non-return valve
- 9 Device for forcing normally open non-return valve
- 10 PPE insulating shell
- 11 Water return to water heating source

DN	CODE
25	3800122
32	3800150

Technical data	Unit	GM PF DN 25	GM PF DN 32
Hydraulic circuit	Max Flow Rate	l/h	1500 / 2200
	Mixer Kvs		4,5 / 4,8
	Max Temperature	°C	95
	Max Pressure	Bar	8
	Liquid		Water / Water + glycol max 30%
Electrical characteristic	Power supply voltage		230 V – 50 Hz
	Max electrical absorption	W	63 / 151
Mechanical characteristics	Shut-off valves		DN 25 / DN 32
	Generator side connections		1" / 1" ¼
	System side connections		1" / 1" ¼
	Distance between connections	mm	125
	Dimensions l x h x p	mm	250x400x210
	Weight	kg	5,3 / 5,6

Example of thermoregulation with the use of GM PF unit

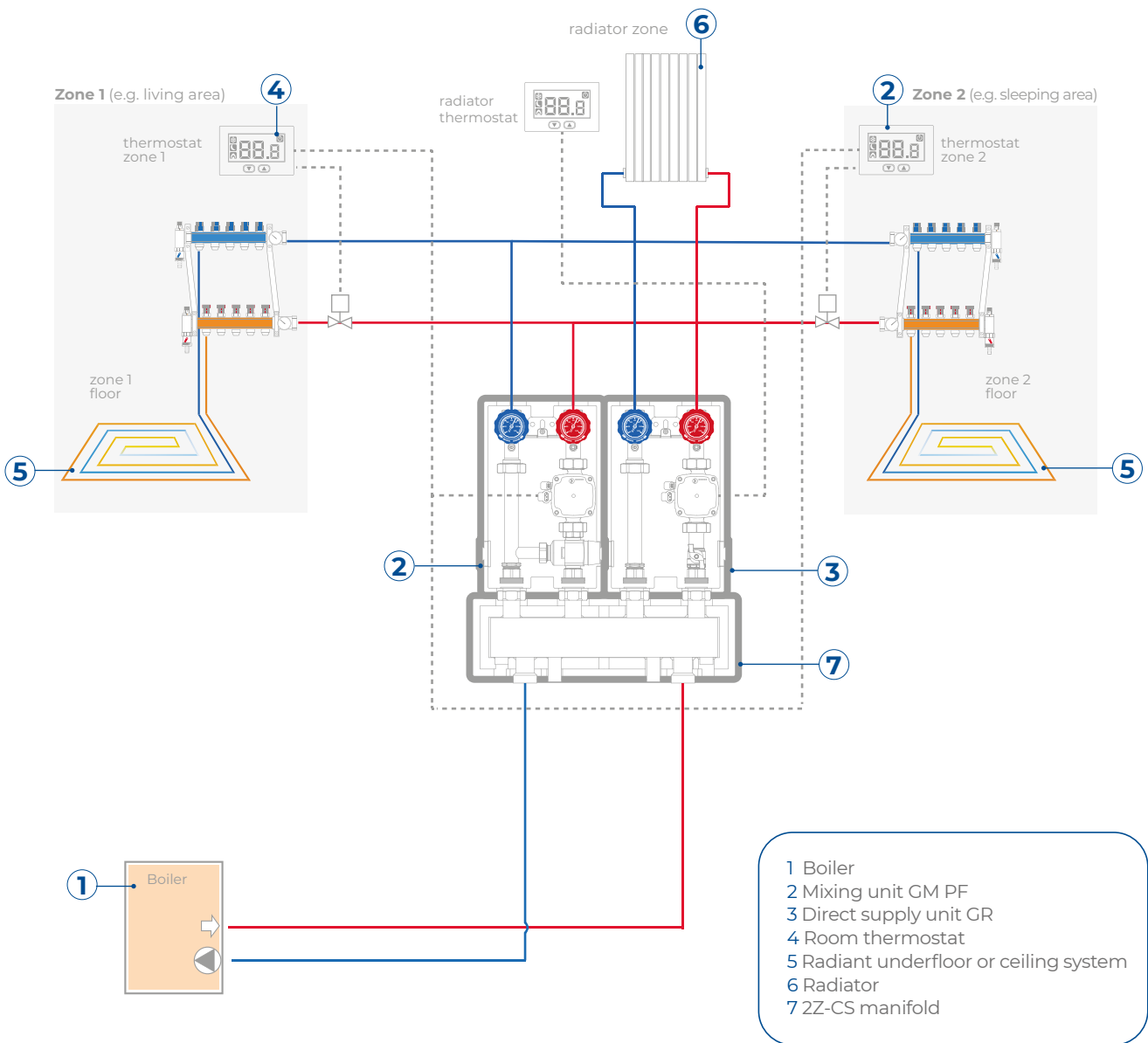

The proposed layout is indicative

■ HYDRAULIC PERFORMANCES

DN 25

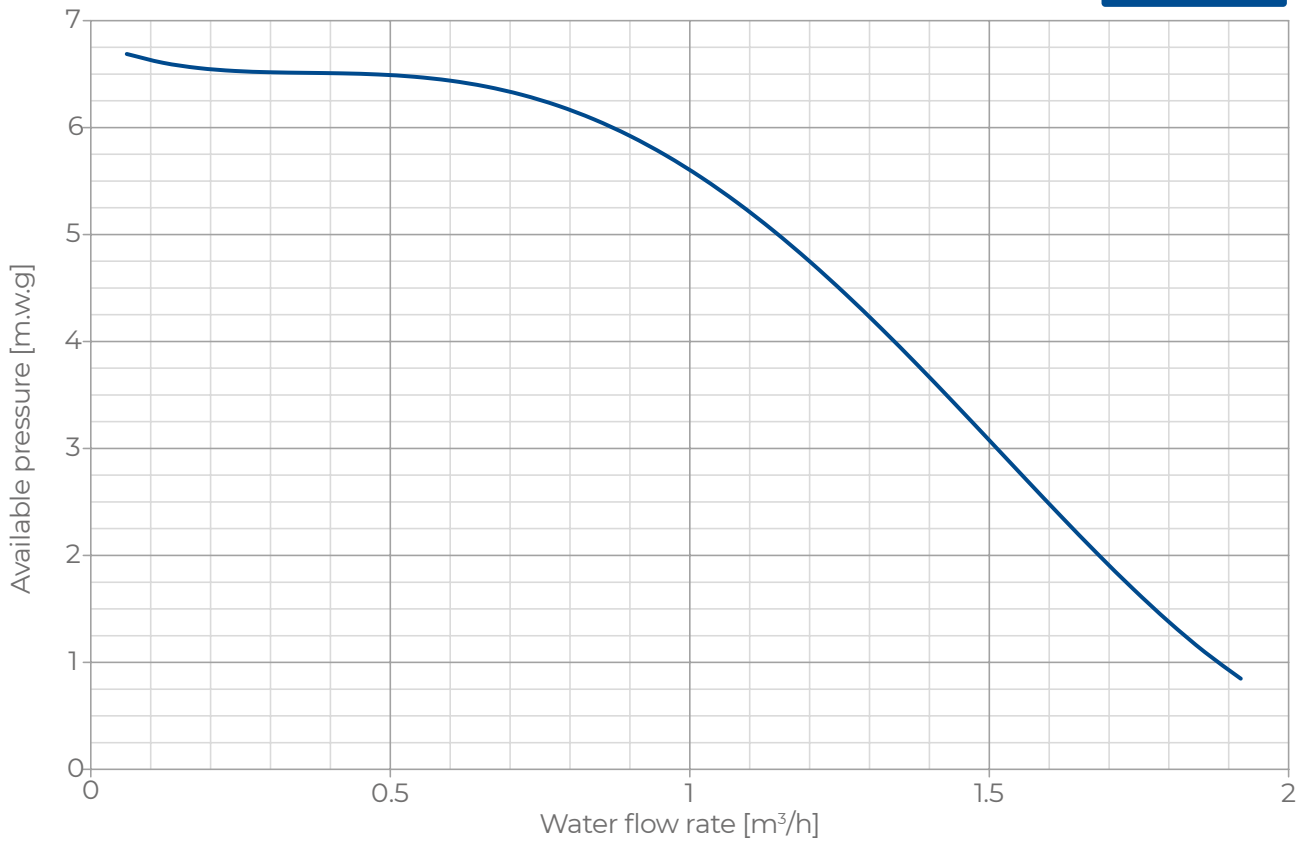

DN 32

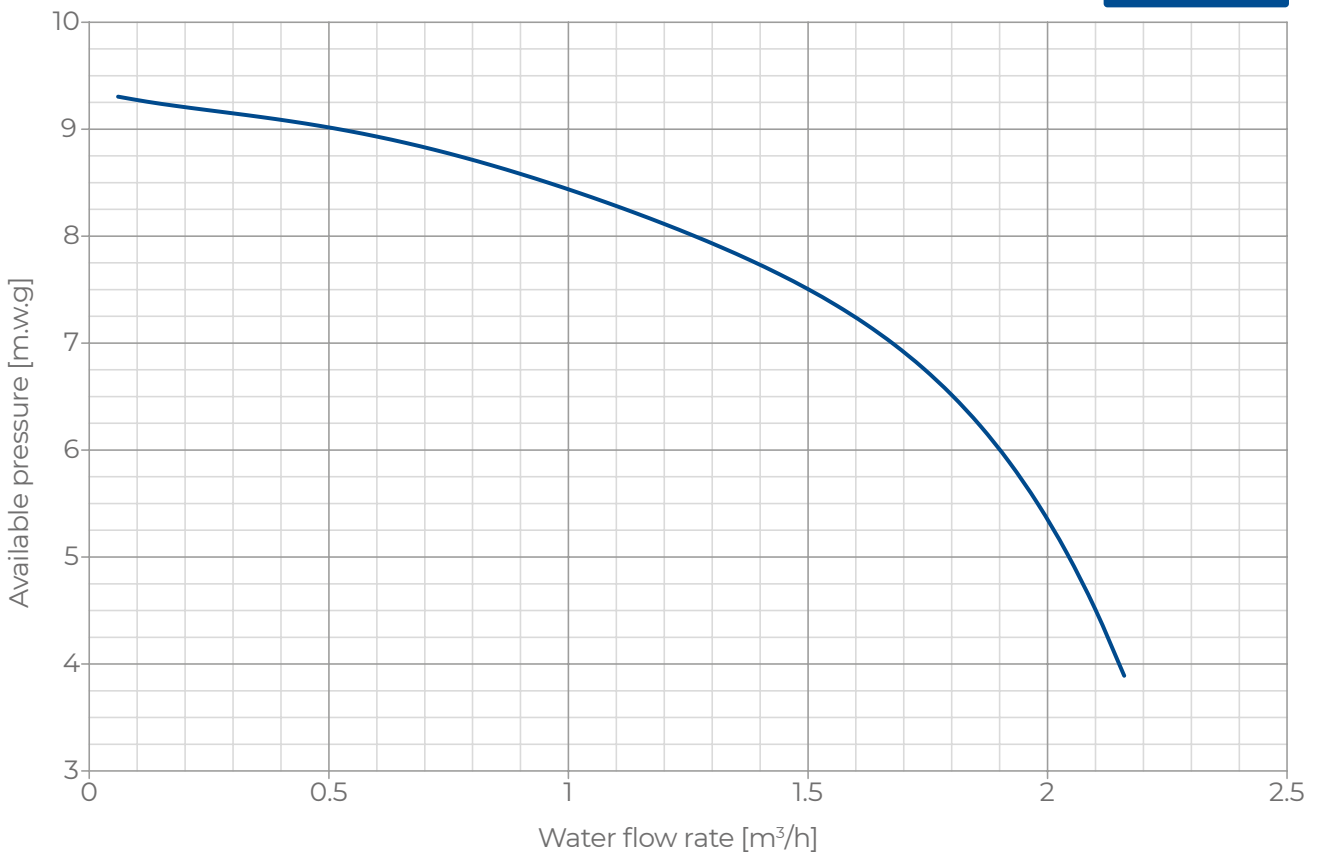



GM PF-CF mixing unit is a technical room device for distributing the thermovector fluid in radiant underfloor, ceiling and wall heating and cooling systems.

The supply water temperature is regulated by an electronic hot/cold fixed point mixing valve. Inside the unit there is a high-efficiency electronic circulator with variable flow rate and head, which ensures low power consumption.

The unit is completed with two shut-off valves with thermometers respectively installed on the supply and return lines of the system, an insulating shell in PPE and a non-return valve to prevent undesired circulations inside the systems with a forced-opening device.

The mixing unit can also be mounted in a multiple version on a wall-mounted manifold.

FEATURES

- Electronic fixed point mixing valve
- Electronic circulator with variable flow rate and head
- Hydraulic connections \varnothing 1" M generator side and \varnothing 1" F system side (DN 25)
- Hydraulic connections \varnothing 1¼" M generator side and \varnothing 1¼" F system side (DN 32)
- Hydraulic connection centre distance: 125 mm
- Maximum temperature: 95 °C
- Maximum operating pressure: 8 bar
- Supply voltage: 230V - 50 Hz
- Water flow rate: 2000 l/h with 3.5 m.w.g. (DN 25)
- Water flow rate: 4000 l/h with 4 m.w.g. (DN 32)

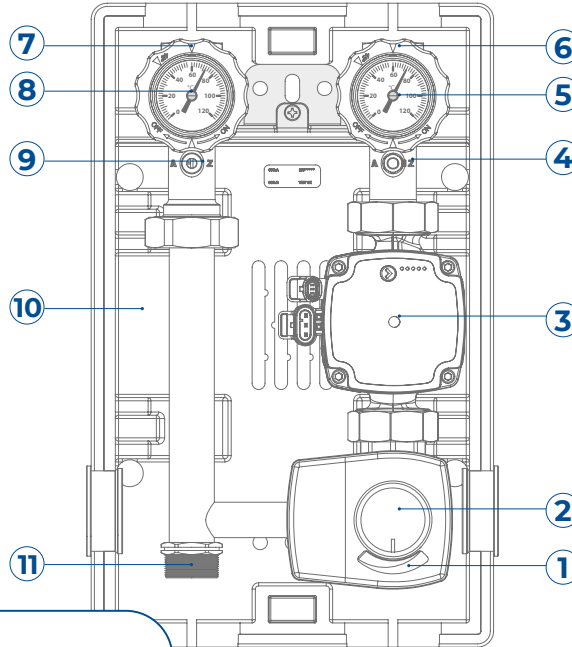

- 1 Water inlet from water production source
- 2 Mixing valve with hot/cold fixed point electronic servomotor
- 3 Circulator
- 4 Probe/safety thermostat holder
- 5 Supply water thermometer with ball valve
- 6 Water supply to the system
- 7 Water return from the system
- 8 Return thermometer with ball valve and non-return valve
- 9 Device for forcing normally open non-return valve
- 10 PPE insulating shell
- 11 Water return to water production source

DN	CODE
25	3800130
32	3800132

Technical data		Unit	GM PF DN 25	GM PF DN 32
Hydraulic circuit	Max Flow Rate	l/h	2000	4000
	Mixer Kvs		13	17
	Max Temperature	°C	95	
	Max Pressure	Bar	8	
	Liquid		Water / Water + glycol max 30%	
Electrical characteristic	Power supply voltage		230 V – 50 Hz	
	Max electrical absorption	W	63	151
Mechanical characteristics	Shut-off valves		DN 25	DN 32
	Generator side connections		1"	1" ¼
	System side connections		1"	1" ¼
	Distance between connections	mm	125	
	Dimensions l x h x p	mm	250x400x210	
	Weight	kg	5.4	5.7

Example of thermoregulation with the use of GM PF-CF unit

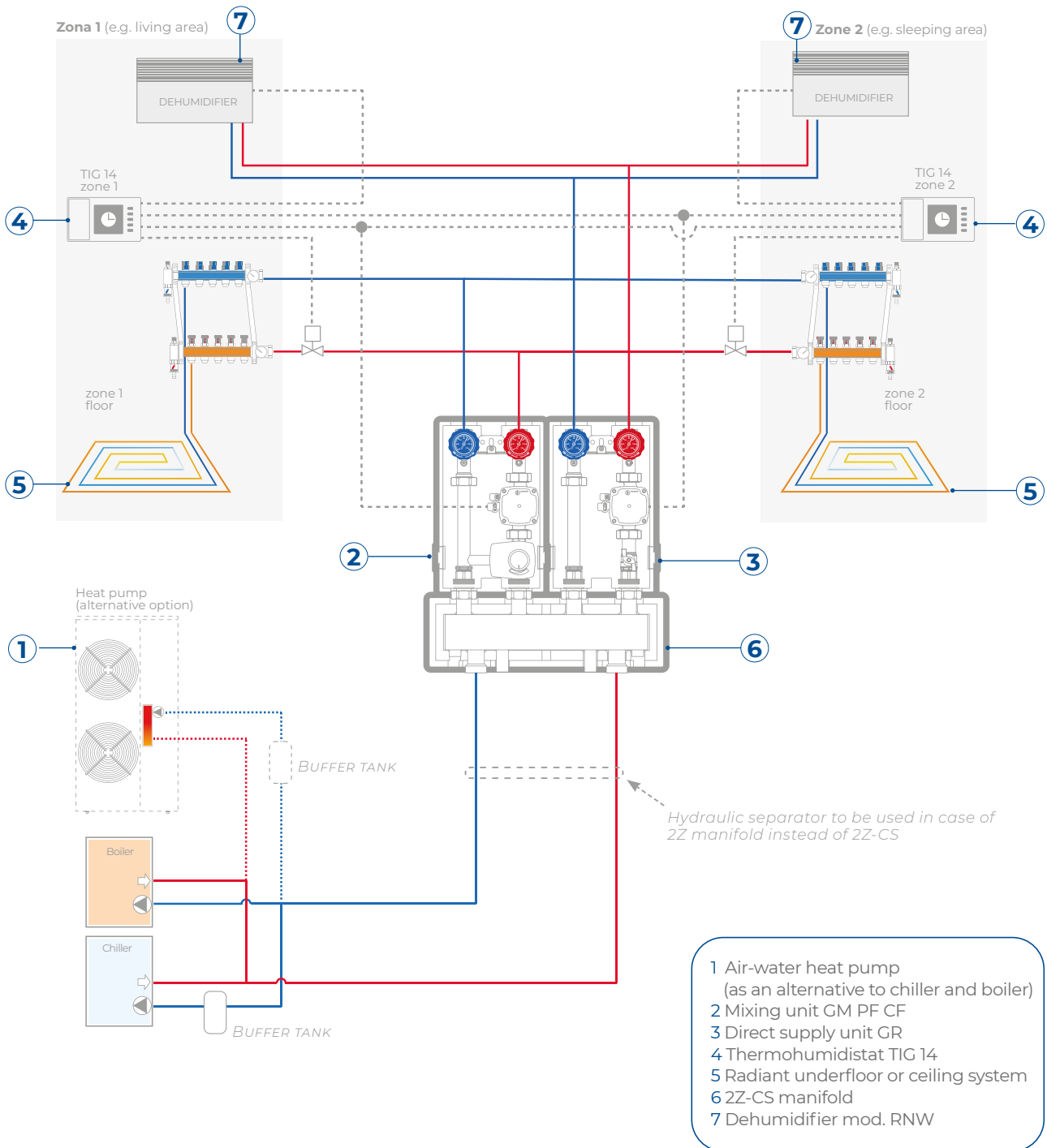

The proposed layout is indicative

HYDRAULIC PERFORMANCES

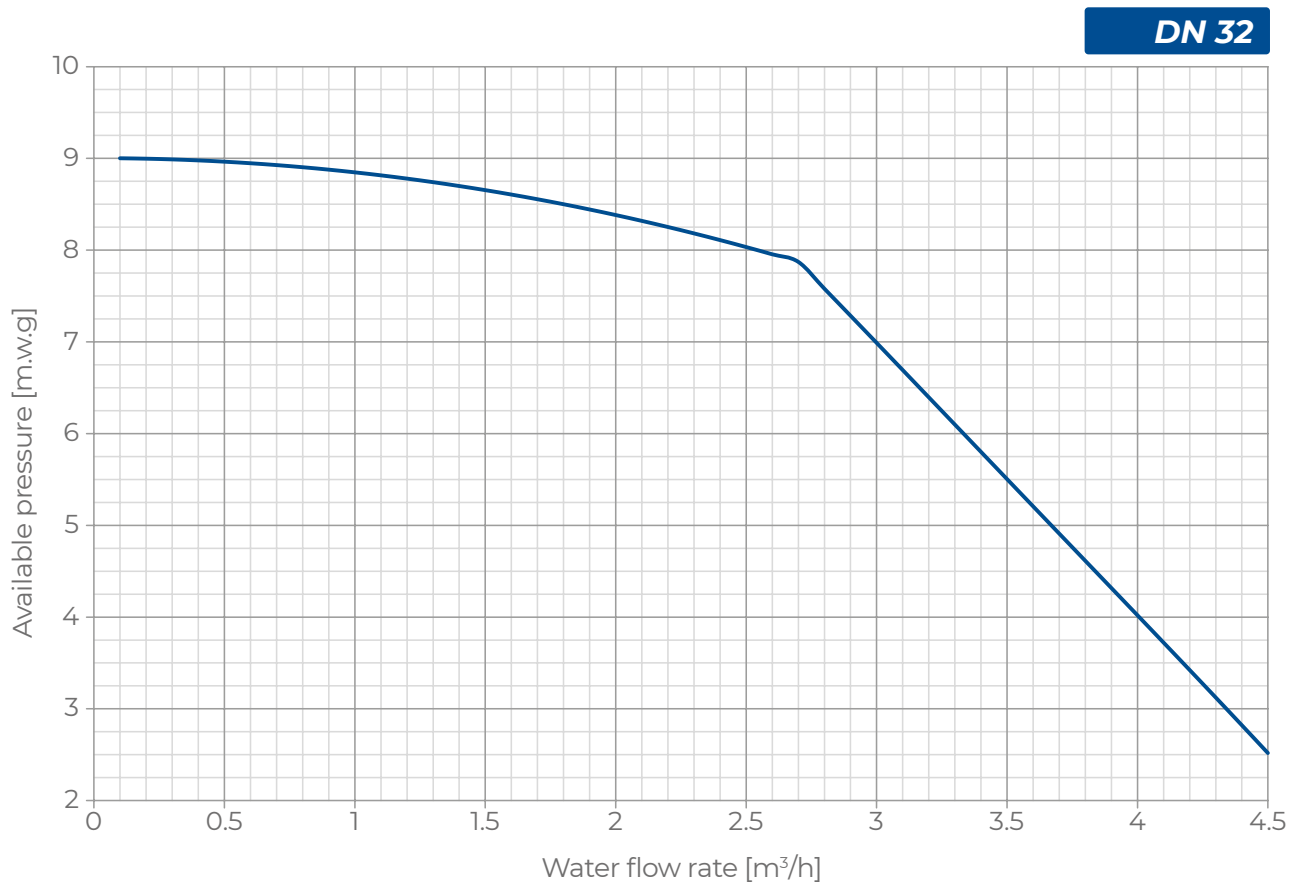
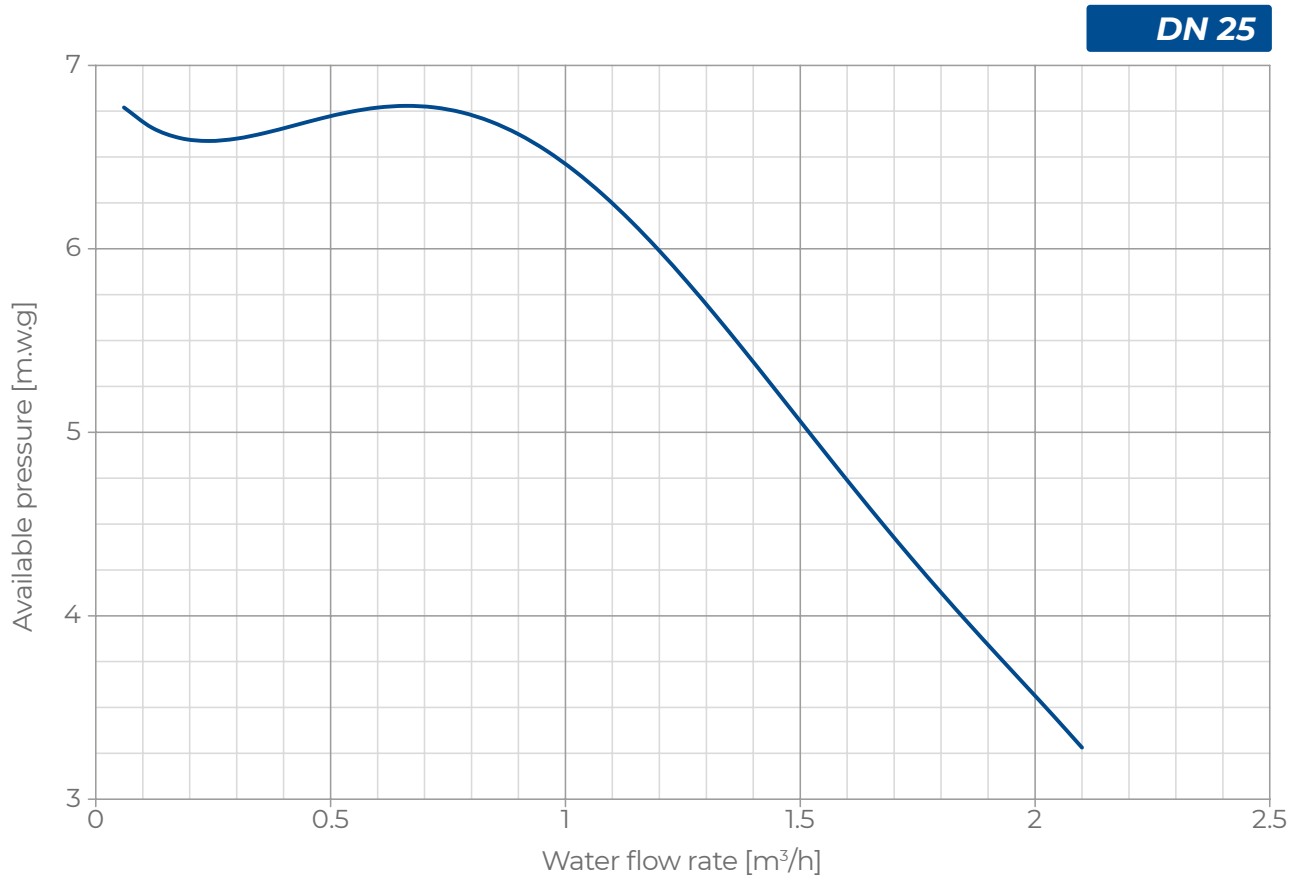



GM VJ mixing unit is a technical room device for the distribution of the thermovector fluid in radiant underfloor, ceiling and wall heating and cooling systems.

The supply temperature is regulated by a mixing valve controlled by a 24 V servomotor driven by 0-10 signal. Inside the unit there is a high-efficiency electronic circulator with variable flow rate and head that ensures low electrical consumption.

The unit is completed with two shut-off valves with thermometers respectively installed on the supply and return lines of the system, an insulating shell made of PPE and a non-return valve to prevent undesired circulation inside the systems with a forced-opening device.

The mixing unit can also be mounted in a multiple version on a wall-mounted manifold. GM VJ can be controlled with an external control unit mod. RDZ Wi or Trio Plus.

FEATURES

- Modulating mixing valve
- Servomotor with 0-10 to 24V signal
- Electronic circulator with variable flow rate and head
- Hydraulic connections Ø 1" M generator side and Ø 1" F system side (DN 25)
- Hydraulic connections Ø 1¼" M generator side and Ø 1¼" F system side (DN 32)
- Hydraulic connection centre distance: 125 mm
- Maximum temperature: 95 °C
- Maximum operating pressure: 8 bar
- Supply voltage: 230V - 50 Hz
- Water flow rate: 2000 l/h with 3.5 m.w.g. (DN 25)
- Water flow rate: 4000 l/h with 4 m.w.g. (DN 32)

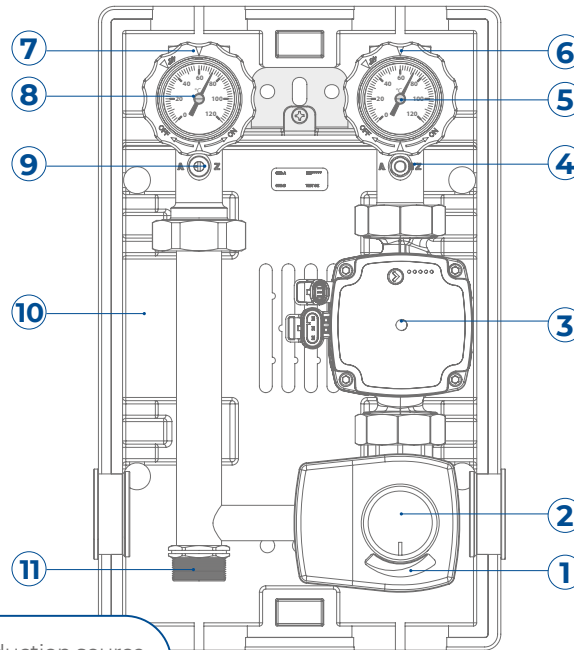

- 1 Water inlet from water production source
- 2 Mixer with 24V electronic servomotor and 0-10 V signal
- 3 Circulator
- 4 Probe/safety thermostat holder
- 5 Supply water thermometer with ball valve
- 6 Water supply to the system
- 7 Water return from the system
- 8 Return thermometer with ball valve and non-return valve
- 9 Device for forcing normally open non-return valve
- 10 PPE insulating shell
- 11 Water return to water production source

DN	CODE
25	3800110
32	3800140

Technical data	Unit	GM VJ DN 25	GM VJ DN 32	
Hydraulic circuit	Max Flow Rate	l/h	2000 4000	
	Mixer Kvs		13 17	
	Max Temperature	°C	95	
	Max Pressure	Bar	8	
	Liquid		Water / Water + glycol max 30%	
Electrical characteristic	Power supply voltage		230 V – 50 Hz	
	Max electrical absorption	W	63	151
Mechanical characteristics	Shut-off valves		DN 25	DN 32
	Generator side connections		1"	1" ¼
	System side connections		1"	1" ¼
	Distance between connections	mm	125	
	Dimensions l x h x p	mm	250x400x210	
	Weight	kg	5.4	5.7

Example of thermoregulation with the use of GM VJ unit

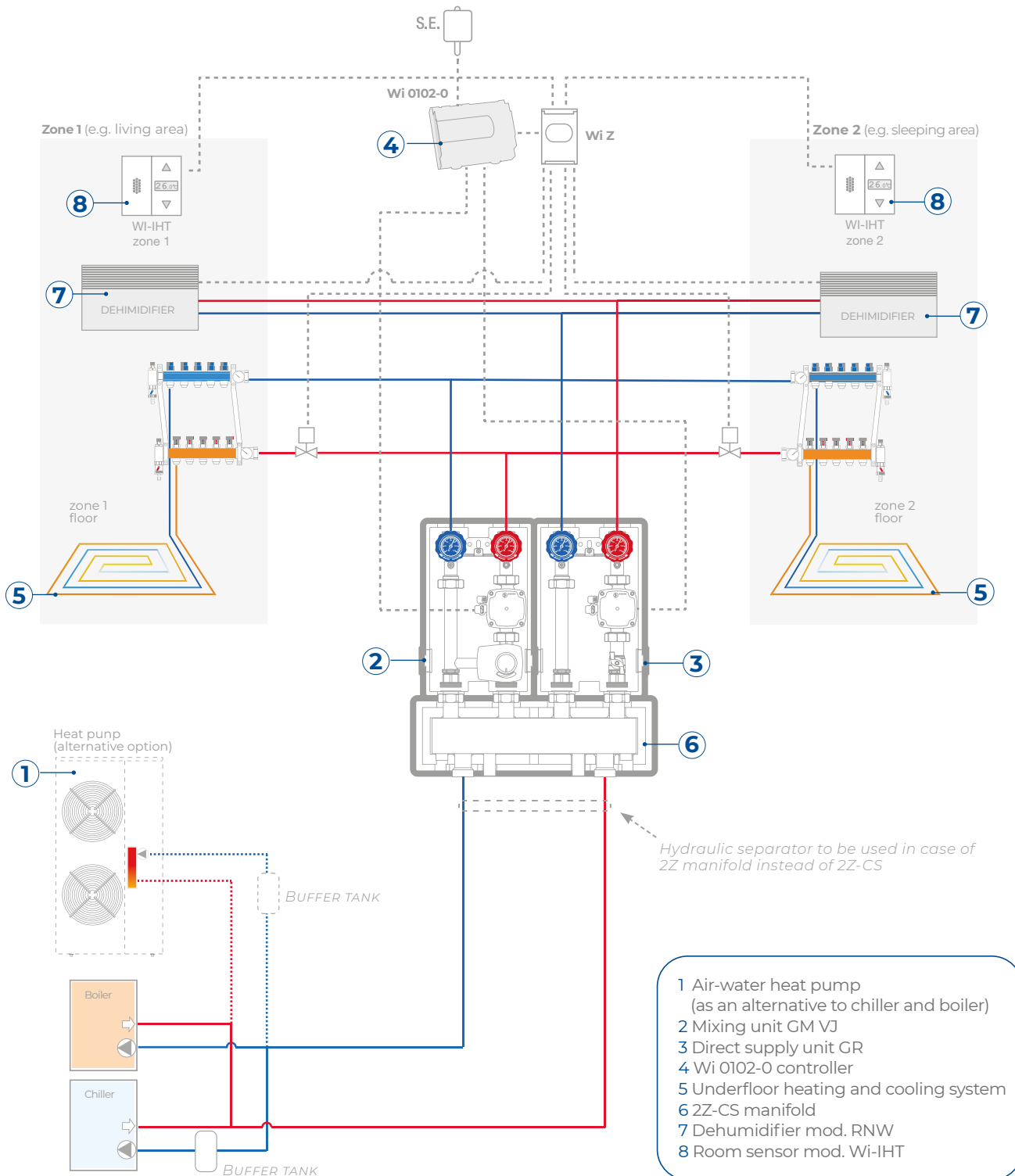

The proposed layout is indicative

■ HYDRAULIC PERFORMANCES

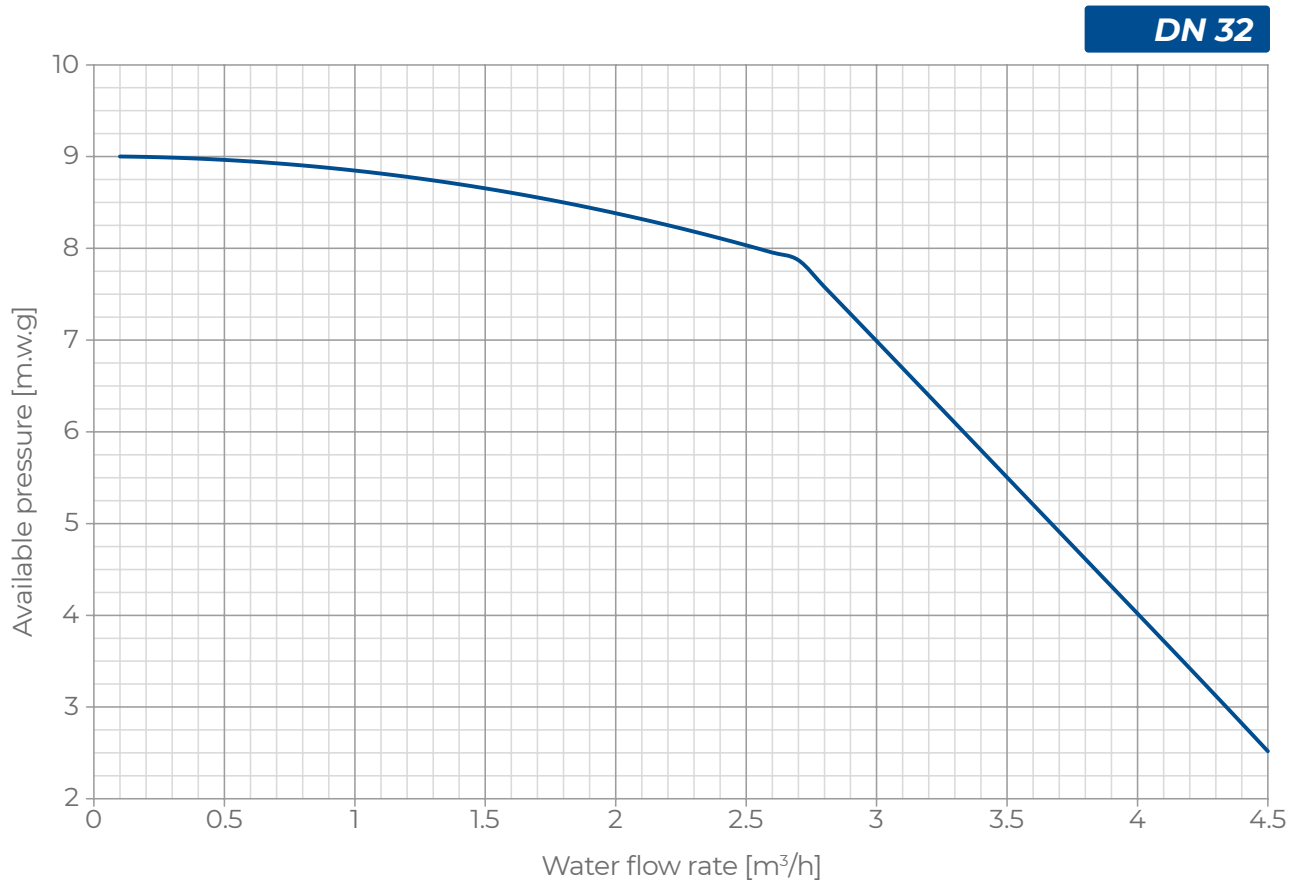
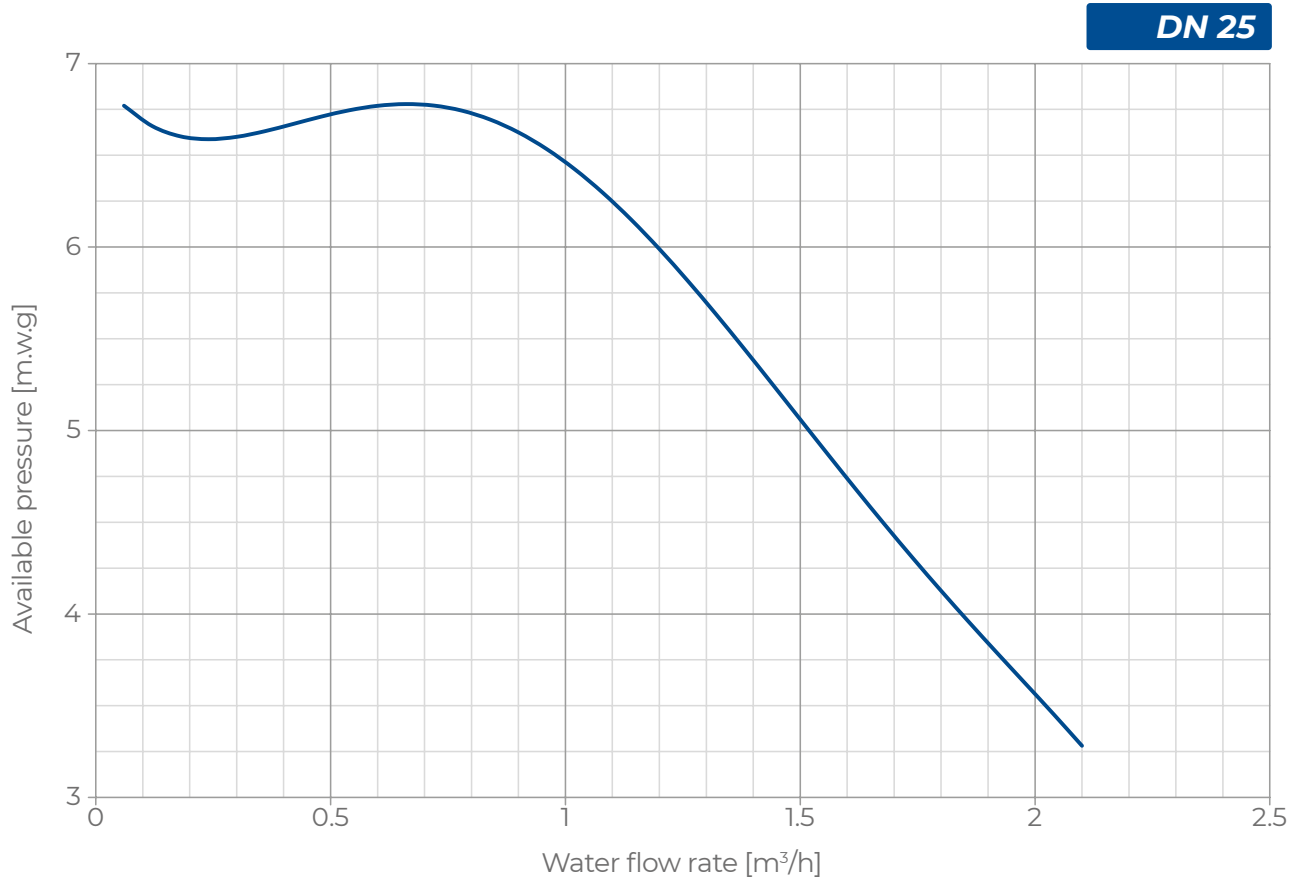

GM 3-POINT MIXING UNIT



GM 3-POINT mixing unit is a technical room device for distributing the thermovector fluid in radiant underfloor, ceiling and wall heating and cooling systems.

The flow temperature is regulated by a mixing valve controlled by a 230 V servomotor driven by 3-point signal. Inside the unit there is a high-efficiency electronic circulator with variable flow rate and head that ensures low power consumption.

The unit is completed with two shut-off valves with thermometers respectively installed on the system supply and return, an insulating shell in PPE and a non-return valve to prevent undesired circulation inside the systems with a forced-opening device.

The mixing unit can also be mounted in a multiple version on a wall-mounted manifold. GM 3 points can be controlled with external control unit mod. RDZ Easy Clima SA.

FEATURES

- 3-way mixing valve
- Servomotor with 230V 3-point signal
- Electronic circulator with variable flow rate and head
- Hydraulic connections Ø 1" M generator side and Ø 1" F system side
- Centre distance between hydraulic connections: 125 mm
- Maximum temperature: 95 °C
- Maximum operating pressure: 8 bar
- Supply voltage: 230V - 50 Hz
- Water flow rate: 1500 l/h with 4 m.w.g.

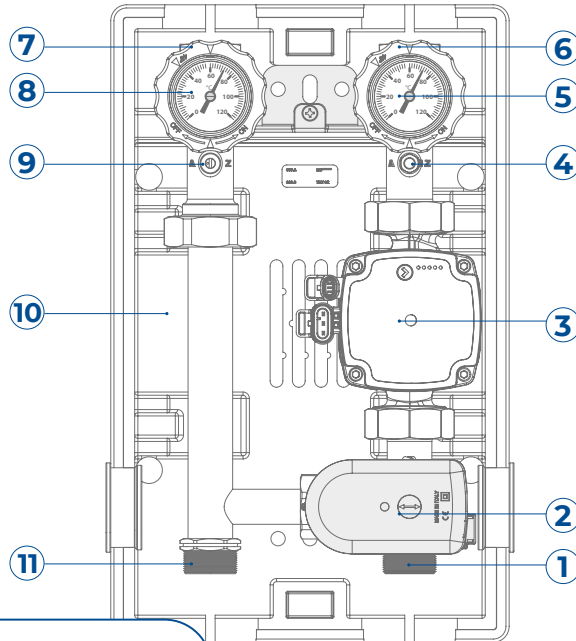

- 1 Water inlet from water production source
- 2 Mixer with 230 V servomotor and 3-point signal
- 3 Circulator
- 4 Probe/safety thermostat holder
- 5 Supply water thermometer with ball valve
- 6 Water supply to the system
- 7 Water return from the system
- 8 Return thermometer with ball valve and non-return valve
- 9 Device for forcing normally open non-return valve
- 10 PPE insulating shell
- 11 Water return to water production source

DN	CODE
25	3800112

Technical data		Unit	3-point
Hydraulic circuit	Max Flow Rate	l/h	1500
	Mixer Kvs		4,5
	Max Temperature	°C	95
	Max Pressure	Bar	8
	Liquid		Water / Water + glycol max 30%
Electrical characteristic	Power supply voltage		230 V – 50 Hz
	Max electrical absorption	W	63
Mechanical characteristics	Shut-off valves		DN 25
	Generator side connections		1"
	System side connections		1"
	Distance between connections	mm	125
	Dimensions l x h x p	mm	250x400x210
	Weight	kg	5,4

Example of thermoregulation with the use of GM 3-point unit

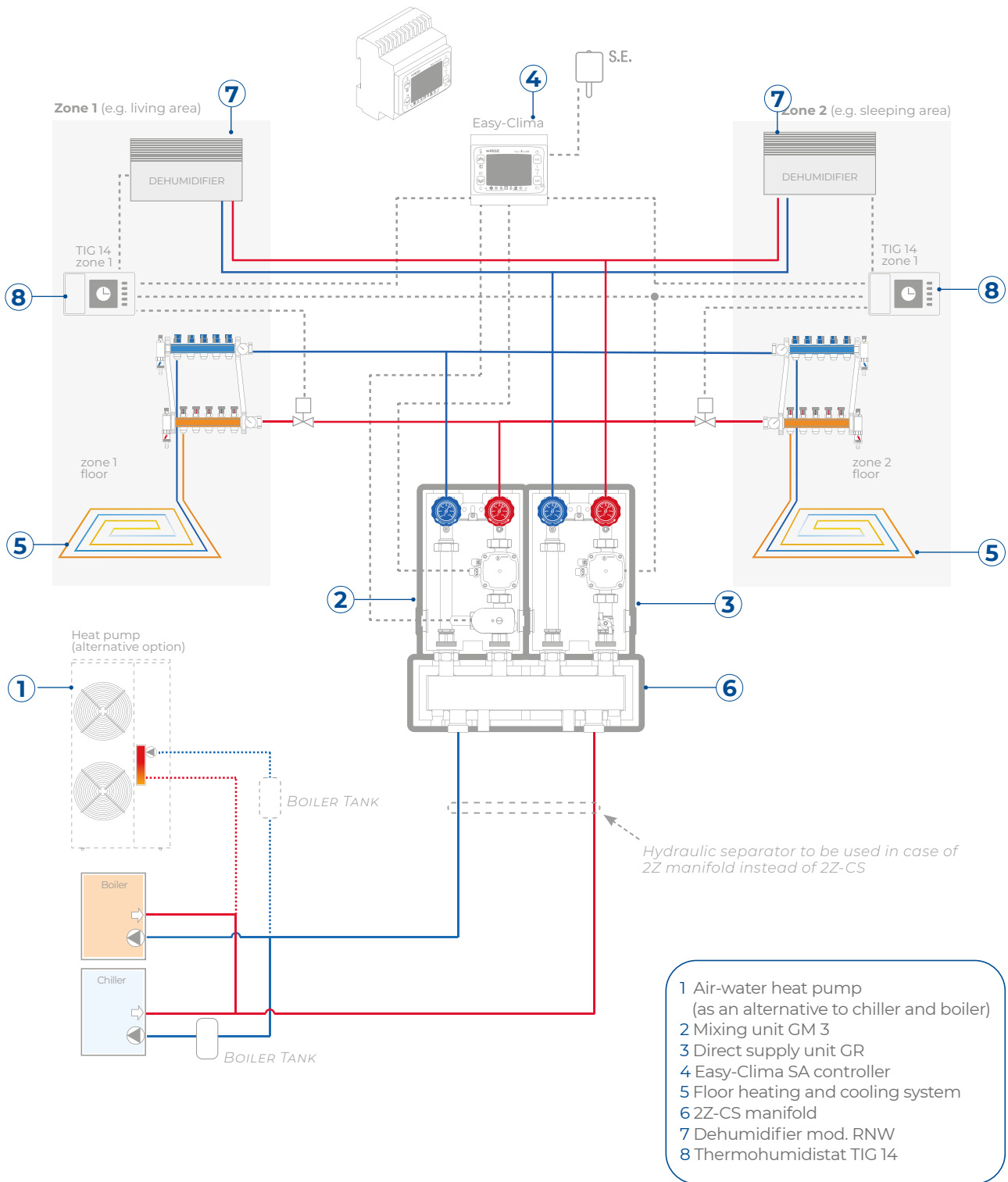

The proposed layout is indicative

■ HYDRAULIC PERFORMANCES

DN 25

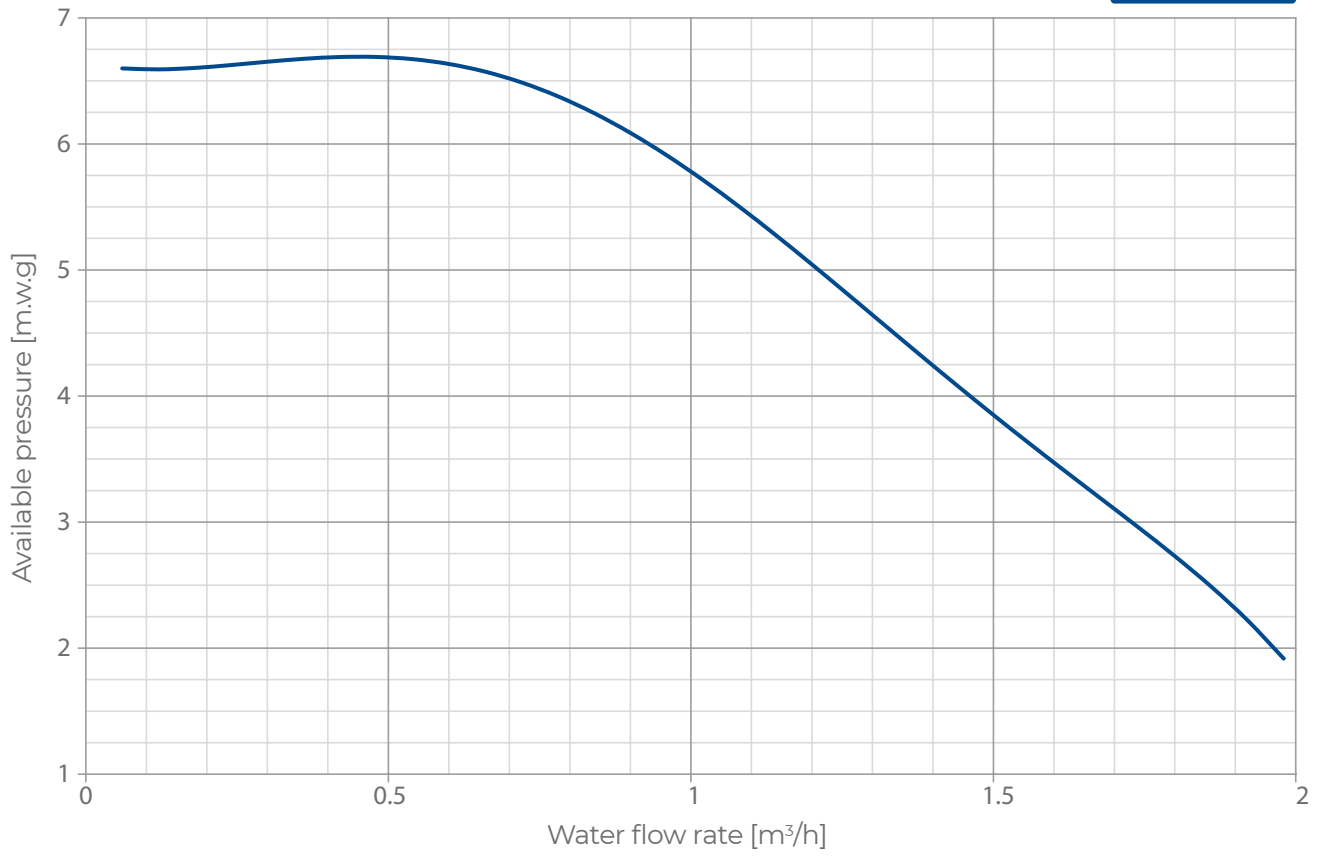



GR direct supply unit is a technical room device for direct non-mixed water supply to manage high temperature systems and dehumidifiers.

The unit features a high-efficiency electronic circulator with variable flow rate and head that ensures low power consumption.

The unit is completed with two shut-off valves with thermometers respectively installed on the supply and return lines of the system, with an insulating shell in EPP and with a non-return valve to prevent undesired circulation inside the systems with a forced-opening device.

FEATURES

- Shut-off ball valve
- Electronic circulator with variable flow rate and head
- Hydraulic connections \varnothing 1" M generator side and \varnothing 1" F system side
- Hydraulic connection centre distance: 125 mm
- Maximum temperature: 95 °C
- Maximum operating pressure: 8 bar
- Supply voltage: 230V - 50 Hz
- Water flow rate: 2000 l/h with 3.5 m.w.g. (DN 25)
- Water flow rate: 4000 l/h with 4.0 m.w.g. (DN 32)

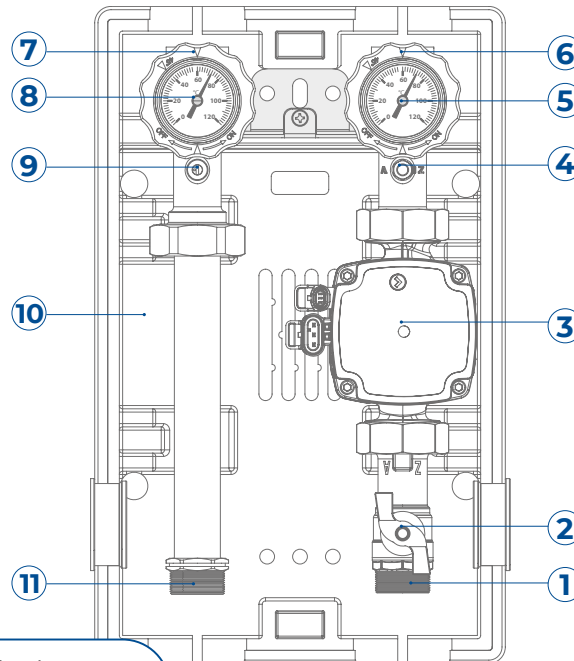

- 1 Water inlet from water production source
- 2 Shut-off ball valve
- 3 Circulator
- 4 Probe/safety thermostat holder
- 5 Supply water thermometer with ball valve
- 6 Water supply to the system
- 7 Water return from the system
- 8 Return thermometer with ball valve and non-return valve
- 9 Device for forcing normally open non-return valve
- 10 PPE insulating shell
- 11 Water return to water heating source

DN	CODE
25	3800100
32	3800105

Technical data	Unit	GR DN 25	GR DN 32	
Hydraulic circuit	Max Flow Rate	l/h	2400 / 4000	
	Mixer Kvs		/ /	
	Max Temperature	°C	95	
	Max Pressure	Bar	8	
	Liquid		Water / Water + glycol max 30%	
Electrical characteristic	Power supply voltage		230 V – 50 Hz	
	Max electrical absorption	W	63	151
Mechanical characteristics	Shut-off valves		DN 25	DN 32
	Generator side connections		1"	1" ¼
	System side connections		1"	1" ¼
	Distance between connections	mm	125	
	Dimensions l x h x p	mm	250x400x210	
	Weight	kg	5.4	5.7

■ HYDRAULIC PERFORMANCES

DN 25

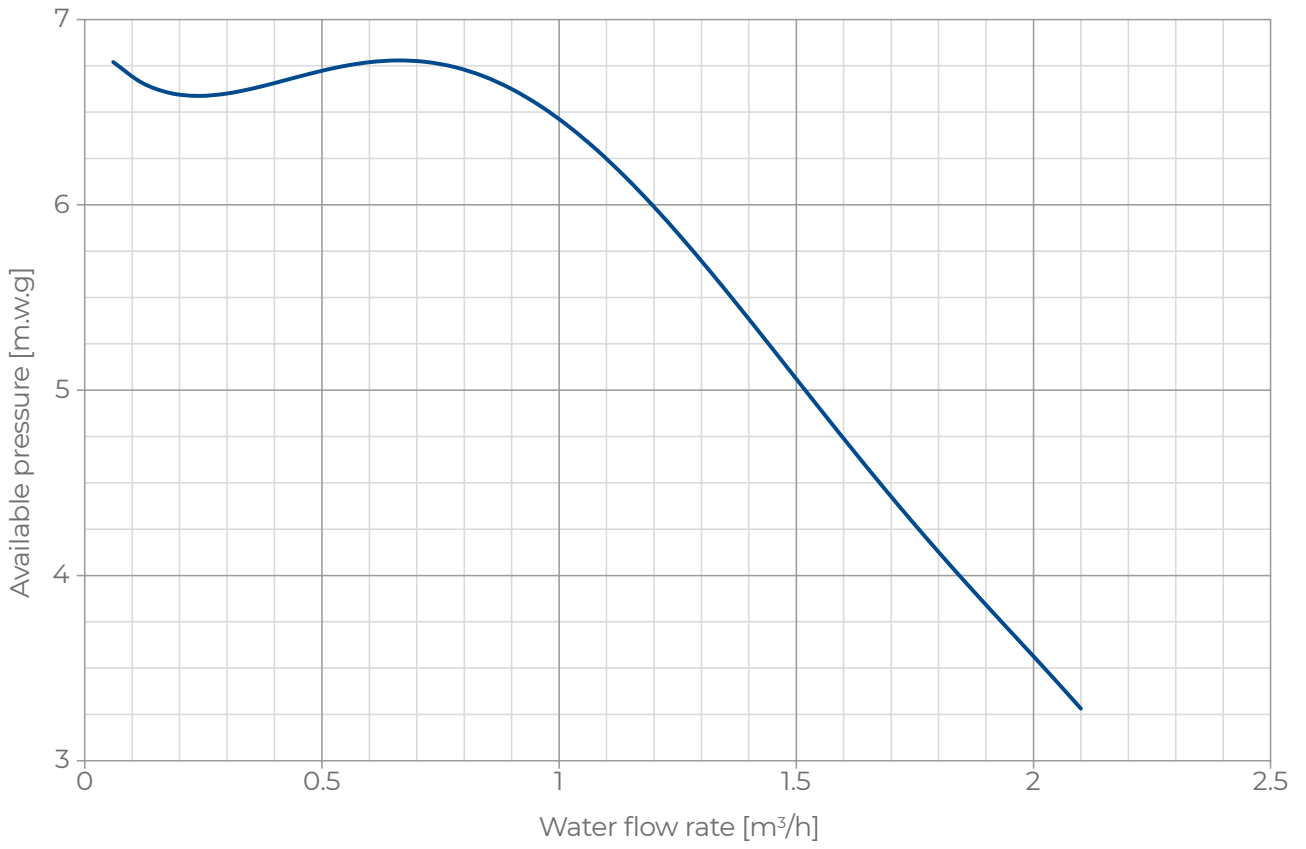

DN 32

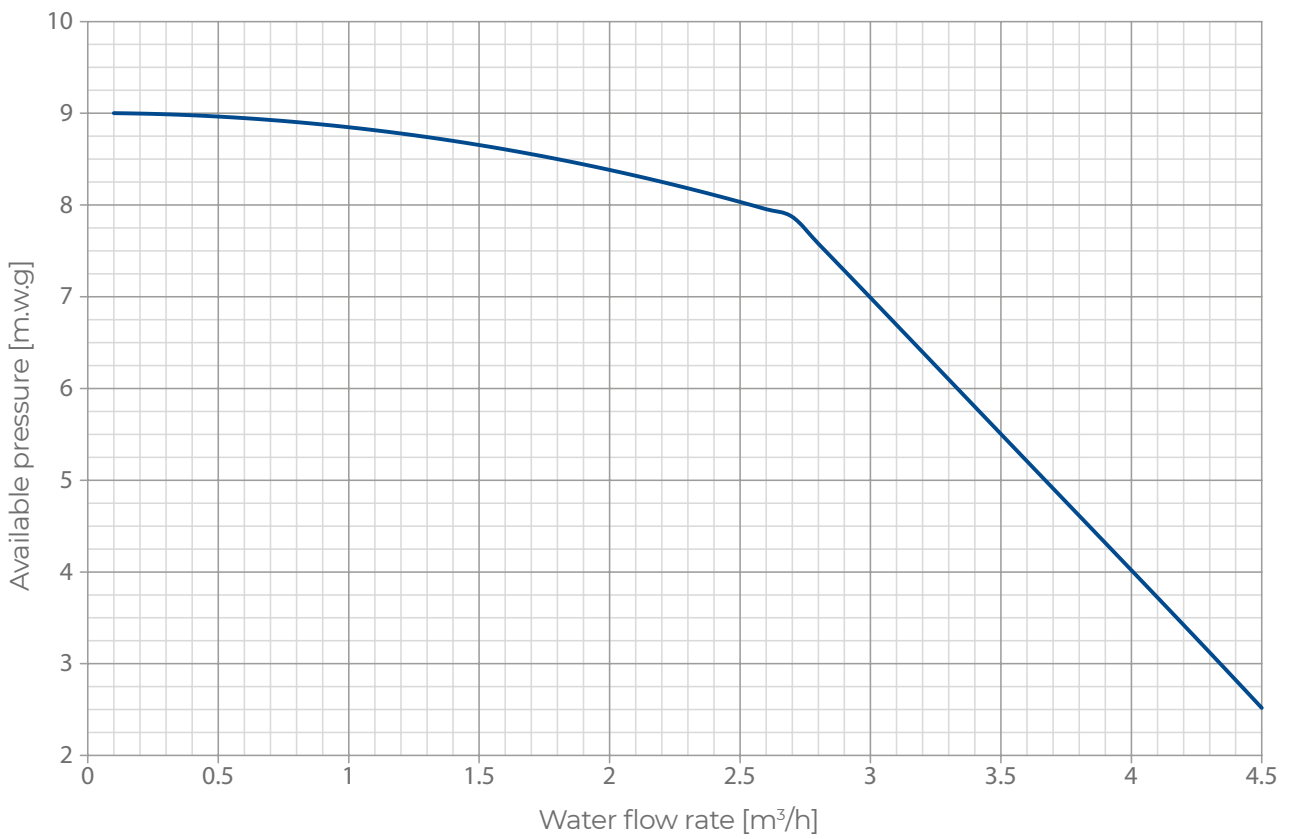

■ ■ ACCESSORIES FOR GM AND GR UNITS

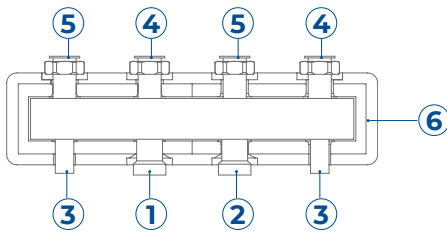

- 1 Water inlet from water production source M 1 1/2"
- 2 Water outlet to water production source M 1 1/2"
- 3 Wall mounting plug
- 4 System water supply F 1 1/2"
- 5 System water return F 1 1/2"
- 6 Insulating shell

Z Manifolds

Distribution manifolds for GM mixing units and/or GR direct supply unit. Their easy installation helps the arrangement of the boiler room. They shall be used if there is a tank acting as hydraulic separator. The manifold consists in a steel body with Ø 1" 1/2 M hydraulic connections on the boiler side and 1" 1/2 F on the system side. The heat generator is connected to the bottom, whereas 2 hydraulic units can be connected to the secondary circuit on the top through specific adapters. The manifold is equipped with PPE insulating shell to prevent condensation and minimise heat loss. Brackets and gaskets are supplied as standard. Connection adapters for GM and GR units shall be purchased separately.

- Max water flow-rate: 4500 l/h
- Max power: (ΔT 15 K): 78 kW

MODEL	OUTLETS	SIZE LXHXP	CODE
2Z	2	545x175x170 mm	3800522
3Z	3	795x175x170 mm	3800523
4Z	4	1045x175x170 mm	3800524

Caution: the inlets and outlets on the central heating side on 3Z manifolds must be inverted with respect to the other 2 models.

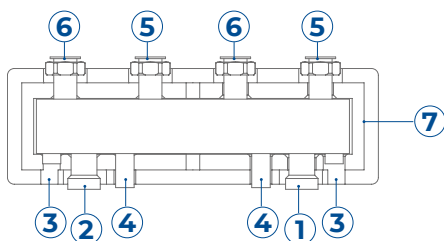

- 1 Water inlet from water production source M 1 1/2"
- 2 Water outlet to water production source M 1 1/2"
- 3 Connections for installation of sensors and filling/draining tap F 1/2"
- 4 Wall mounting plugs
- 5 System water supply F 1 1/2"
- 6 System water return F 1 1/2"
- 7 Insulating shell

Z-CS Manifold

Distribution manifolds for GM mixing units and/or GR direct supply unit, provided with the hydraulic separator. Their easy installation helps the arrangement of the boiler room. The unit can be connected directly with the boiler or with the chiller if they are equipped with their own circulation pump. The manifold consists in a steel body with Ø 1" 1/2 M hydraulic connections on the boiler side and 1" 1/2 F on the system side. The heat generator is connected to the bottom, whereas 2 hydraulic units can be connected to the secondary circuit on the top through specific adapters. The manifold is equipped with PPE insulating shell to prevent condensation and minimise heat loss. Brackets and gaskets are supplied as standard. Connection adapters for GM and GR units shall be purchased separately.

- Max water flow-rate: 4500 l/h
- Max power: (ΔT 15 K): 78 kW

MODEL	OUTLETS	SIZE LXHXP	CODE
2Z-CS	2	545x195x170 mm	3800504
3Z-CS	3	795x195x170 mm	3800505
4Z-CS	4	1045x195x170 mm	3800506

Example of system with ZZ collector and water taken from technical storage tank

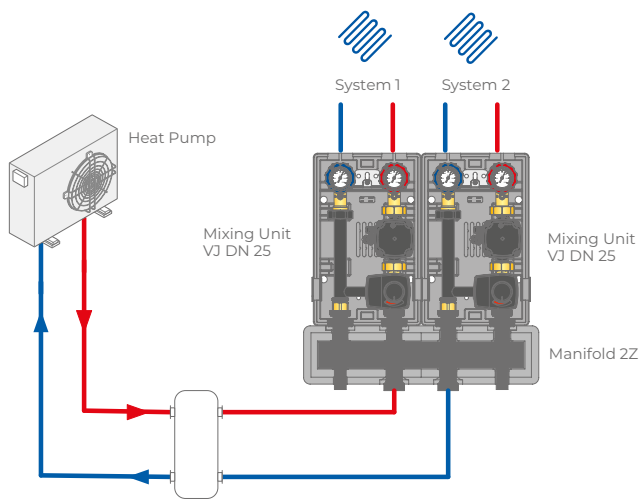

System example with ZZ-CS manifold and water directly supplied from heat pump

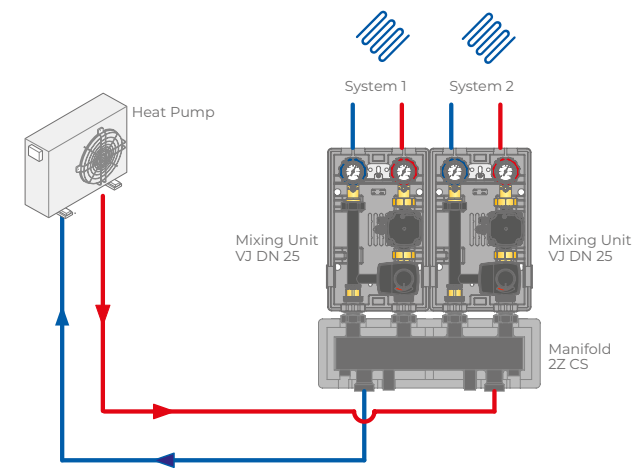

The proposed layouts are only indicative



Adapters

Pair of adapters for the hydraulic connection between mixing unit or direct supply unit and central distribution manifolds mod. Z and Z-CS.

MODEL	CODE
DN 25	3800525
DN 32	3800530

OPTIONAL FOR GM AND GR UNITS



Safety thermostat

Safety contact thermostat to set the maximum water temperature for GM mixing units and GR direct supply unit. The pump blocks if water supply temperature exceeds the set value.

CODE
3800902



Mixing Box is a thermoregulation device for radiant heating and cooling underfloor systems.

In particular, it is a hydraulic substation composed by a series of modules that mix and relaunch the thermovector fluid towards the emitting devices, including radiant underfloor systems, dehumidification units, air handling units and hydronic post-treatment batteries.

The direct supply units (GR), mixing units with thermostatic fixed point valve (PF) or mixing units with electronic mixing valve (VJ) are available in different combination in order to satisfy the multiple needs, and are inserted in a painted steel cabinet, available for recessed or wall installation. The mixing box is completed by an hydraulic separator with automatic vent valve, switchboard for electrical connections, thermal and anti-condensation shell, supply and return thermometers, high efficiency circulation pumps, thermostatic mixing valves (heating only) or 0-10V mixing valves for only heating or heating/cooling systems.

FEATURES

- Available in multiple configurations of directly supply units, fixed point mixing units and electronic modulation mixing units, in order to satisfy several needs
- Hydraulic connections (DN 15), Ø 3/4" M boiler side, Ø 3/4" F system side
- Hydraulic connections centre distance: 70 mm
- Kv hydraulic separator on water production side: 6.7 (2900 l/h with 2 m w.g. pressure drop)
- Water flow rate GR: 2100 l/h with 2 m w.g. of available pressure
- Water flow rate PF: 1300 l/h with 2 m w.g. of available pressure
- Water flow rate VJ: 1900 l/h with 2 m w.g. of available pressure
- Cabinet dimensions: 450x500x160 mm



Components

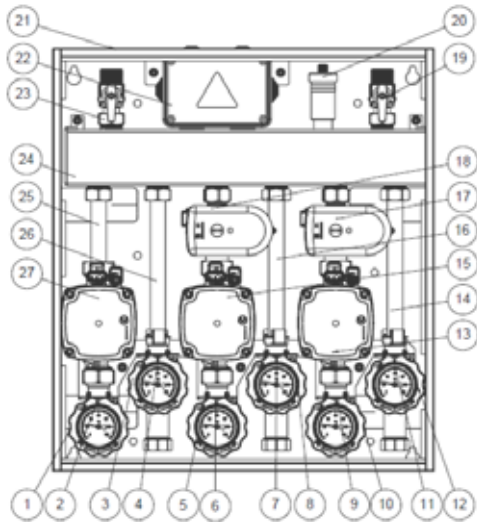

- | | |
|--------------------------|-------------------------------------|
| 1 Supply valve 1 | 15 Pump for zone 2 |
| 2 Probe holder supply 1 | 16 Return pipe zone 2 |
| 3 Return valve 1 | 17 Mixing valve zone 3* |
| 4 Probe holder return 1 | 18 Mixing valve zone 2* |
| 5 Supply valve 2 | 19 Return valve for primary circuit |
| 6 Probe holder supply 2 | 20 Air vent valve |
| 7 Return valve 2 | 21 Steel cabinet |
| 8 Probe holder return 2 | 22 Switchboard |
| 9 Supply valve 3 | 23 Supply valve for primary circuit |
| 10 Probe holder supply 3 | 24 Hydraulic separator |
| 11 Return valve 3 | 25 Supply pipe zone 1 |
| 12 Probe holder return 3 | 26 Return pipe zone 1 |
| 13 Pump for zone 3 | 27 Pump for zone 1 |
| 14 Return pipe zone 3 | |

*If present, it can be electric or thermostatic, basing on the model

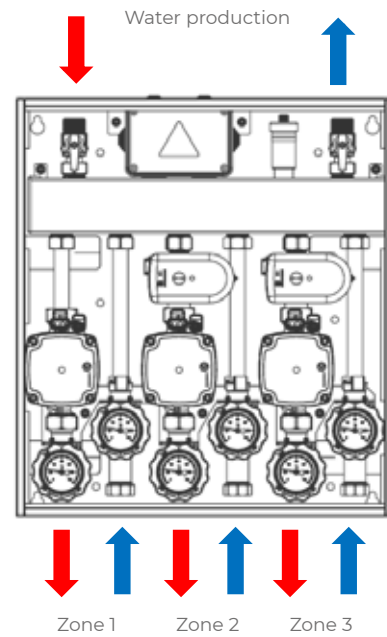

Connections



MIXING BOX GR - PF - VJ

model	dimensions l x h x p (cm)	weight (kg)	code
1 GR - 1 PF	450x500x160	17.0	380GRPF00
2 GR - 1 PF	450x500x160	20.4	380GRGRPF
1 GR - 2 PF	450x500x160	20.6	380GRPFPF
2 PF	450x500x160	17.2	380PFPF00
3 PF	450x500x160	20.8	380PFPFPF
1 GR - 1 VJ	450x500x160	17.1	380GRVJ00
2 GR - 1 VJ	450x500x160	20.5	380GRGRVJ
1 GR - 2 VJ	450x500x160	20.8	380GRVJVJ
2 VJ	450x500x160	17.4	380VJVJ00
3 VJ	450x500x160	21.1	380VJVJVJ
2 GR	450x500x160	16.8	380GRGR00
3 GR	450x500x160	20.2	380GRGRGR

MIXING BOX

Technical data	General features	GR Direct Supply Unit	PF Thermostatic Mixing Unit	VJ Electronic Mixing Unit
Circulation pump		GRUNDFOS UPM3 Hybrid 15-7 130mm - 1" Erp Ready		
Available pressure		7 mt		
Control		* PWM - PP - CP - CC - AA		
Max. temperature		95 °C continuous - 110° peak		
Power supply		230V / 50 Hz		
Max. power consumption		52 W		
Mixing valve		/	VTA 352	NVC3
Control		/	Thermostatic	0-10
kWs		/	2,3	3,6
Regulation range		/	20 °C - 55 °C	/
Power supply		/	/	24V ac/dc
Max. power consumption		/	/	5 W
IP class		/	/	IP 40
Hydraulic separator	NVS01			
Max. number of zones	3			
Connections	3/4" M - DN20			
Section	4.000 mm ² - DN 50			
Volume	1,5 lt			
Max. ΔT zone supply	± 2 °C			
Max. pressure	6 bar			
Material	Fe 58			
Finishing	Black painted			
Max. water supply		***2.100 lt/h	***1.300 lt/h	***1.900 lt/h
Max. temperature		95 °C continuous - 110 °C peak		
Min. temperature		5 °C		
Max. pressure		**4,5 bar - 3 bar with security valve on water production side		
Available pressure at 1000 lt/h		6,4 m w.g.	3,8 m w.g.	6,2 m w.g.
Power exchanged at ΔT 5°C		***10 kW	***7 kW	***10 kW
Power exchanged at ΔT 10°C		***20 kW	***14 kW	***20 kW
Power exchanged at ΔT 15°C		***30 kW	/	/
Power exchanged at ΔT 20°C		***35 kW	/	/
Fluid		Water		
One-way valve		√	√	√
P non-return valve opening		ΔP: 2kPa (200 mm w.g.)		
Thermometer calibration range		0 °C - 120 °C		
IP protection	IPX 0	/		
Finishing	White painted	/		
Size		DN 15		
Boiler side connections	3/4" M			
System side connections		3/4" F		
Centre distance		70 mm	70 mm	70 mm
External dimensions	450x500x160			
Empty weight	10 kg	3,4 kg	3,6 kg	3,7 kg
Water content	1,5 lt	0,3 lt	0,3 lt	0,3 lt
Conformity	Product compliant to: EN 16297-2 / EN 16297-3: 2012 Erp Ready Direttiva PED-2014/68/UE			 
<p>* PWM : external control via PWM, profilo A or C mode PP: Proportional Pressure - CP: Costant Pressure - CC: Constant Curve - AA: AUTOADAPT ** Check the calibration of the security valve on water production and/or sytem side *** With residual head of 2 m w.g.</p>				

MIXING BOX PERFORMANCES

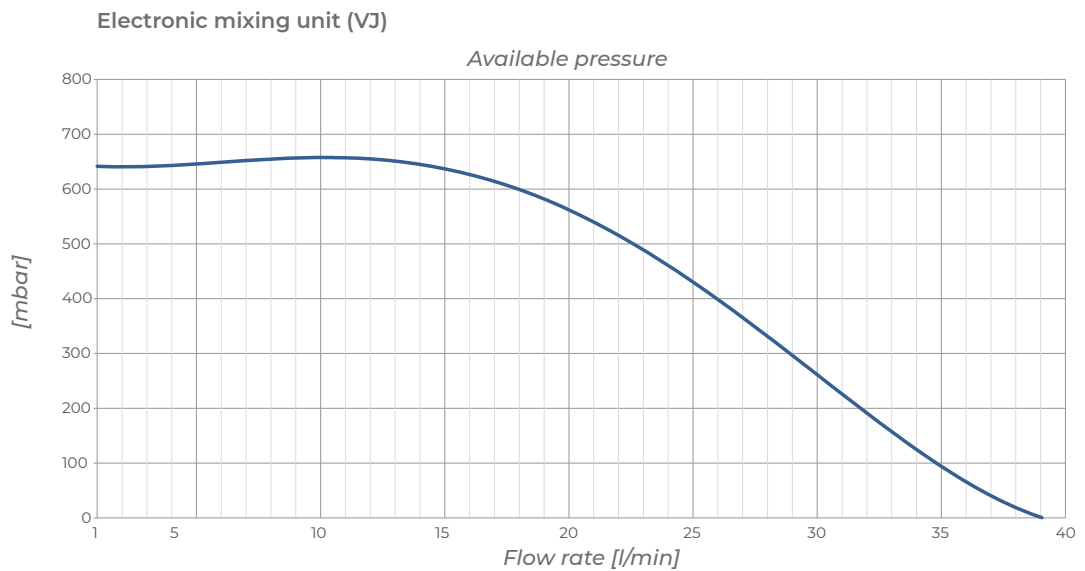
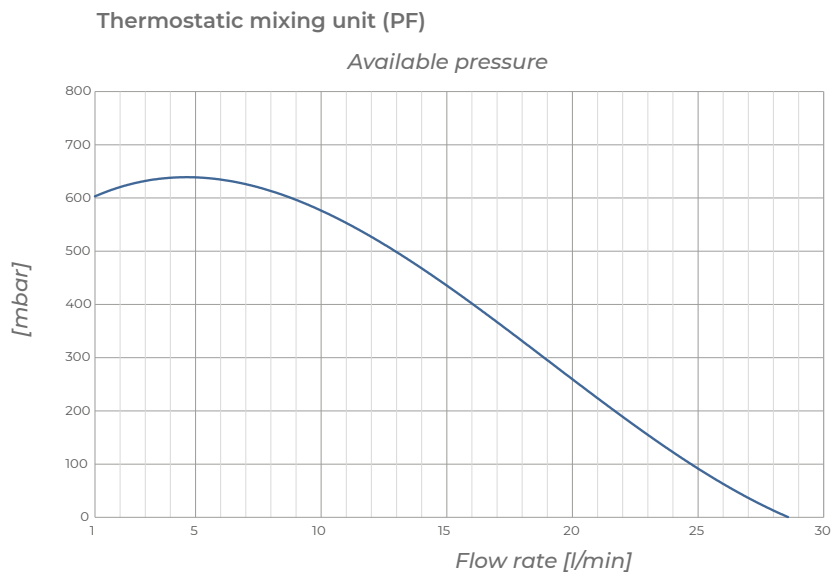
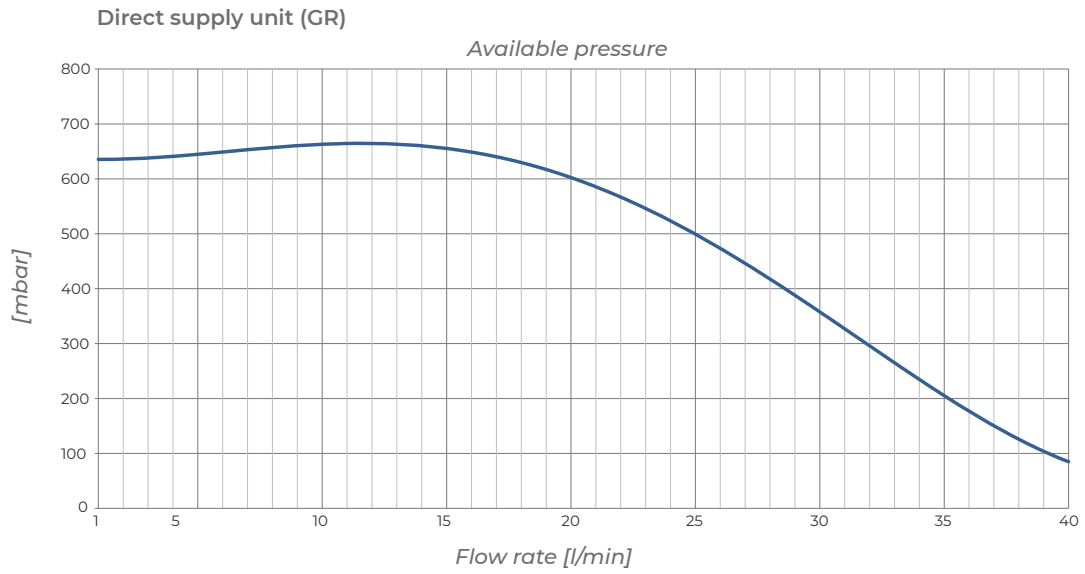

PF THERMOREGULATION KIT



The Kit is a device that includes in a single product, suitable for installation in room, the radiant distribution part (underfloor system), temperature control and high temperature outlets for connecting up to 3 radiators. The **PF** version, in particular, is suitable for managing heating only.

It is complete with zinc-plated steel cabinet with adjustable feets, brackets, protective cover for plaster, white door with lock, adjustable frame, water production-side by-pass, a 3-way mixing valve with thermostatic control and adjustment range up to 50 °C (heating only), electronic circulator, a micrometric lockshield, one-way valve, shut-off valves, thermometers, balancing lockshield, vent valve and fill/drain valves, connector to the electrical installation and wired system. Optionally, the kit can be equipped with 2 or 3 high temperature outlets, an air trap and a control box with safety devices.

The kit is available with CONTROL series brass manifolds or TOP COMPOSIT series technopolymer manifolds.

FEATURES

- Suitable for connection to water production source with built-in pump
- Control with 3-way mixing valve
- Adjustable thermostatic valve with bulb and capillary
- High efficiency electronic circulator
- Electrical wiring with IP 43 protection
- Electronic safety thermostat (optional)
- Air separator (optional)
- Controllable high temperature outlets for radiators (optional)



- A Fill/drain traps
- B Return manifold
- C Return thermometer
- D Thermostatic element
- E Control unit
- F Mixing valve
- G Pump
- H Adjustment feet
- I Balancing lockshield
- L Supply thermometer
- M Supply manifold
- N Cabinet
- O Adapter for pipe Ø 17
- P Terminal unit
- Q 2 outlets HT manifold
- R 3 outlets HT manifold
- S 3-way air trap
- T PF control board

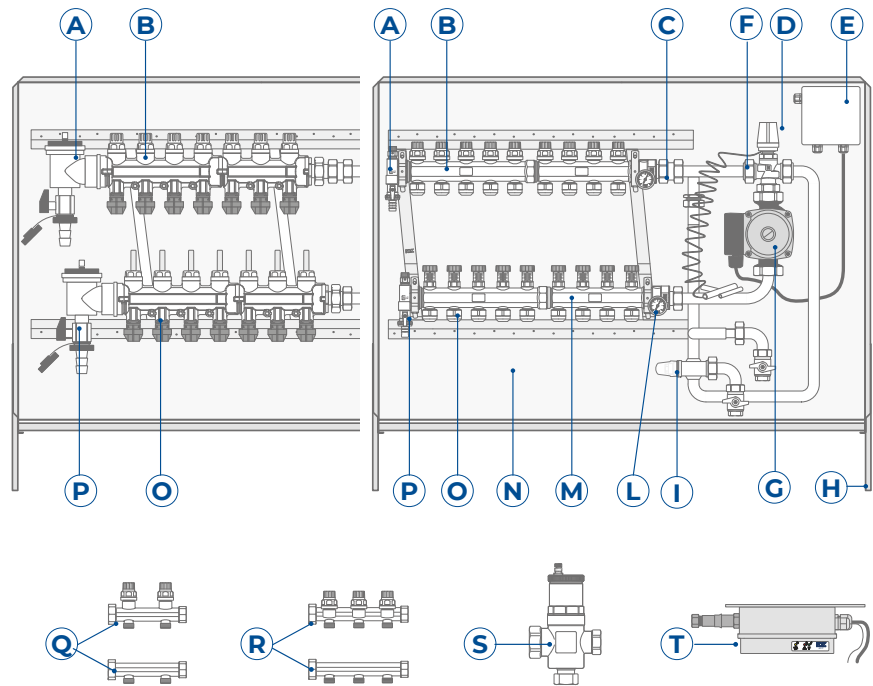

PF Kit with Top Composit manifold

n. outlets	dimensions l x h x p (cm)	code Ø 12	code Ø 16	code Ø 17
3+3	65x83÷89x14.5	3PP03N0BN2	3PP03N0BN6	3PP03N0BN7
4+4	65x83÷89x14.5	3PP04N0BN2	3PP04N0BN6	3PP04N0BN7
5+5	65x83÷89x14.5	3PP05N0BN2	3PP05N0BN6	3PP05N0BN7
6+6	80x83÷89x14.5	3PP06N0BN2	3PP06N0BN6	3PP06N0BN7
7+7	80x83÷89x14.5	3PP07N0BN2	3PP07N0BN6	3PP07N0BN7
8+8	80x83÷89x14.5	3PP08N0BN2	3PP08N0BN6	3PP08N0BN7
9+9	100x83÷89x14.5	3PP09N0BN2	3PP09N0BN6	3PP09N0BN7
10+10	100x83÷89x14.5	3PP10N0BN2	3PP10N0BN6	3PP10N0BN7
11+11	100x83÷89x14.5	3PP11N0BN2	3PP11N0BN6	3PP11N0BN7
12+12	100x83÷89x14.5	3PP12N0BN2	3PP12N0BN6	3PP12N0BN7

PF Kit with Control manifold

n. outlets	dimensions l x h x p (cm)	code Ø 12	code Ø 16	code Ø 17
3+3	65x83÷89x14.5	3PO03N0BN2	3PO03N0BN6	3PO03N0BN7
4+4	65x83÷89x14.5	3PO04N0BN2	3PO04N0BN6	3PO04N0BN7
5+5	65x83÷89x14.5	3PO05N0BN2	3PO05N0BN6	3PO05N0BN7
6+6	80x83÷89x14.5	3PO06N0BN2	3PO06N0BN6	3PO06N0BN7
7+7	80x83÷89x14.5	3PO07N0BN2	3PO07N0BN6	3PO07N0BN7
8+8	80x83÷89x14.5	3PO08N0BN2	3PO08N0BN6	3PO08N0BN7
9+9	100x83÷89x14.5	3PO09N0BN2	3PO09N0BN6	3PO09N0BN7
10+10	100x83÷89x14.5	3PO10N0BN2	3PO10N0BN6	3PO10N0BN7
11+11	100x83÷89x14.5	3PO11N0BN2	3PO11N0BN6	3PO11N0BN7
12+12	100x83÷89x14.5	3PO12N0BN2	3PO12N0BN6	3PO12N0BN7

FOR COMPLETE CODING REFER TO PAGE 223

Example of thermoregulation with PF kit

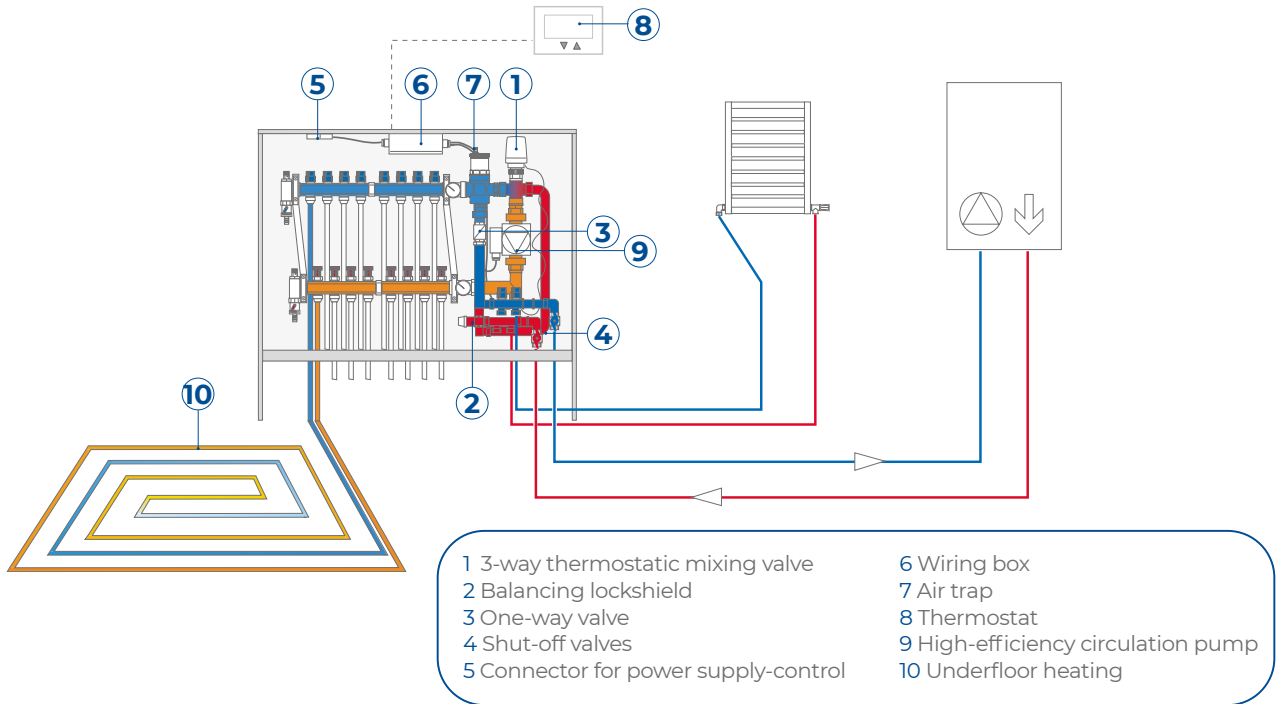

HYDRAULIC PERFORMANCES

(performance of electronic self-regulating circulator)

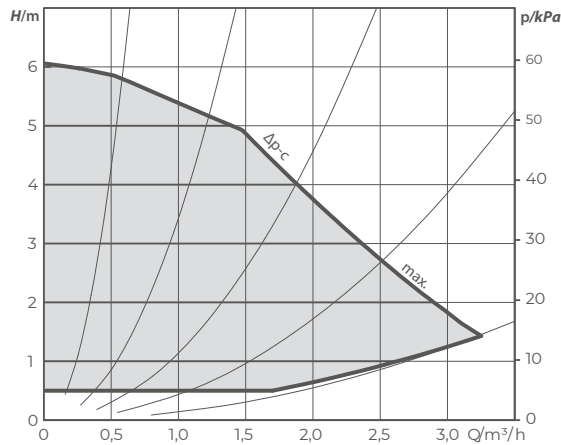

ACCESSORIES FOR PF KIT



Control Box for Kit PF

Pro control box for Kit PF including safety board and max temperature setting at 50 or 55 °C. The pump stops if the inflow temperature is higher than the set value. The alarm is shown by led. Automatic restarting when the temperature is lower than the set value. Input for heat generator (boiler or heat pump) and antisuff device for the pump when the system is not used for a while.

MODEL	CODE
QE Pro	- -

EASY CLIMA TERMOREGULATION KIT



The Kit is a device that includes in a single product, suitable for installation in room, the radiant distribution part (underfloor system), temperature control and high temperature outlets for connecting up to 3 radiators. The **Easy Clima** model, in particular, is suitable for managing both heating and cooling operation.

Low-temperature thermoregulation is achieved with a microprocessor technology climatic control board equipped with a keypad and 4-digit alphanumeric display for programming and setting the parameters. The of operation from winter to summer is manual. The kit can be combined with an external user interface with embedded temperature and humidity probe (Easy-Clima Controller optional), allowing also to control the dehumidifier.

It is complete with zinc-plated steel cabinet with adjustable feets, brackets, protective cover for plaster, white door with lock, adjustable frame, water production-side by-pass, 3-way mixing valve with servomotor, electronic circulator, micrometric lockshield, one-way valve, shut-off valves, thermometers, balancing lockshield, air vent valve and fill/drain valves and electronic safety thermostat. It has an anti-seize pump function and it is fully wired internally.

Optionally, the kit can be equipped with 2 or 3 high temperature outlets, an air trap and an anti-condensation insulation.

The kit is available with CONTROL series brass manifolds or TOP COMPOSIT series technopolymer manifolds.

FEATURES

- Suitable for connection to water production source with built-in pump
- Control with 3-way mixing valve
- Modulating servomotor 0-10V
- Easy-Clima climate control unit with winter and summer management
- High efficiency electronic circulator
- Electrical wiring with IP 43 protection
- Predisposition for Easy-Clima interface
- Controller with temperature/humidity sensor
- Provision for the control of dehumidification and room thermostats
- Electronic safety thermostat
- Air separator (optional)
- Controllable high temperature outlets for radiators (optional)

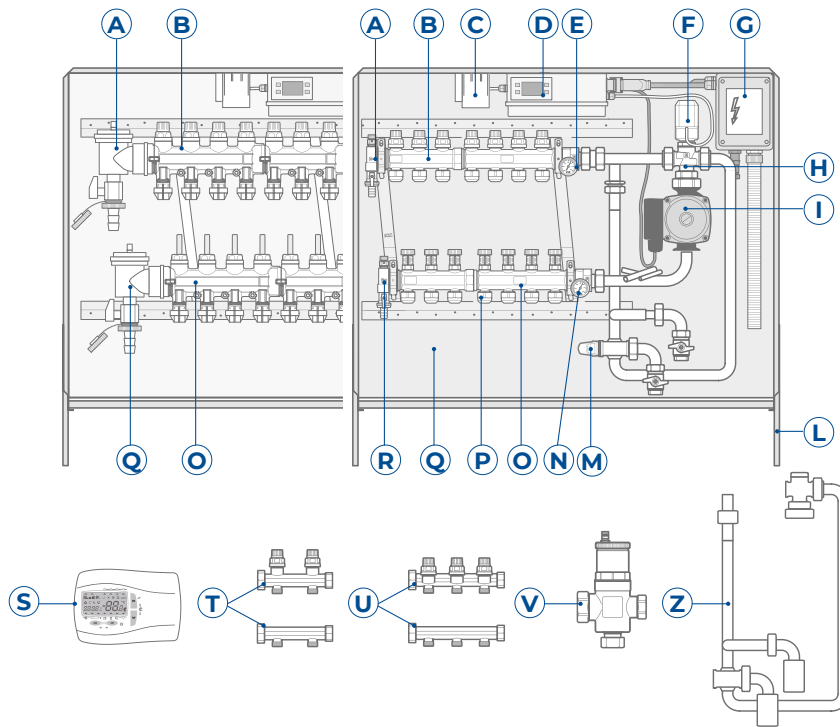

- A Fill/drain taps
- B Return manifold
- C Transformer
- D Control unit
- E Return thermometer
- F Servomotor
- G Junction box
- H Mixing valve
- I Pump
- L Adjustment feet
- M Balancing lockshield
- N Supply thermometer
- O Supply manifold
- P Fittings for Ø 17 mm pipe
- Q Cabinet
- R Terminal unit
- S Easy Clima Controller
- T 2 outlets HT manifold
- U 3 outlets HT manifold
- V 3-way air trap
- Z Anti-condensation insulation kit

Easy-Clima Kit with Top Composit manifold

n. outlets	dimensions l x h x p (cm)	code Ø 12	code Ø 16	code Ø 17
3+3	65x83÷89x14.5	3EP03N0QN2	3EP03N0QN6	3EP03N0QN7
4+4	65x83÷89x14.5	3EP04N0QN2	3EP04N0QN6	3EP04N0QN7
5+5	65x83÷89x14.5	3EP05N0QN2	3EP05N0QN6	3EP05N0QN7
6+6	80x83÷89x14.5	3EP06N0QN2	3EP06N0QN6	3EP06N0QN7
7+7	80x83÷89x14.5	3EP07N0QN2	3EP07N0QN6	3EP07N0QN7
8+8	80x83÷89x14.5	3EP08N0QN2	3EP08N0QN6	3EP08N0QN7
9+9	100x83÷89x14.5	3EP09N0QN2	3EP09N0QN6	3EP09N0QN7
10+10	100x83÷89x14.5	3EP10N0QN2	3EP10N0QN6	3EP10N0QN7
11+11	100x83÷89x14.5	3EP11N0QN2	3EP11N0QN6	3EP11N0QN7
12+12	100x83÷89x14.5	3EP12N0QN2	3EP12N0QN6	3EP12N0QN7

Easy-Clima Kit with Control manifold

n. outlets	dimensions l x h x p (cm)	code Ø 12	code Ø 16	code Ø 17
3+3	65x83÷89x14.5	3EO03N0QN2	3EO03N0QN6	3EO03N0QN7
4+4	65x83÷89x14.5	3EO04N0QN2	3EO04N0QN6	3EO04N0QN7
5+5	65x83÷89x14.5	3EO05N0QN2	3EO05N0QN6	3EO05N0QN7
6+6	80x83÷89x14.5	3EO06N0QN2	3EO06N0QN6	3EO06N0QN7
7+7	80x83÷89x14.5	3EO07N0QN2	3EO07N0QN6	3EO07N0QN7
8+8	80x83÷89x14.5	3EO08N0QN2	3EO08N0QN6	3EO08N0QN7
9+9	100x83÷89x14.5	3EO09N0QN2	3EO09N0QN6	3EO09N0QN7
10+10	100x83÷89x14.5	3EO10N0QN2	3EO10N0QN6	3EO10N0QN7
11+11	100x83÷89x14.5	3EO11N0QN2	3EO11N0QN6	3EO11N0QN7
12+12	100x83÷89x14.5	3EO12N0QN2	3EO12N0QN6	3EO12N0QN7

FOR COMPLETE CODING REFER TO PAGE 223

Example of thermoregulation with EASY CLIMA kit

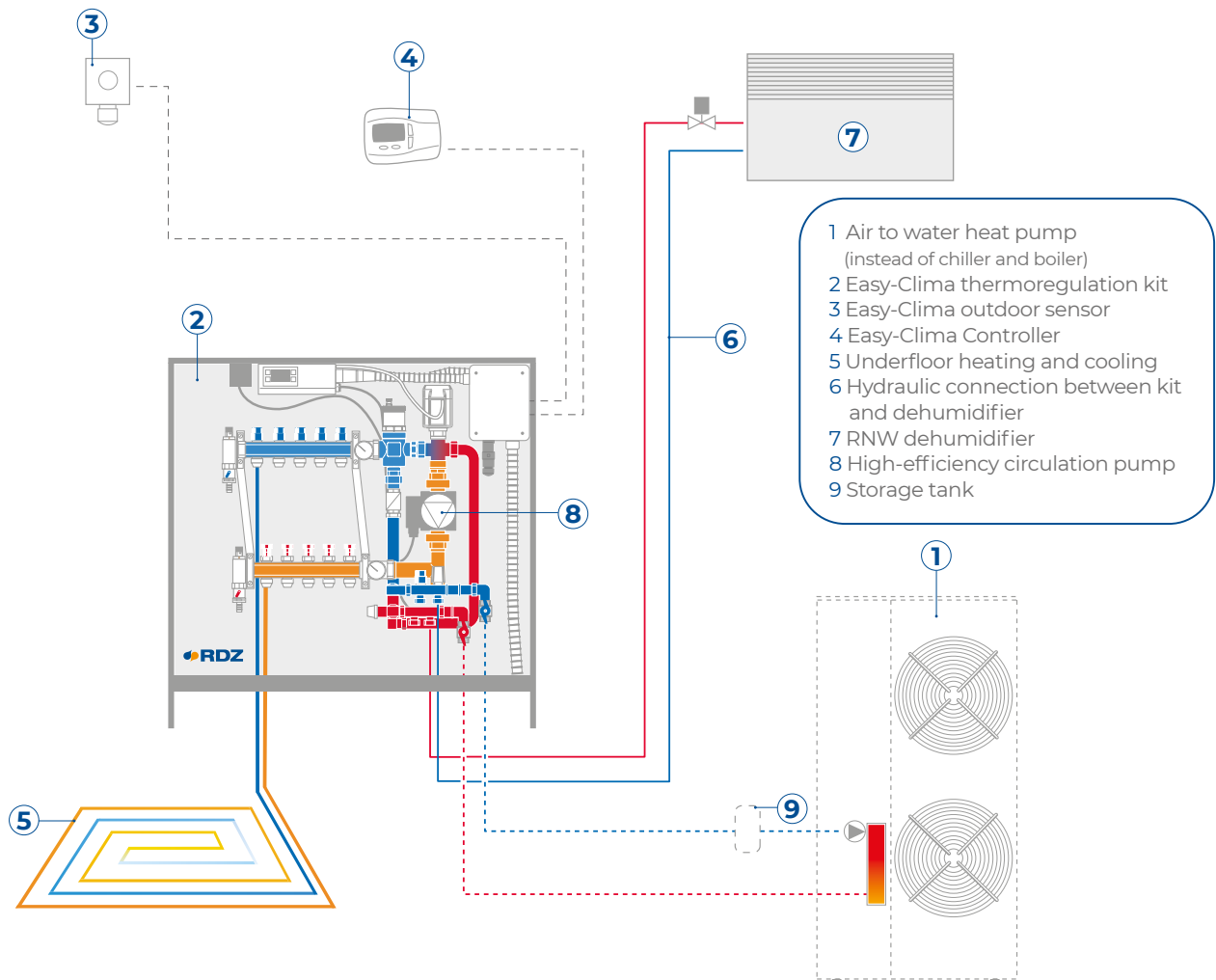

The proposed layout is indicative

■ HYDRAULIC PERFORMANCES

(performance of electronic self-regulating circulator)

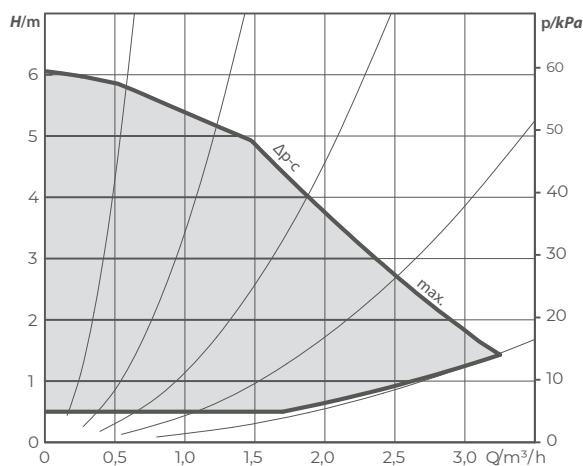

■ ACCESSORIES FOR EASY CLIMA KIT



Anti-condensation Insulation

The anti-condensation insulation is used for each component which can be in contact with cool water in the low-temperature system. It is recommended for summer cooling systems.

MODEL	CODE
For Kit EC	--



Easy-Clima Controller

EASY-CLIMA CONTROLLER is installed in the room and acts as remote control of the information in EASY-CLIMA control unit. Since it is equipped with temperature and humidity sensors, it monitors winter temperature as well as summer temperature and dehumidification. Tension and communication come from EASY-CLIMA controller.

MODEL	CODE
For Kit EC	7301050

VJ 0-10 THERMOREGULATION KIT



The kit is a device that includes in a single product suitable for installation in the room, the radiant distribution part (underfloor system), temperature control and high-temperature units for connecting up to 3 radiators. The **VJ** model, in particular, is suitable for managing system operation in both heating and cooling mode.

It is complete with metal cabinet with adjustable feet, brackets, protective cover for plaster, white door with lock and adjustable frame. Equipped with 3-way mixing valve, 0-10 analogue servomotor (electronic temperature control unit not included), electronic circulator, micrometric lockshield, one-way valve, shut-off valves, thermometers, balancing lockshield, air vent and system load/unload valves, electronic safety thermostat, pump with anti-seize function, connector for external electrical connection and is fully wired internally.

Optionally, the kit can be equipped with high temperature connections (2 or 3 outlets), degasser and anti-condensation insulation.

The kit is available with CONTROL brass or TOP COMPOSIT technopolymer manifolds.

FEATURES

- Suitable for connection to generator with built-in pump
- Control with 3-way mixing valve
- Modulating servomotor 0-10V
- High efficiency electronic circulator
- Electrical wiring with IP 43 protection
- Ready for Wi or Trio Plus control unit
- Electronic safety thermostat
- Air separator (optional)
- Controllable high temperature outlets for radiators (optional)



- A Fill/drain taps
- B Return manifold
- C Power supply/command plugs
- D Control unit
- E Return thermometer
- F Servomotor
- G Mixing valve
- H Mixing valve control plug
- I Pump
- L Adjustment feet
- M Regulation holder
- N Balancing lockshield
- O Supply manifold
- P Cabinet
- Q Adapter for Ø 17 mm pipe
- R Terminal unit
- S 2 outlets HT manifold
- T 3 outlets HT manifold
- U 3-way air trap
- V Anti-condensation insulation kit

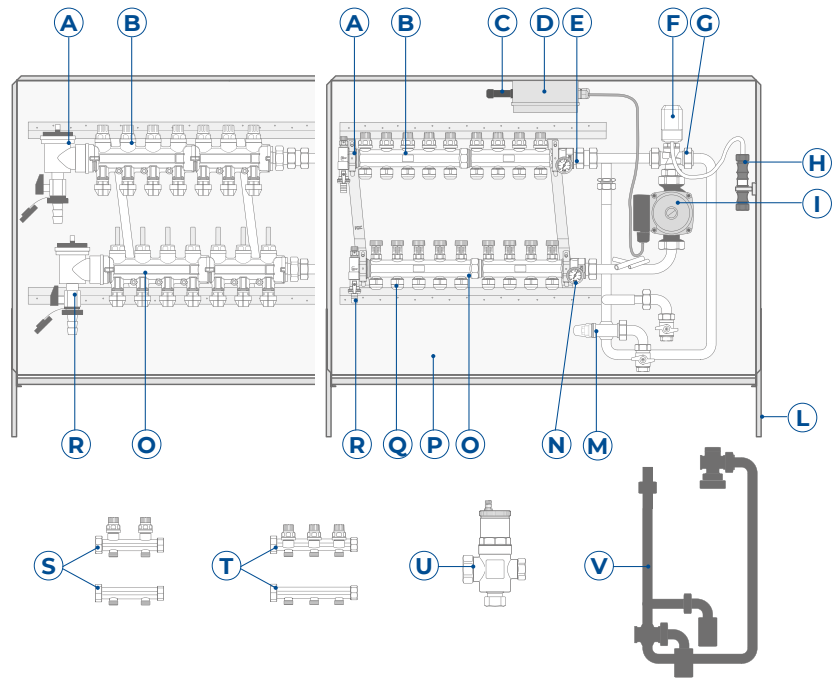

VJ 0-10 Kit with Top Composit manifold

n. outlets	dimensions l x h x p (cm)	code Ø 12	code Ø 16	code Ø 17
3+3	65x83÷89x14.5	3VP03N0QN2	3VP03N0QN6	3VP03N0QN7
4+4	65x83÷89x14.5	3VP04N0QN2	3VP04N0QN6	3VP04N0QN7
5+5	65x83÷89x14.5	3VP05N0QN2	3VP05N0QN6	3VP05N0QN7
6+6	80x83÷89x14.5	3VP06N0QN2	3VP06N0QN6	3VP06N0QN7
7+7	80x83÷89x14.5	3VP07N0QN2	3VP07N0QN6	3VP07N0QN7
8+8	80x83÷89x14.5	3VP08N0QN2	3VP08N0QN6	3VP08N0QN7
9+9	100x83÷89x14.5	3VP09N0QN2	3VP09N0QN6	3VP09N0QN7
10+10	100x83÷89x14.5	3VP10N0QN2	3VP10N0QN6	3VP10N0QN7
11+11	100x83÷89x14.5	3VP11N0QN2	3VP11N0QN6	3VP11N0QN7
12+12	100x83÷89x14.5	3VP12N0QN2	3VP12N0QN6	3VP12N0QN7

VJ 0-10 Kit with Control manifold

n. outlets	dimensions l x h x p (cm)	code Ø 12	code Ø 16	code Ø 17
3+3	65x83÷89x14.5	3VO03N0QN2	3VO03N0QN6	3VO03N0QN7
4+4	65x83÷89x14.5	3VO04N0QN2	3VO04N0QN6	3VO04N0QN7
5+5	65x83÷89x14.5	3VO05N0QN2	3VO05N0QN6	3VO05N0QN7
6+6	80x83÷89x14.5	3VO06N0QN2	3VO06N0QN6	3VO06N0QN7
7+7	80x83÷89x14.5	3VO07N0QN2	3VO07N0QN6	3VO07N0QN7
8+8	80x83÷89x14.5	3VO08N0QN2	3VO08N0QN6	3VO08N0QN7
9+9	100x83÷89x14.5	3VO09N0QN2	3VO09N0QN6	3VO09N0QN7
10+10	100x83÷89x14.5	3VO10N0QN2	3VO10N0QN6	3VO10N0QN7
11+11	100x83÷89x14.5	3VO11N0QN2	3VO11N0QN6	3VO11N0QN7
12+12	100x83÷89x14.5	3VO12N0QN2	3VO12N0QN6	3VO12N0QN7

FOR COMPLETE CODING REFER TO PAGE 223

Example of thermoregulation with VJ 0-10 kit

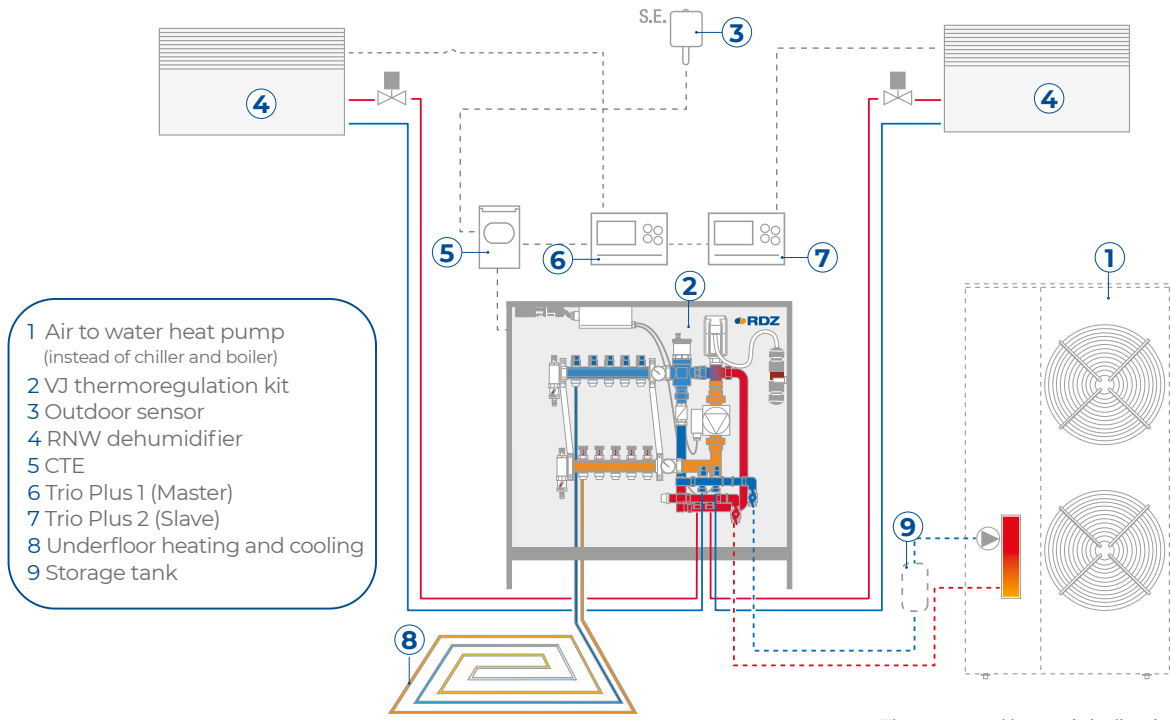

HYDRAULIC PERFORMANCES

(performance of electronic self-regulating circulator)

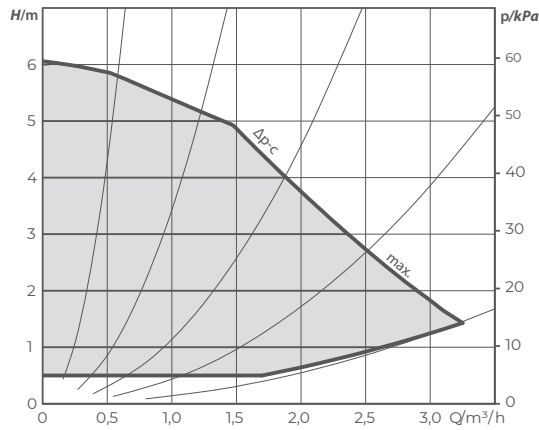

ACCESSORIES FOR KIT VJ



Anti-condensation Insulation

The anti-condensation insulation is used for each component which can be in contact with cool water in the low-temperature system. It is recommended for summer cooling systems.

MODEL	CODE
For Kit VJ	--

OPTIONALS FOR PF, EASY CLIMA AND VJ KITS



3-way Air Trap

This 3-way air separator (M 1 ¼" - F ¾" - M ¾") is made of brass, and it is used to eliminate the air in the radiant system.

SIZE	CODE
M 1" ¼ - F ¾" - M ¾"	--



HT Manifolds with 2 or 3 outlets

Pair of manifolds made of brass diam. ¾" MF, distance between outlets 45 mm, Eurocone ¾" for the connection of Pex, multilayer or copper pipes. Electrothermic heads can be applied on the manifolds. They are available with 2 or 3 outlets.

SIZE	CODE
2 outlets	--
3 outlets	--



Fittings for Multilayer Ø 16 - 20

Fittings for multilayer. They can be used with b!klimax, CONTROL and TOP COMPOSIT manifolds.

SIZE	CODE
Ø 16x2	1186116
Ø 20x2	1186120



Closing Plug for manifolds

Blind cap used to close circuits on manifolds.

MODEL	CODE
For Top Composit	1185010
For Control and high-temperature	1057000

CODING SYSTEM

With the following coding system it is possible to configure the desired thermoregulation kit through a few simple steps.

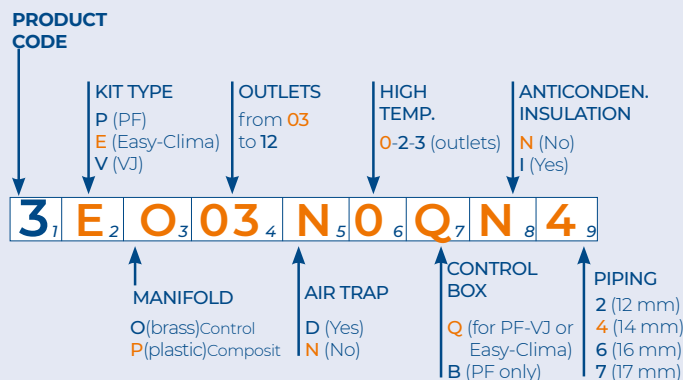

From left to right:

1) product code 2) type of kit: PF, Easy-Clima or VJ 3) type of manifold (brass or plastic) 4) number of manifold outlets 5) air trap included or not 6) number of high temperature outlets 7) control box type 8) anti-condensation insulation included or not 9) pipe diameter 12, 14, 16 or 17 mm.



**Underfloor radiant
systems
for industrial
applications**





The ideal climate even in large spaces

Underfloor heating systems are particularly suitable for installation in buildings such as industrial ones with high heights, as the diffusion of heat by radiation allows heating at eye level.

The uniformity of the temperatures, in addition to ensuring a pleasant sensation of physical well-being, allows the system to be maintained at a very low operating temperature, significantly reducing consumption compared to traditional systems. The low temperature of the thermovector fluid also allows the use of energy generators from renewable sources.

The absence of convective motions eliminates the movement of dust and impurities in the air, safeguarding the proper functioning of machinery and preserving the healthiness of the rooms; the integration in the floor facilitates cleaning and makes all the surfaces fully exploitable for work activities as they are clutter-free.

Lastly, the industrial radiant underfloor heating system has no contraindications in terms of fire prevention as it does not include flammable components or high-temperature parts.

INDUSTRIAL UNDERFLOOR RADIANT SYSTEMS ADVANTAGES:



***USE OF RENEWABLE
ENERGY SOURCES***



***THERMAL COMFORT
WITHOUT WASTE***



***ABSENCE OF MOVEMENT
OF AIR AND DUST***



***OPTIMISATION
OF SPACES***



***NO MAINTENANCE
COSTS***



Industrial shaped panel system is a low-temperature underfloor heating system characterised by pipes anchored to an insulated base and embedded in the screed.

It is an ideal solution to benefit from the installation advantages offered by a civil system even in the case of large industrial buildings.

The central element of the system is the industrial shaped panel with studs made of expanded polystyrene in compliance with UNI EN 13163, with dimensions 1170x837x20 mm, characterised by high mechanical resistance.

Equipped with joints on all four sides to facilitate panel coupling, it can be laid directly on rolled screed and stabilised after appropriate waterproofing.

The system is completed with high-density cross-linked PE-Xc Ø 20 mm RDZ Tech pipe, with anti-oxygen barrier according to DIN 4726, hook clips, support open elbows, manifold, industrial perimeter belt, sleeves to protect the expansion joints and light felt to be used as thermal insulation.

FEATURES

- Panel with high compressive strength
- RDZ Tech PE-Xc pipe Ø 20 mm
- Specific system for industrial buildings
- Good thermal insulation
- Fast installation



SECTION AND DIMENSIONS

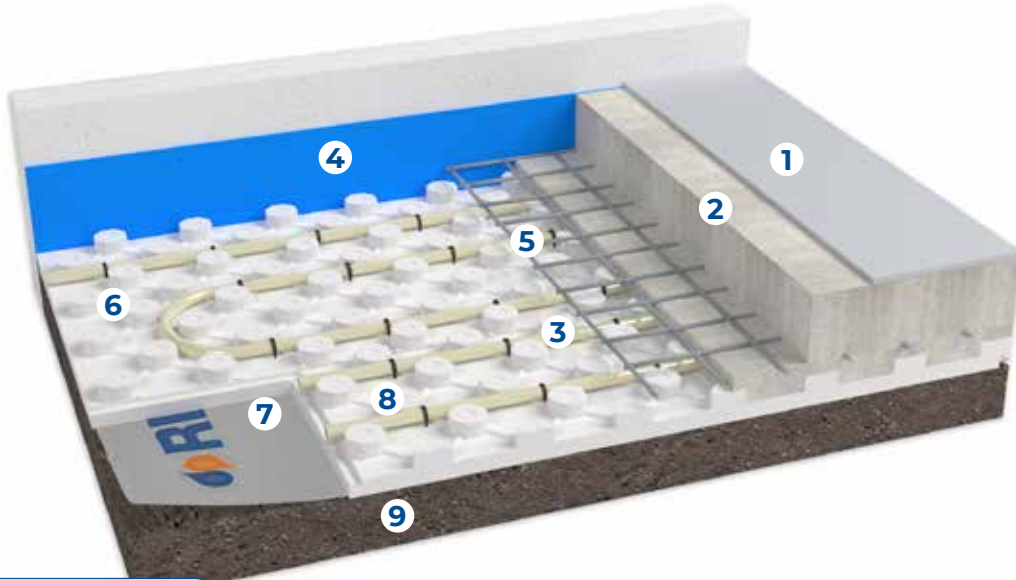

- 1 Quartz
- 2 Concrete
- 3 RDZ Tech pipe Ø 20-16
- 4 Insulation edge
- 5 Reinforced mesh
- 6 Industrial Shaped Panel
- 7 Nylon
- 8 Hooked clip
- 9 Fixed rolled screed

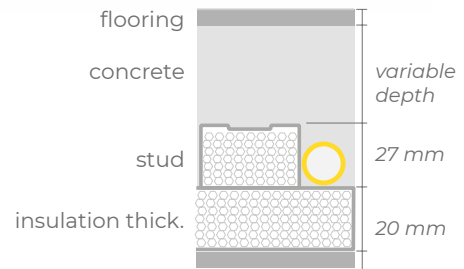

PRODUCTS THAT COMPOSE THE SYSTEM



Industrial shaped panel

It is a waterproof panel, made of moulded expanded polystyrene (according to UNI 13163), which has high mechanical resistance. These panels are provided with a tongue along the perimeter to connect them for proper alignment. They have a moulded surface with reliefs of 27 mm, so that the cross-linked polyethylene pipes (Ø 20 mm) can be fitted into the tabs of the panel at intervals of 8.3 cm or multiples.

SIZE	THICKNESS	CODE
1170x837 mm	20 mm	1040232

Panel features	Value	Unit	Standard
Size	1170x837x20	mm	UNI 822
Standard thickness	47	mm	UNI 823
Insulation base thickness	20	mm	
Thermal conductivity 10 °C	0.033	W/(m · K)	UNI EN 12667
Compressive stress at 10% deformation	200	kPa	UNI 826
Resistance to compression with 5% deformation	180	kPa	UNI 826
Resistance to compression with 2% deformation	130	kPa	UNI 826
Thermal resistance	0.80	(m ² · K)/W	UNI EN 13163
Equivalent total thickness	26.5	mm	UNI EN 1264-3
Water vapour diffusion resistance factor	40 to 100	1	UNI EN 12086
Limit of operating temperature	70	°C	
Fire reaction	F	Euroclass	EN ISO 11925-2
Declaration according to UNI EN 13163	EPS-EN13163-T1-L1-W1-S2-P4-BS250-CS(10)200-DS(70,-)1-WL(T)3-MU(40-100)		



RDZ Tech PE-Xc Pipe Ø 20 Interior Layer

RDZ Tech pipe Ø 20-16 mm made of high-density electrophysically cross-linked polyethylene with oxygen barrier. This pipe is produced according to DIN EN ISO 15875/2 and DIN 4726.

TYPE	ROLL	CODE
PE-Xc	240 m	1012240
PE-Xc	600 m	1012600



Industrial Perimeter Belt

Industrial edge insulation to absorb floor expansions and eliminate heat or acoustic channels in the walls. It is made of expanded polyethylene with 100% closed cell structure, and it has an adhesive strip on one side.

SIZE	CODE
10x300 mm	1071110



Humidity Barrier Sheet

The polyethylene sheet should be laid under the insulating panel, thus acting as a humidity barrier.

SIZE	PACKAGE	CODE
Th. 0.18 mm	custom-made	1901100



Open elbow

Open elbow Ø 20 made of plastic material. It is used to support the pipes near the manifolds vertically and to protect them from any damage.

SIZE	CODE
Ø 20 mm	1140020



Hooked clip

Hooked clips made of plastic material to ensure secure positioning of the pipe on the insulating panels.

PACKAGE	CODE
100 pieces	1017000

Tips for material calculation

Needed products	Requirements
Industrial Shaped Panel	Area to be covered +2%
Humidity Barrier Sheet	Area to be covered +20%
RDZ Tech PE-Xc pipe 20x2	Depending on the average pitch Total length = area/pitch [m/m]
Industrial Perimeter Belt h 300 mm	Calculate the perimeter of the building
Hooked clip	5 for each circuit
Open elbow Ø 20	2 for each circuit

Optional products	Requirements
Sleeve for expansion joints Ø28 mm	2 for each crossing of a joint

Manifolds, heads, accessories and optional products (from page 238).

Note: The requirements in the table are indicative. Please refer to the construction project for confirmation.

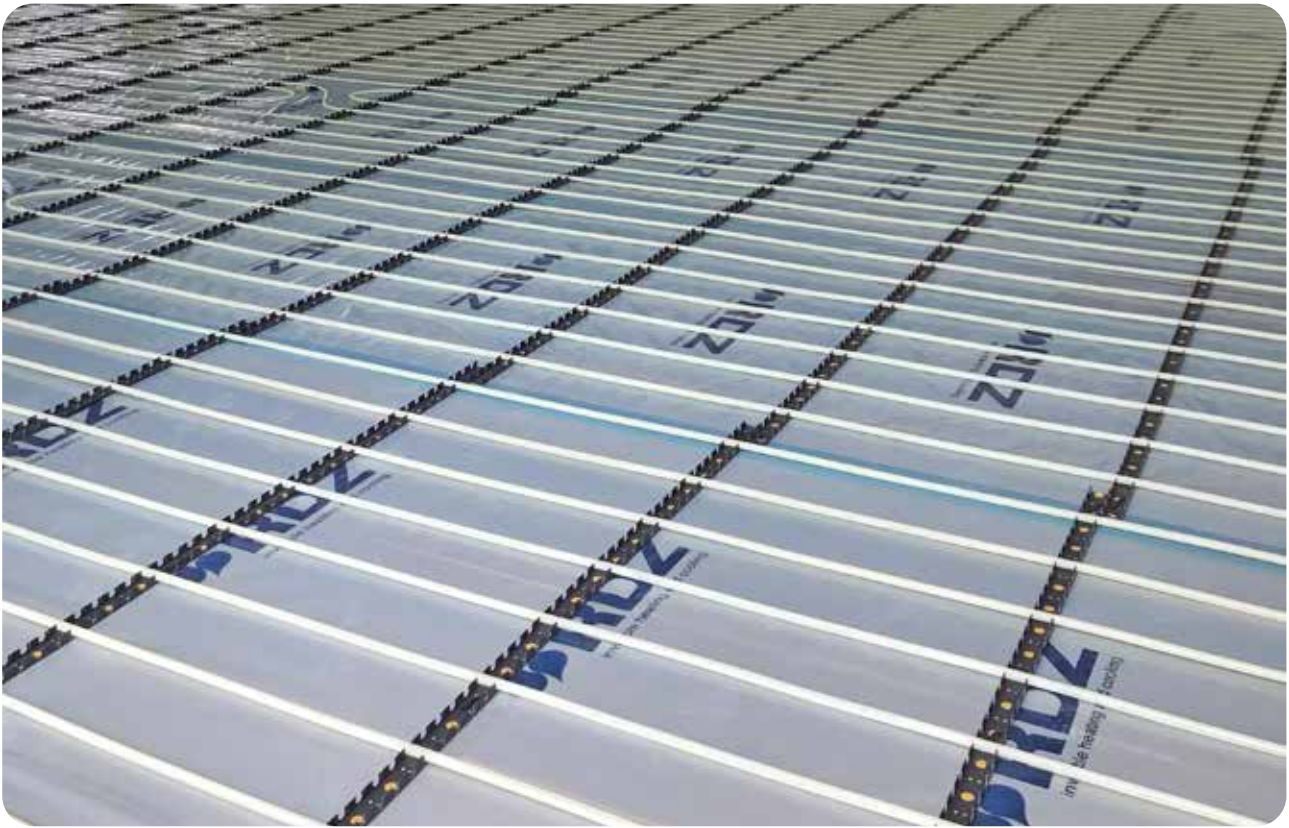

PVC bar system is a solution for underfloor heating in industrial buildings characterised by pipes housed in a support bar anchored to an insulating panel base.

The central element of the system is the PVC bar with U-shaped profile in which the PE-Xc \varnothing 20 or PE-Xa 25 mm pipe is placed. Thanks to the lower adhesive backside and special plastic fixing clips, the bar is anchored to the insulation layer made of XL smooth panel made of extruded expanded polystyrene produced with ecological CFC, HCFC and HFC-free gases, characterised by high compressive strength and available in different thicknesses (from 20 to 80 mm).

The system is completed with the humidity barrier sheet to protect the insulation, the open support elbows, the manifold, the industrial perimeter frame, the joint sleeve to protect the expansion joints and the light felt to be used as a thermal insulation.

FEATURES

- RDZ Tech PE-Xc pipe \varnothing 20 mm or PE-Xa pipe \varnothing 25 mm
- Specific system for industrial buildings
- Thermal insulation with high compressive strength panel
- Wide range of insulation thicknesses (20-30-40-50-60 or 80 mm)
- Easy installation



SECTION AND DIMENSIONS

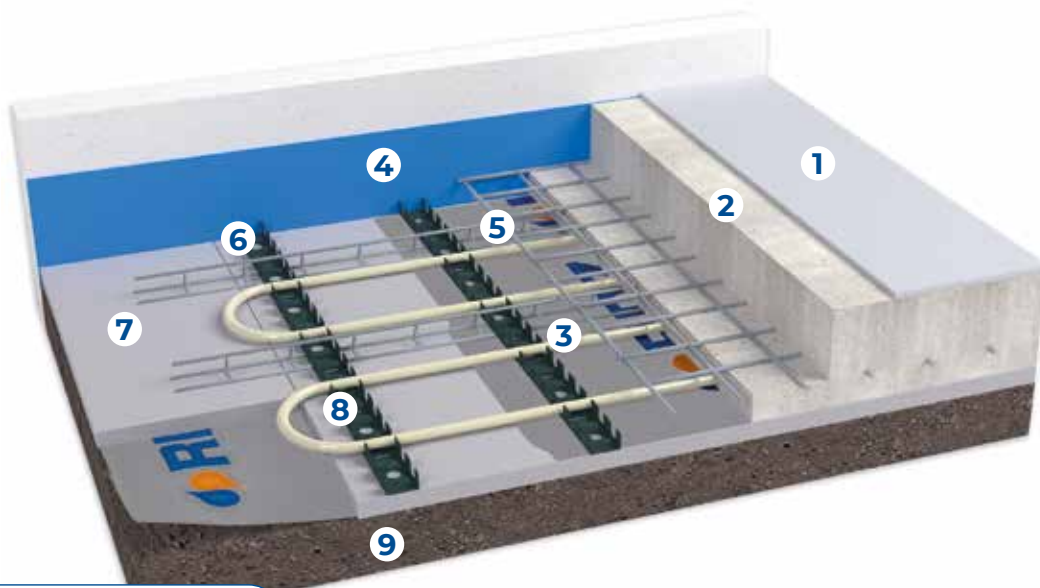

- 1 Quartz
- 2 Concrete
- 3 RDZ Tech pipe Ø 20 or 25
- 4 Industrial perimeter belt
- 5 Reinforced mesh
- 6 Supporting bar
- 7 Smooth extruded panel
- 8 Fixing Clip
- 9 Fixed rolled screed

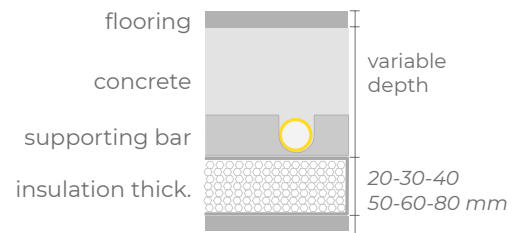

PRODUCTS THAT COMPOSE THE SYSTEM



Smooth extruded panel

Insulating panels made of extruded expanded polystyrene, produced with ecological gas, without CFC and HCFC, conforming to the European regulations EC 2037/2000. They have a closed-cell structure and react to fire according to Euroclass E. Compressive strength with 10% of deformation according to EN 826 between 250 and 300 kPa depending on the panel height.

Thermal resistance: 0.60 (m².K)/W 20 mm - 0.90 (m².K)/W 30 mm - 1.20 (m².K)/W 40 mm - 1.50 (m².K)/W 50 mm - 1.80 (m².K)/W 60 mm - 2.25 (m².K)/W 80 mm.

SIZE	THICKNESS	CODE
1250x600 mm	20 mm	1030231
1250x600 mm	30 mm	1130130
1250x600 mm	40 mm	1130140
1250x600 mm	50 mm	1130150
1250x600 mm	60 mm	1130160
1250x600 mm	80 mm	1130180

Panel features	Symbol	20	30	40	50	60	80	Unit
Declaration according to EN 13164								
Length		1250						mm
Width		600						mm
Thickness	dN	20	30	40	50	60	80	mm
Dimensional tolerances	T	1						
Thermal conductivity	λ_D	0.037	0.033	0.033	0.034		0.036	W / m·K
Thermal resistance	R_D	0.60	0.90	1.20	1.50	1.80	2.25	m ² ·K/W
Compressive strength	CS(10\Y)	≥ 300						kPa
Tensile strength perpendicular to the faces	TR	NPD						
Reaction to fire	Euroclass	E						
Continuous dripping		NPD						
Sound absorption index		NPD						
Long-term water absorption by total immersion	WL(T) 0.7	< 0.7						Vol. %
Long-term water absorption by diffusion	WD(V) 3	< 3						Vol %
Water vapour diffusion resistance factor	μ	NPD	150					
Creep - viscous creep under compression	CC (2/1.5/50)	130						kPa
Durability of reaction to fire due to: heat, weathering, ageing/degradation		The reaction to fire performance of XPS does not change over time						
Frost/thaw resistance after water absorption water absorption by diffusion	FTCD1	≤ 1						Vol %
Frost/thaw resistance after water absorption water absorption by total immersion	FTCI	NPD						
Dimensional stability in specific conditions of temperature and humidity	DS(70,90)	≤ 5						%
Deformation under specific load and temperature conditions	DLT(2)5	≤ 5						%
Unique product-type identification code: XPS -EN 13164-T1- DS(70,90)- DLT(2)5- CS(10\Y)300 (Thickness 20 mm) XPS -EN 13164-T1- DS(70,90)- DLT(2)5- CS(10\Y)300-CC(2/1,5/50)130- WD(V)3- WL(T)0,7- MU100- FTCD1 (Thickness from 30 to 60 mm)								



Supporting Bars for Pipes Ø 20 and Ø 25

Supporting bar made of PVC for RDZ Industrial System, which is used to fix piping Ø 20 or 25 mm. The bar has an adhesive strip on the backside, so that it can be fixed on the polyethylene foil with or without the insulating panel. Size for supporting bar Ø 20 mm: 4000x25x50 mm. Pipe spacing: 50 mm. Size for supporting bar Ø 25 mm: 4000x35x50 mm. Pipe spacing: 100 mm.

SIZE	CODE
Ø 20 mm - 4000x25x50 mm	1062120
Ø 25 mm - 4000x35x50 mm	1062125



RDZ Tech PE-Xc Pipe Ø 20 Interior Layer

RDZ Tech pipe Ø 20-16 mm made of high-density electrophysically cross-linked polyethylene with oxygen barrier. This pipe is produced according to DIN EN ISO 15875/2 and DIN 4726.

TYPE	ROLL	CODE
PE-Xc	240 m	1012240
PE-Xc	600 m	1012600



RDZ Tech PE-Xa Pipe Ø 25 Interior Layer

RDZ Tech PE-Xa pipe Ø 25-20.4 made of high-density polyethylene with type-a cross-linking. This pipe is produced according to DIN 16892 and DIN 4726.

TYPE	ROLL	CODE
PE-Xa	200 m	1013920
PE-Xa	600 m	1013900



Industrial Perimeter Belt

Industrial edge insulation to absorb floor expansions and eliminate heat or acoustic channels in the walls. It is made of expanded polyethylene with 100% closed cell structure, and it has an adhesive strip on one side.

SIZE	CODE
10x300 mm	1071110



Fixing clip

The fixing clips are made of plastic material and they are used to secure the reinforcement mesh.

PACKAGE	CODE
500 pieces	1111000



Humidity Barrier Sheet

The polyethylene sheet should be laid under the insulating panel, thus acting as a humidity barrier.

SIZE	PACKAGE	CODE
Th. 0.18 mm	custom-made	1901100



Open elbow

Open elbow made of plastic material. It is used to support the pipes near the manifolds vertically and to protect them from any damage.

SIZE	CODE
Ø 20 mm	1140020
Ø 25 mm	1140025

Tips for material calculation

Needed products	Requirements
Smooth extruded panel	Area to be covered +2%
Humidity Barrier Sheet	Area to be covered +20%
RDZ Tech pipe PE-Xc Ø 20x2 or PE-Xa Ø 25x2	As a function of average pitch Total length = area/pitch [m/m]
Industrial perimeter belt h300 mm	Calculate the perimeter of the building
PVC support bar	0.9 m every m ²
Clips for fixing PVC bar to insulation	1 clip for each metre of bar
Open elbow Ø 20 or Ø 25	2 for each circuit
Optional products	Requirements
Sleeving for expansion joints	2 for each crossing of a joint
Hose clamps	6 clamps for each circuit

Manifolds, heads, accessories and optional products (from page 238).

Note: The requirements in the table are indicative. Please refer to the construction project for confirmation.



Industrial mesh system is a solution for underfloor heating in industrial buildings characterised by piping anchored to the mesh by special clips and embedded in the screed.

The system is ideal for winter air-conditioning of large warehouses and can be laid directly on rolled and stabilised gravel after suitable waterproofing.

The central element of the system is the RDZ Tech PE-Xc pipe \varnothing 20 mm anchored to the electro-welded net \varnothing 6 (not supplied by RDZ) by special industrial clips made of plastic material. For heating large surfaces, PE-Xa pipe \varnothing 25 can be used combined with 2" diameter stainless steel manifolds. The system can be optionally combined with the smooth extruded panel made of extruded polystyrene foam, characterised by high compressive strength and available in different insulation thicknesses (from 20 to 80 mm).

The solution is completed with the moisture barrier sheet to protect the insulation, the support curves, the manifold, the industrial perimeter frame, the sheathing to protect the expansion joints and the needle felt to be used as a thermal break.

FEATURES

- Panel with high compressive strength
- RDZ Tech pipe in PE-Xc \varnothing 20 or PE-Xa \varnothing 25
- Specific system for industrial buildings
- Possibility of thermal insulation with 20, 30, 40, 50, 60 or 80 mm extruded smooth panel
- Easy installation



SECTION OF THE SYSTEM

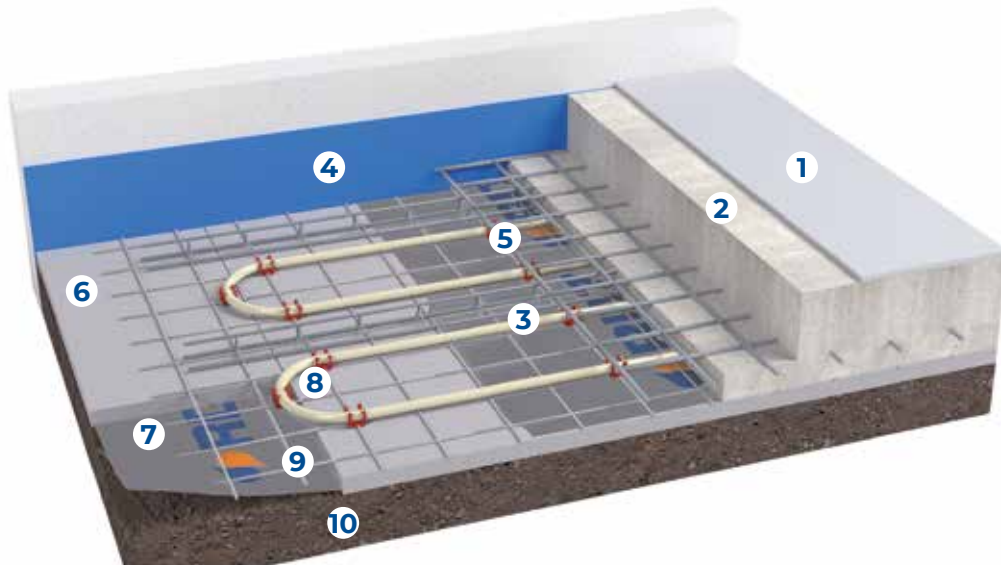

- 1 Quartz
- 2 Concrete
- 3 RDZ Tech pipe Ø 20 or Ø 25
- 4 Industrial perimeter belt
- 5 Reinforced mesh
- 6 Smooth extruded panel
- 7 Nylon
- 8 Clip Industry
- 9 Anti-shrinkage mesh Ø 6
- 10 Fixed rolled screed

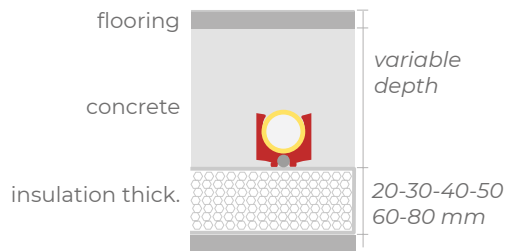

PRODUCTS THAT COMPOSE THE SYSTEM



Smooth extruded panel

Insulating panels made of extruded expanded polystyrene, produced with ecological gas, without CFC and HCFC, conforming to the European regulations EC 2037/2000. They have a closed-cell structure and react to fire according to Euroclass E. Compressive strength with 10% of deformation according to EN 826 between 250 and 300 kPa depending on the panel height.

SIZE	THICKNESS	CODE
1250x600 mm	20 mm	1030231
1250x600 mm	30 mm	1130130
1250x600 mm	40 mm	1130140
1250x600 mm	50 mm	1130150
1250x600 mm	60 mm	1130160
1250x600 mm	80 mm	1130180

Panel features	Symbol	20	30	40	50	60	80	Unit
Declaration according to EN 13164								
Length		1250						mm
Width		600						mm
Thickness	dN	20	30	40	50	60	80	mm
Dimensional tolerances	T	1						
Thermal conductivity	λ_D	0.037	0.033	0.033	0.034		0.036	W / m·K
Thermal resistance	R_D	0.60	0.90	1.20	1.50	1.80	2.25	m ² ·K/W
Compressive strength	CS(10\Y)	≥ 300						kPa
Tensile strength perpendicular to the faces	TR	NPD						
Reaction to fire	Euroclass	E						
Continuous dripping		NPD						
Sound absorption index		NPD						
Long-term water absorption by total immersion	WL(T) 0.7	< 0.7						Vol. %
Long-term water absorption by diffusion	WD(V) 3	< 3						Vol %
Water vapour diffusion resistance factor	μ	NPD	150					
Creep - viscous creep under compression	CC (2/1.5/50)	130						kPa
Durability of reaction to fire due to: heat, weathering, ageing/degradation	The reaction to fire performance of XPS does not change over time							
Frost/thaw resistance after water absorption water absorption by diffusion	FTCD1	≤ 1						Vol %
Frost/thaw resistance after water absorption water absorption by total immersion	FTCI	NPD						
Dimensional stability in specific conditions of temperature and humidity	DS(70,90)	≤ 5						%
Deformation under specific load and temperature conditions	DLT(2)5	≤ 5						%
Unique product-type identification code: XPS -EN 13164-T1- DS(70,90)- DLT(2)5- CS(10\Y)300 (Thickness 20 mm) XPS -EN 13164-T1- DS(70,90)- DLT(2)5- CS(10\Y)300-CC(2/1,5/50)130- WD(V)3- WL(T)0,7- MUI00- FTCD1 (Thickness from 30 to 60 mm)								



RDZ Tech PE-Xc Pipe Ø 20 Interior Layer

RDZ Tech pipe Ø 20-16 mm made of high-density electrophysically cross-linked polyethylene with oxygen barrier. This pipe is produced according to DIN EN ISO 15875/2 and DIN 4726.

TYPE	ROLL	CODE
PE-Xc	240 m	1012240
PE-Xc	600 m	1012600



RDZ Tech PE-Xa Pipe Ø 25 Interior Layer

RDZ Tech PE-Xa pipe Ø 25-20.4 made of high-density polyethylene with type-a cross-linking. This pipe is produced according to DIN 16892 and DIN 4726.

TYPE	ROLL	CODE
PE-Xa	200 m	1013920
PE-Xa	600 m	1013900



Industrial Perimeter Belt

Industrial edge insulation to absorb floor expansions and eliminate heat or acoustic channels in the walls. It is made of expanded polyethylene with 100% closed cell structure, and it has an adhesive strip on one side.

SIZE	CODE
10x300 mm	1071110



Red clips for 6-mm wire mesh and 20-mm pipe

Fixing clips for piping Ø 20 mm, made of plastic material. They are used to hold the pipe on the electro-welded mesh Ø 6 mm. The distance between rods represents the pipe spacing. Easy installation thanks to clip fixer.

SIZE	CODE
Ø 20x6 mm	1140640



Industrial Clips 25/6

Fixing clips for pipes Ø 25 mm made of plastic to support the pipe with the welded mesh Ø 6 mm. The single meshes should correspond to the spacing between the pipes.

SIZE	CODE
Ø 25x6 mm	1140625



Open elbow

Open elbow made of plastic material. It is used to support the pipes near the manifolds vertically and to protect them from any damage.

SIZE	CODE
Ø 20 mm	1140020
Ø 25 mm	1140025



Humidity Barrier Sheet

The polyethylene sheet should be laid under the insulating panel, thus acting as a humidity barrier.

SIZE	PACKAGE	CODE
Th. 0.18 mm	custom-made	1901100

Tips for material calculation

Needed products	Requirements
Smooth extruded panel	Area to be covered +2%
Humidity Barrier Sheet	Area to be covered +20%
RDZ Tech pipe PE-Xc Ø 20x2 or PE-Xa Ø 25x2	As a function of average pitch. Total length = area/pitch [m/m]
Industrial perimeter belt h 300 mm	Calculate the perimeter of the building
Clips for mesh Ø 6 mm, pipe Ø 20 o 25 mm	1.5 per metre of pipe
Open elbow Ø 20 or 25	2 for each circuit
Optional products	Requirements
Sleeving for expansion joints	2 for each crossing of a joint
Hose clamps	6 clamps for each circuit

Manifolds, heads, accessories and optional products (from page 238).

Note: The requirements in the table are indicative. Please refer to the construction project for confirmation.

**Underfloor radiant
systems
for industrial
applications**

Complements

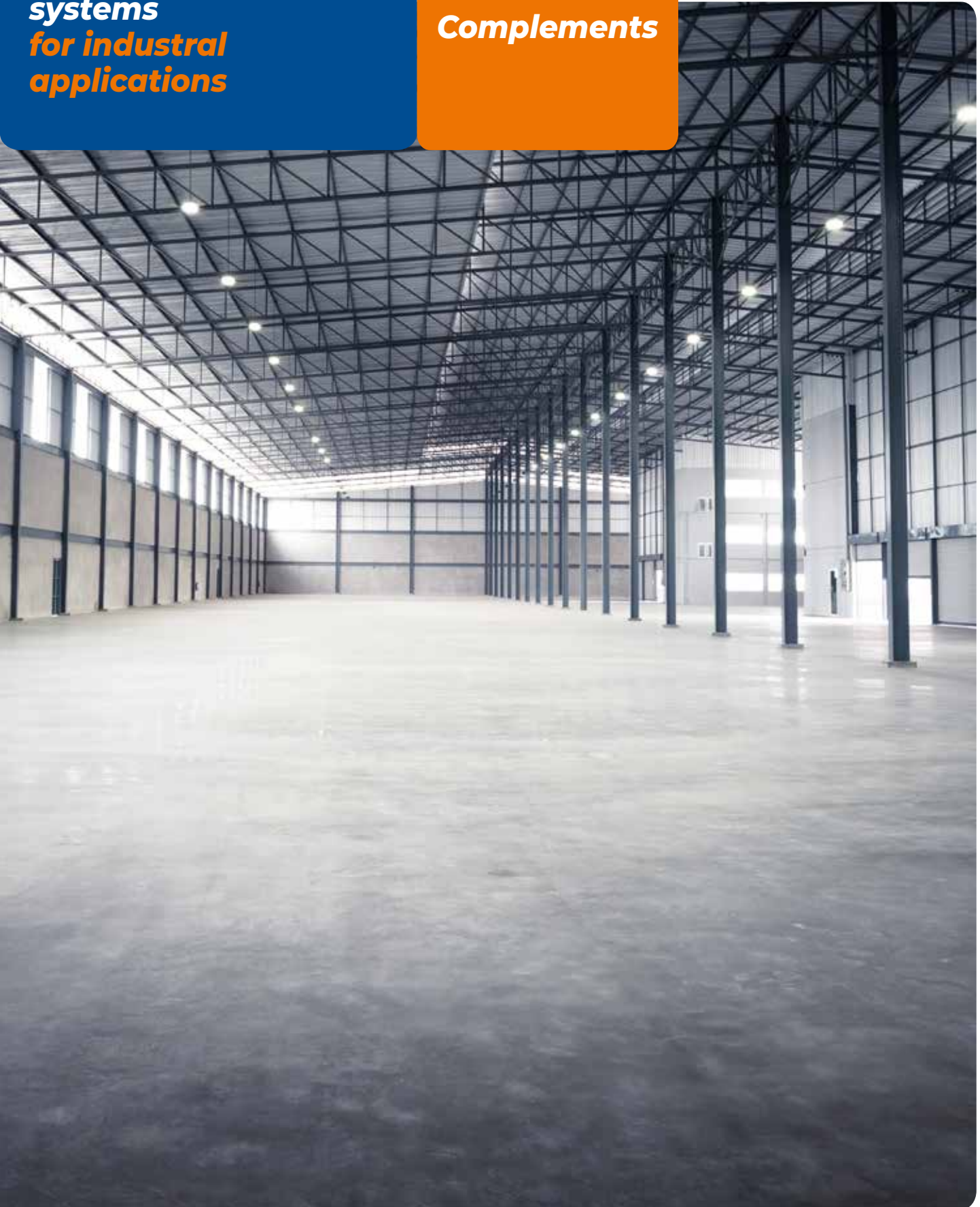

Control Pre-assembled Manifold

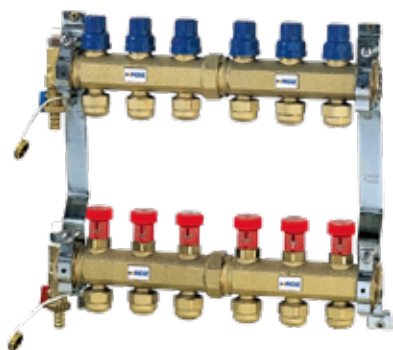

CONTROL manifolds Ø 1" 1/4 are made of brass, and they are used to distribute the pipes into the rooms. They are provided with on-off valves (suitable for electrothermic heads), micrometric lockshields with data labels to locate rooms, ball air vent valves and ball drain valves with hose nozzles and plugs, brackets with vibration-damping rubber tops, which can be installed in cabinets or on the wall, and fittings for pipes Ø 14 or Ø 17 mm.

Performance / size	Value	Unit
Liquid	water, glycolic water 30% at most	
Max. Operating Pressure	6	bar
Max. Testing Pressure	10	bar
Operating Temperature	5÷100	°C
Main outlets of the manifold	1" 1/4 F distance between axis 210	mm
Derivations	pipe clamp fitting 3/4" 14 - 17 - 20 distance between axis 50	Ø mm

outlets	code Ø 20
3+3	1153903
4+4	1153904
5+5	1153905
6+6	1153906
7+7	1153907
8+8	1153908
9+9	1153909
10+10	1153910
11+11	1153911
12+12	1153912
13+13	1153913

Dimension of the manifold												
Number of outlet		3+3	4+4	5+5	6+6	7+7	8+8	9+9	10+10	11+11	12+12	13+13
Only control manifold	cm	24,5	29,5	35,5	41	46	51	56	61	67,5	72,5	77,5
Control + Initial Fittings	cm	28	33	39	44,5	49,5	54,5	59,5	64,5	71	76	81
Control + Ball Valves	cm	34,5	39,5	45,5	51	56	61	66	71	77,5	82,5	87,5
Control + Zone Valve	cm	38	43	49	54,5	59,5	64,5	69,5	74,5	81	86	91
Control + Initial Fittings + Ball Valves	cm	38	43	49	54,5	59,5	64,5	69,5	74,5	81	86	91
Control + Initial Fittings + Zone Valve	cm	41,5	46,5	52,5	58	63	68	73	78	84,5	89,5	94,5
Control + Ball Valves + Zone Valve	cm	42,5	47,5	53,5	59	64	69	74	79	85,5	90,5	95,5
Control with all accessories	cm	47	52	58	63,5	68,5	73,5	78,5	83,5	90	95	>100

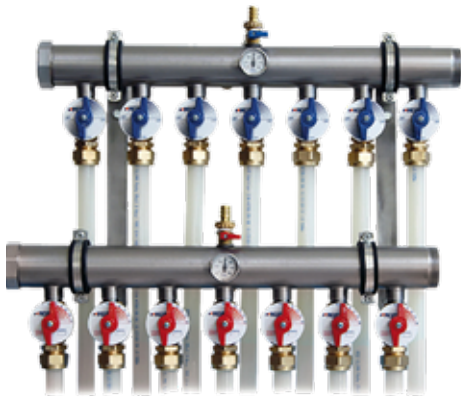

Industry Manifold

Industry manifold made of stainless steel $\varnothing 2''$, used to distribute pipes $\varnothing 25$ mm in warehouses. It includes shut-off ball valves and registers, an air and load cock, inflow and return thermometers (0-60 °C), fittings for pipes $\varnothing 25$ mm.

outlets	code $\varnothing 20$	code $\varnothing 25$	outlets	code $\varnothing 20$	code $\varnothing 25$
5+5	1145205	1145005	11+11	1145211	1145011
6+6	1145206	1145006	12+12	1145212	1145012
7+7	1145207	1145007	13+13	1145213	1145013
8+8	1145208	1145008	14+14	1145214	1145014
9+9	1145209	1145009	15+15	1145215	1145015
10+10	1145210	1145010			

outlets manifolds	A	B	C	cabinet code
5+5	320	440	780	1158075
6+6	400	520	780	1158075
7+7	480	600	780	1158075
8+8	560	680	1030	1158100
9+9	640	760	1030	1158100
10+10	720	840	1030	1158100
11+11	800	920	1200	1158120
12+12	880	1000	1200	1158120
13+13	960	1080	1400	1158140
14+14	1040	1160	1400	1158140
15+15	1120	1240	1400	1158140

Dimensional quotas

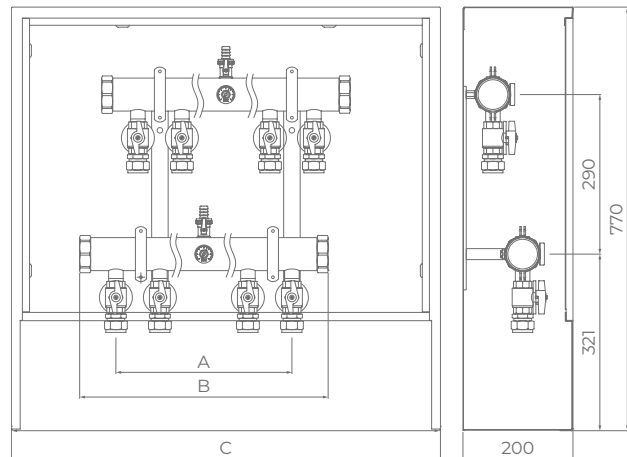

Wall cabinet

Cabinet for wall installation. It is made of powder-coated steel, thickness 20 cm, height 80 cm. It is open on the back, and it has dead holes for side entrances and a white metal powder-coated door and lockset. It is placed once the installation has been completed.



Suitable for all industrial systems

RDZ TECH PE-Xc Pipe Ø 20 Interior Layer

Pipe made of high-density electrophysically cross-linked polyethylene with oxygen barrier. This pipe is produced according to DIN EN ISO 15875/2 and DIN 16892 guaranteeing even and stable cross-links and constant characteristics over time

DIAMETER	ROLL	CODE
20 mm	240 m	1012240
20 mm	600 m	1012600

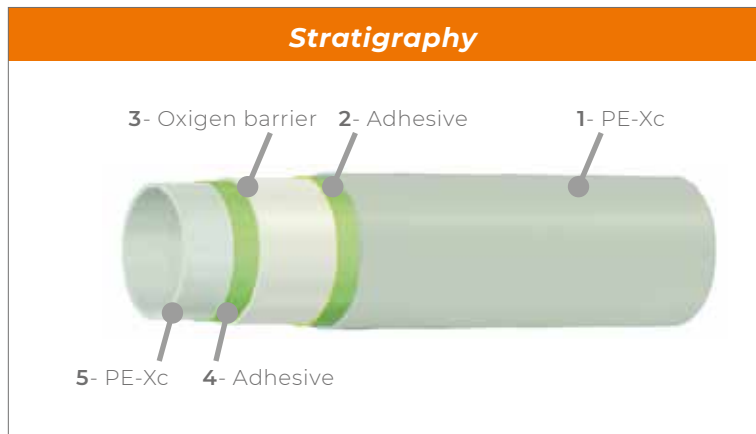

Application field	CLASS 4	For use with hot and cold water (T_{max} 70 °C)
	CLASS 5	For use with hot and cold water (T_{max} 90 °C)

Outside diam. (mm)	Thickness (mm)	Weight (g/m)	CLASS 4 (bar)	CLASS 5 (bar)	Water content (l/m)
20	2	120	8	6	0.20

Pipe Feature	Value	Unit	Standard
Standard			DIN EN ISO 15875 / DIN 4726
Density	0.945	g/cm ³	ISO 1183
Degree of cross-linking	≥ 60	%	
Ultimate Tensile Stress at 20 °C	24-26	N / mm ²	UNI EN ISO 527-2 / EN 60811-1
Elongation at break a 20 °C	400 ÷ 600	%	DIN EN ISO 6259-1 / EN 60811-1
Thermal conductivity	0.41	W / (m · K)	DIN 52612
Oxygen tightness	≤ 0.32	mg O ₂ / (m ² · d)	DIN 4726
Thermal expansion coefficient at 20 °C	1.5 · 10 ⁻⁴	m / (m · K)	
Softening temperature	> 130	°C	
Maximum ovalization	1.2	mm	
Roughness factor	0.0015		

RDZ Tech PE-Xa Pipe Ø 25 Interior Layer

RDZ Tech PE-Xa pipe Ø 25-20.4 made of high-density polyethylene with type-a cross-linking. This pipe is produced according to DIN 16892 and DIN 4726.



Suitable for Pvc bar and Industrial mesh system

DIAMETER	ROLL	CODE
25 mm	200 m	1013920
25 mm	600 m	1013900

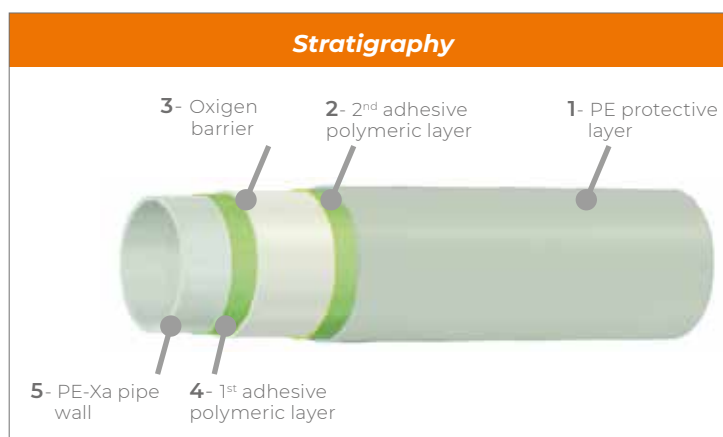

Application field	CLASS 4	For use with hot and cold water (T_{max} 70 °C)
	CLASS 5	For use with hot and cold water (T_{max} 90 °C)

Outside diam. (mm)	Thickness (mm)	Weight (g/m)	CLASS 4 (bar)	CLASS 5 (bar)	Water content (l/m)
25	2.3	174	8	6	0.326

Pipe Feature	Value	Unit	Standard
Standard			DIN 16892 / DIN 4726
Density	938	g/cm ³	DIN 53455
Degree of cross-linking	≥ 70	%	ISO 10147
Ultimate Tensile Stress at 20 °C	> 19	N / mm ²	DIN 53455
Elongation at break a 20 °C	> 400	%	ISO 6259
Thermal conductivity	0.40	W / (m · K)	DIN 52612
Oxygen tightness	≤ 0.32	mg O ₂ / (m ² · d)	DIN 4726
Thermal expansion coefficient at 20 °C	1.8 · 10 ⁻⁴	m / (m · K)	DIN 52328
Softening temperature	> 130	°C	DIN 53460
Maximum ovalization	1.2	mm	
Roughness factor	0.0005		

OTHER ACCESSORIES



Pipe Band

Pipe bands made of plastic and used to block pipes in industrial systems.

SIZE	CODE
20 cm	1130001



Joint Sleeve

Joint sleeve made of polypropylene, which is ideal to protect expansion joints.

SIZE	CODE
L. 300 - Ø 28 mm	1142028
L. 500 - Ø 40 mm	1142040



Light Felt

Light felt made of polypropylene flocks, thickness 5 mm, density 500 g/m². It is used for thermal insulation. Height: 2 m. Package: 50-m rolls.

SIZE	CODE
sp. 5 mm x h. 2 m	1901000

Our history



*For over 40 years
we have been
a worldwide reference company
in the field of heating and
cooling systems.
We work with passion
to ensure indoor comfort
thanks to innovative solutions,
specifically for residential,
commercial and
industrial buildings.
We design and produce
high-efficient and
high-performance systems
which offer energy saving,
comfort and health
throughout the year.
Invisible solutions
spreading a unique sensation
of wellbeing in any room.*

