

Variable Orifice Balancing Valve

142 Series

© Copyright 2018 Caleffi

Function

Caleffi 142 series low lead manual balancing valves are used to measure and adjust the fluid flow rate in hydronic or plumbing circuits. Characterized flow plug which provides precise system balancing valves and highly accurate flow compared to other setters with ball valve control. Turning the knob moves a plug within the fluid stream which varies the flow rate. The flow rate is determined according to the pressure drop value measured by a differential pressure meter connected to the pressure test ports, included. The flow rate is directly determined from the pressure differential created across the two test ports as fluid passes the adjustment plug. The valve design is variable orifice with pressure ports located upstream and downstream of the adjustment plug. Compared to fixed orifice designs where both test ports are located upstream of the adjustment plug, for a given size and flow rate, the variable orifice design produces a greater differential pressure value. In very low flow rate applications and with good fluid quality, this larger differential pressure signal can result in more accurate balancing. A memory stop feature allows the valve to be closed, and later reopened to the original set position. Insulation shells are available, purchase separately.

Product Range 142



	Cv	Insulation code:
142241A 1/2" NPT Female	3.4	CBN142241A
142251A 3/4" NPT Female	5.0	CBN142251A
142261A 1" NPT Female	7.5	CBN142261A
142271A 1 1/4" NPT Female	12.9	CBN142271A
142281A 1 1/2" NPT Female	16.8	CBN142281A
142291A 2" NPT Female	22.0	

Technical Specifications

Material:	Body:	DZR low-lead brass
	Bonnet:	DZR low-lead brass
	Control stem:	DZR low-lead brass
	Hydraulic seals:	peroxide-cured EPDM
	Knob:	PA6G30
	Pressure test ports:	DZR low-lead brass body, EPDM seal elements
		NSF/ANSI 372-2011, Drinking Water System Components-Lead Content
		Reduction of Lead in Drinking Water Act, California Health and Safety Code
		116875 S.3874, Reduction in Drinking Water Act, certified by ICC-ES, file
		PMG-1360.



Performance

Suitable fluids:	Water and glycol solutions
Max. percentage of glycol:	50%
Maximum working pressure:	232 psi (16 bar)
Working temperature range:	14–250°F (-10–120°C)
Accuracy:	±15%
Number of adjustment turns:	4
Number of regulating positions:	8

Connections:	Main:	1/2"–2" NPT female
	Valve body pressure test ports:	1/4" NPT female

Technical specifications of insulation

Material:	EPP
Thickness:	1/2 inch (15 mm)
Density:	2.8 lb/ft ³ (45 kg/m ³)
Thermal conductivity (ISO 2581):	- at 50°F (10°C): 0.257 BTU-in/hr-ft ² -°F (0.037 W/(m·K))
Working temperature range:	23 - 250°F (-5 - 120°C)
Reaction to fire (UL 94):	Class HBF



SAFETY INSTRUCTION

This safety alert symbol will be used in this manual to draw attention to safety related instructions. When used, the safety alert symbol means **ATTENTION! BECOME ALERT! YOUR SAFETY IS INVOLVED! FAILURE TO FOLLOW THESE INSTRUCTIONS MAY RESULT IN A SAFETY HAZARD.**



WARNING: This product can expose you to chemicals including lead, which is known to the State of California to cause cancer and birth defects or other reproductive harm. For more information go to www.P65Warnings.ca.gov.



CAUTION: All work must be performed by qualified personnel trained in the proper application, installation, and maintenance of systems in accordance with all applicable codes and ordinances.



CAUTION: Over-tightening and breakage can occur with the use of Teflon® pipe joint compounds. Teflon® provides lubricity so that care must be exercised not to over-tighten joints. Failure to follow these instructions could result in property damage and /or personal injury.



WARNING: System fluids are under pressure or temperature can be hazardous. Be sure the pressure has been reduced to zero and the system temperature is below 100°F (38°C). Failure to follow these instructions could result in property damage and/or personal injury.



CAUTION: If the series 142 balancing valve is not installed, commissioned and maintained properly, according to the instructions contained in this manual, it may not operate correctly and may endanger the user.



CAUTION: Make sure that all the connecting pipework is water tight.

Caleffi shall not be liable for damages resulting from stress corrosion, misapplication or misuse of its products.



CONSIGNE DE SÉCURITÉ

Ce symbole d'avertissement servira dans ce manuel à attirer l'attention sur la sécurité concernant instructions. Lorsqu'il est utilisé, ce symbole signifie.

ATTENTION! DEVEZ ALERTE ! VOTRE SÉCURITÉ EST EN JEU ! NE PAS SUIVRE CES INSTRUCTIONS PEUT PROVOQUER UN RISQUE DE SECURITE.



AVERTISSEMENT: Ce produit peut vous exposer à des produits chimiques comme le plomb, qui est connu dans l'État de Californie pour causer le cancer, dommages à la naissance ou autre. Pour plus d'informations rendez-vous www.P65Warnings.ca.gov.



ATTENTION: Tous les travaux doivent être effectués par du personnel qualifié formé à la bonne application, installation et maintenance des systèmes conformément aux codes et règlements locaux.



ATTENTION: Un serrage excessif et la rupture peut se produire avec l'utilisation de composés à joint de tuyau en Téflon®. Pouvoir lubrifiant Teflon® permet de sorte qu'il faut prendre soin de ne pas trop serrer les articulations. Le non-respect de ces instructions peut entraîner des dommages matériels et/ou des blessures.



AVERTISSEMENT: Les liquides du système sont sous pression ou de la température peuvent être dangereux. Être sûr que la pression a été réduite à zéro et la température du système est inférieure à 100°F (38°C). Le non-respect de ces instructions peut entraîner des dommages matériels et/ou des blessures.



ATTENTION: Si la vanne d'équilibrage, Série 142, n'est pas installé, mis en service et entretenu correctement, selon les instructions contenues dans ce manuel, il peut ne pas fonctionner correctement et peut mettre en danger l'utilisateur.



ATTENTION: S'assurer que tous les raccordements sont étanches.

Caleffi ne pourra être tenue responsable des dommages résultant de la corrosion, d'une mauvaise utilisation ou une mauvaise utilisation des produits.

Installation

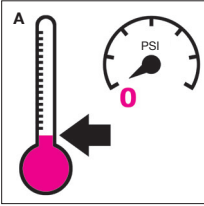

Assembly and disassembly of the valves should always be conducted while the system is cold and not pressurized (fig. A).

Install according to the flow direction indicated by the arrow on the valve body (fig. B).

Can be installed in any orientation (fig. C).

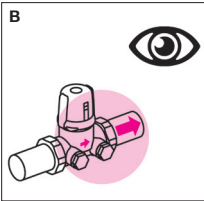

In order to ensure measuring accuracy, the balancing valve must be installed by keeping an upstream straight section of at least five diameters, increased to at least ten diameters if the nearest device upstream is a pump (fig. D).

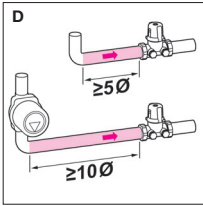
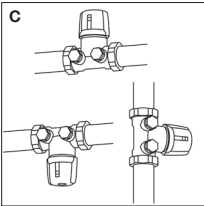

Scan to view .



142 Balancing Valve

Installation Tip

Dimensions

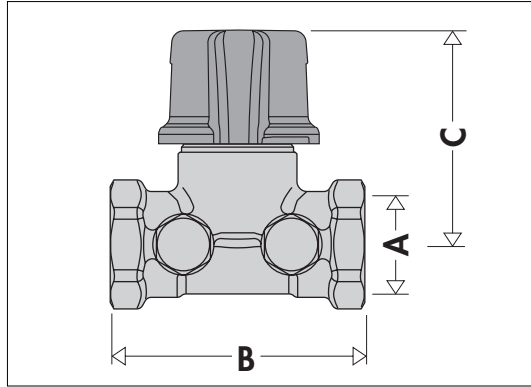

Code	A	B	C	Wt (lb)
142241A	1/2"	2 9/16"	2 1/2"	1.0
142251A	3/4"	2 15/16"	2 1/2"	1.2
142261A	1"	3 7/16"	2 1/2"	1.5
142271A	1 1/4"	3 3/4"	3 1/4"	2.3
142281A	1 1/2"	3 15/16"	3 3/8"	3.0
142291A	2"	4 3/4"	3 3/8"	3.5

Operating Principle

The 142 series balancing valve is a hydraulic device that controls the flow rate of a fluid. Turning the knob moves a plug within the fluid stream which varies the flow rate. The flow rate is determined according to the pressure drop value measured by a differential pressure meter connected to the pressure test ports. The opening position is indicated by the numbered indicator (fig. E):

- The turn indicator (1) shows a regulating scale scale from 0 to 4 (0 closure, 4 complete opening). Turning the knob manually through 360° causes the indicator to move by one unit.

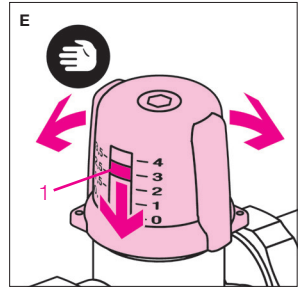

Use of the balancing valve: setting the flow rate (fig F-G)

NOTE: the indications + and – on the drawings refer to the pressure upstream and downstream of the component whose pressure differential is to be measured.

For the connection of the pressure test ports of the valve (2) with a differential pressure measuring device (3), use a pair of fittings with a measuring probe (fig. F).

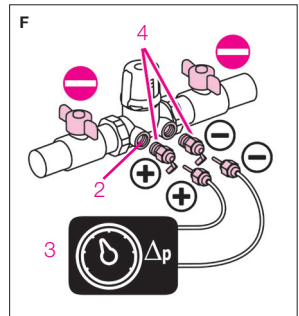

- As the thermal fluid passes, measure the Δp of the valve with any suitable differential pressure measuring device (fig. G);
- Using the “Hydraulic characteristics” sheet (sheet code 18203 supplied in the pack), find the flow rate value that is passing through the valve, consulting the diagram “ Δp -flow rates” corresponding to the size of the valve used.
- Turn the knob and repeat steps a) and b) until you reach the desired value.

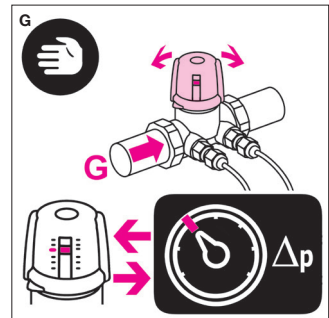

Correction for liquids of different densities

If using liquids with a density different from water at 70°F (20°C)

$\rho \approx 62.4 \text{ lb/ft}^3 (\approx 1 \text{ kg/dm}^3)$, correct the value of the measured head loss Δp using the following formula:

$$\Delta p^1 = \Delta p \cdot \frac{\rho}{\rho_{\text{water}}}$$

where:

Δp^1 = reference head loss in (psid(kPa))

Δp = measured head loss in (psid(kPa))

ρ = fluid density in lb/ft³ (kg/dm³)

Memory Stop on the 142 series balancing valve

Once you have balanced the flow rate, insert a 2.5 mm hexagonal key into the hole (5) in the balancing valve and fully turn it clockwise without forcing it. This sets the valve's maximum stroke position: if necessary, it is possible to shut off the balancing valve in the circuit by turning the knob fully clockwise manually. To restore the valve to its preset position, turn the adjustment knob fully counter-clockwise (fig. J).

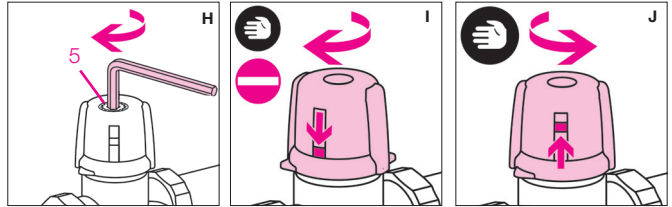

Locking/sealing the setting position (fig. K)

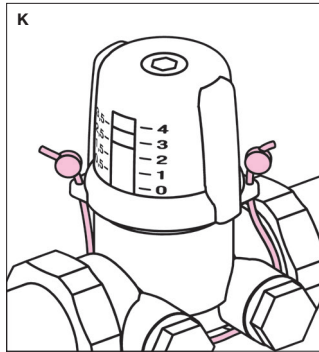

Installing Insulation

Join the size-specific insulation shells on the 142 series balancing valve, sold under separate code number.

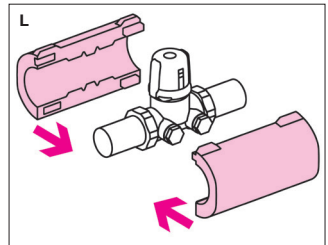



Hydronic Solutions

Caleffi North America, Inc.
3883 West Milwaukee Road
Milwaukee, WI 53208
T: 414.238.2360 F: 414.238.2366