

PLURIMOD EASY universal user module

Centralised Domestic Water

CONTECA metering



7002 series



Features

The PLURIMOD EASY user module performs heat regulation and consumption metering for heating/cooling and domestic hot and cold water.

PLURIMOD EASY is a hydraulically self-balanced solution, by means of a built-in differential pressure limiter valve and ideal for installation in variable flow rate systems.

Basic functions

- ON/OFF regulation with 2-way zone valve
- Heat metering in conformity with Directive 2004/22/EC (MID) fitted for centralised transmission
- All-over insulation incorporating shut-off valves
- Dynamic balancing by means of differential pressure limiter valve
- Flow rate limitation with pre-adjustment device

Optional functions

- Possibility for aggregation of 2 domestic water outlets.
- Centralised consumption data with 7550/750 series dataloggers.

The insulation supplied as standard guarantees low heat loss and adequate anti-condensation protection, thanks to the complete absence of thermal bridges.

Product range

- 700205** Recessed template box 480x480 mm for interior use RAL 9010. With flushing pipes and insulation
- 700205 002** Wall mounting template for PLURIMOD EASY. With flushing pipes and insulation
- 700205 003** Plate
- 700213** Hydraulic module with Δp limitation to 2 m w.g. ON/OFF actuator, electric supply 230 V (ac)
- 700214** Hydraulic module with Δp limitation to 2 m w.g. ON/OFF actuator, electric supply 24 V (ac)
- 700215** Hydraulic module with Δp limitation to 3 m w.g. ON/OFF actuator, electric supply 230 V (ac)
- 700216** Hydraulic module with Δp limitation to 3 m w.g. ON/OFF actuator, electric supply 24 V (ac)

Characteristic components

- Reversible installation type hydraulic module composed of:
- 2-way zone valve with ON/OFF control by means of thermo-electric actuator 6562 series
 - **Δp limiting valve** with setting of **2 or 3 m w.g.** (20 or 30 kPa)
 - pocket for immersion probe on flow side with stainless steel strainer cartridge
 - maximum flow rate pre-adjustment device.

CONTECA 7554 series heat meter (24 V (ac) electric supply) and centralised transmission on RS-485 bus.

Technical specifications

Materials

Components: brass EN 12165 CW614N
brass EN 12165 CW617N
brass EN 12165 CB753S

Performance

Max. working pressure: 10 bar
Primary side minimum Δp : 3,5 m w.g. (35 kPa) (code 700213/14)
5 m w.g. (50 kPa) (code 700215/16)
Primary side maximum Δp : 1,5 bar (150 kPa) (code 700213/14)
2 bar (200 kPa) (code 700215/16)
Working temperature range: 3–90°C
Medium: water, glycol solutions
Max. percentage of glycol: 30%
Connections: 3/4" M

Insulation

Material: Closed cell expanded EPP
Minimum thickness: approx. 10 mm
Average thickness: approx. 15 mm
Density: 50 kg/m³
Thermal conductivity: 0,037 W/(m·K) (at 10°C)
Reaction to fire (UL94): class HBF

PLURIMOD EASY hydraulic module code 700213 - 700214 - 700215 - 700216

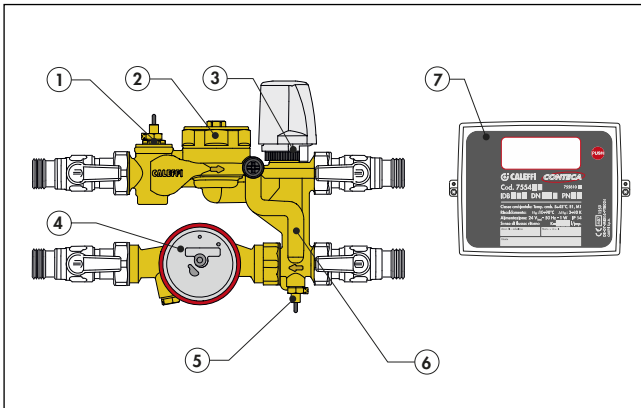

The module includes:

- 1 - flow probe pocket with strainer
- 2 - 2 or 3 m w.g. pressure differential limiter valve.
- 3 - zone valve with flow rate pre-adjustment and 6562 series thermo-electric actuator
- 4 - volume meter Ø 3/4"
- 5 - return probe pocket
- 6 - differential pressure control valve pressure test port hydraulic module structural reinforcement
- 7 - CONTECA electronic panel 7554 series

Code		Maximum downstream Δp
700213	module with 230 V (ac) actuator	2 m w.g. (20 kPa)
700214	module with 24 V (ac) actuator	2 m w.g. (20 kPa)
700215	module with 230 V (ac) actuator	3 m w.g. (30 kPa)
700216	module with 24 V (ac) actuator	3 m w.g. (30 kPa)

Specifications of 6562 series thermo-electric actuator

Voltage:	230 V (ac) / 24 V (ac) (blue and brown wire)
Auxiliary microswitch:	grey and black wire
Contact rating:	0,8 A (230 V)
Power consumption:	3 W
Ambient temperature range:	0-55°C
Protection class:	IP 54
Operating time:	from 120 to 180 s

Note: For more information on the actuator consult [tech. broch. 01198](#)

6562 series actuator connection diagram

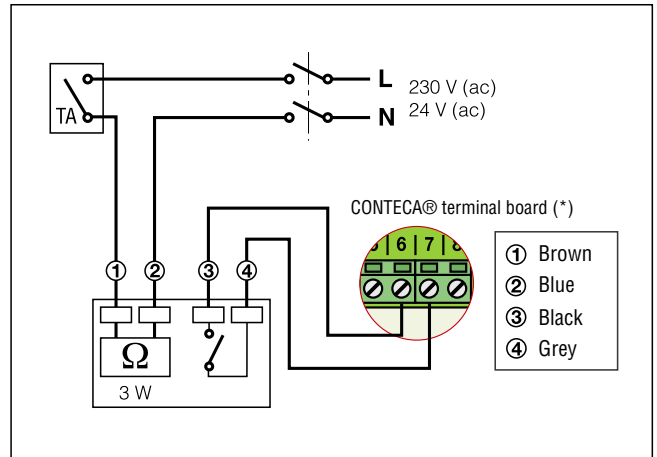

(*) Optional connection for metering zone valve open hours and for heating service remote control ("Domotics").

Maintenance

Inspecting the strainer

Unscrew cap (A) to gain easy access to the strainer for periodic inspections and maintenance. The strainer is only present on the flow pipe.

Air vent

PLURIMOD EASY is equipped with two air vents for complete removal of air from the system.

The two caps (D2) on the differential pressure control valve pressure port passage make it possible to vent any air in the return pipe, while venting of air from the flow section is possible by means of the screw (D1).

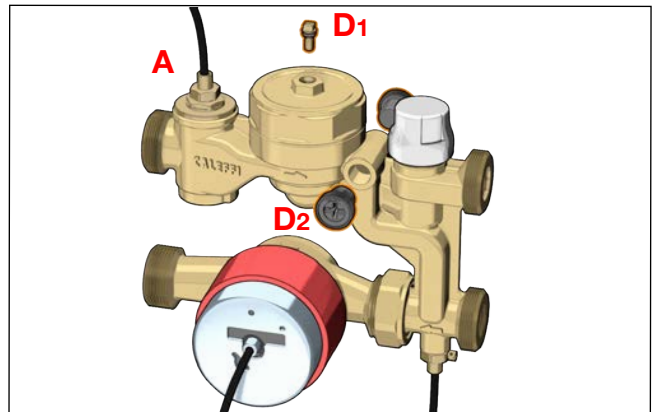

Hydraulic-functional diagram

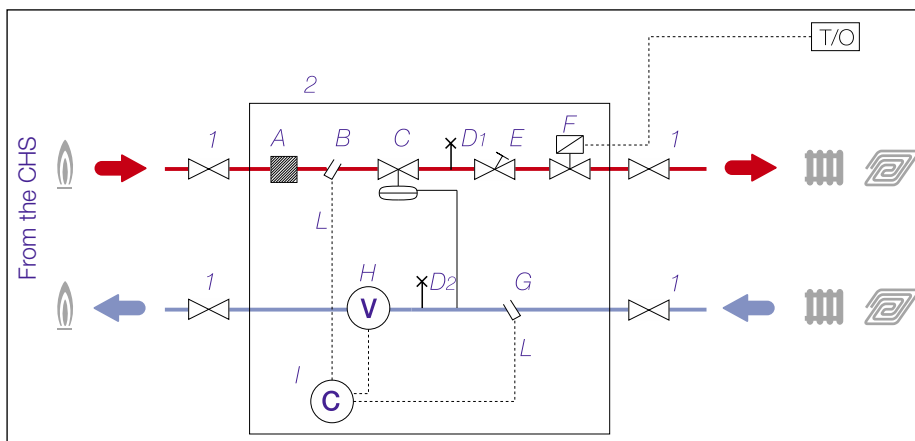

1 - Shut-off valves (supplied with box/template code 700205/700205 002)

2 - PLURIMOD EASY module composed of:

- A - Strainer
- B - Flow probe pocket
- C - Differential pressure regulator
- D - Air vents
- E - Flow rate pre-adjustment device
- F - Thermo-electric zone valve
- G - Return probe pocket
- H - Ø 3/4" volume meter
- I - CONTECA electronic panel
- L - Temperature probes

T/C: Chrono-thermostat/Clock (not of our supply)

Differential pressure limiter

The built-in Δp limiter in PLURIMOD EASY is a **dynamic balancing device** that regulates the pressure difference between two points of the hydraulic user circuit.

With a pressure differential (inlet Δp) greater than the setting of the limiter device (Δp_{set}), the device cuts in and creates a pressure drop such as to produce a downstream Δp (intermediate Δp) identical to the setting value.

This action is dynamic: the differential pressure limiter control device operates continuously **so that the pressure head available to the user does not fluctuate**. The operating principle is illustrated below:

The return pressure value is brought to the bottom surface of the membrane (1) by means of the pressure test port (5); the flow pressure value is brought to the top surface of the membrane through the connecting passage (2) inside the control device (3). The pressure differential generates a force acting on the membrane (which tends to close), offset by the force exerted by a counter-spring (4) (which tends to open). The combined action of these two forces makes it possible to reach a condition of equilibrium that assures the required downstream conditions.

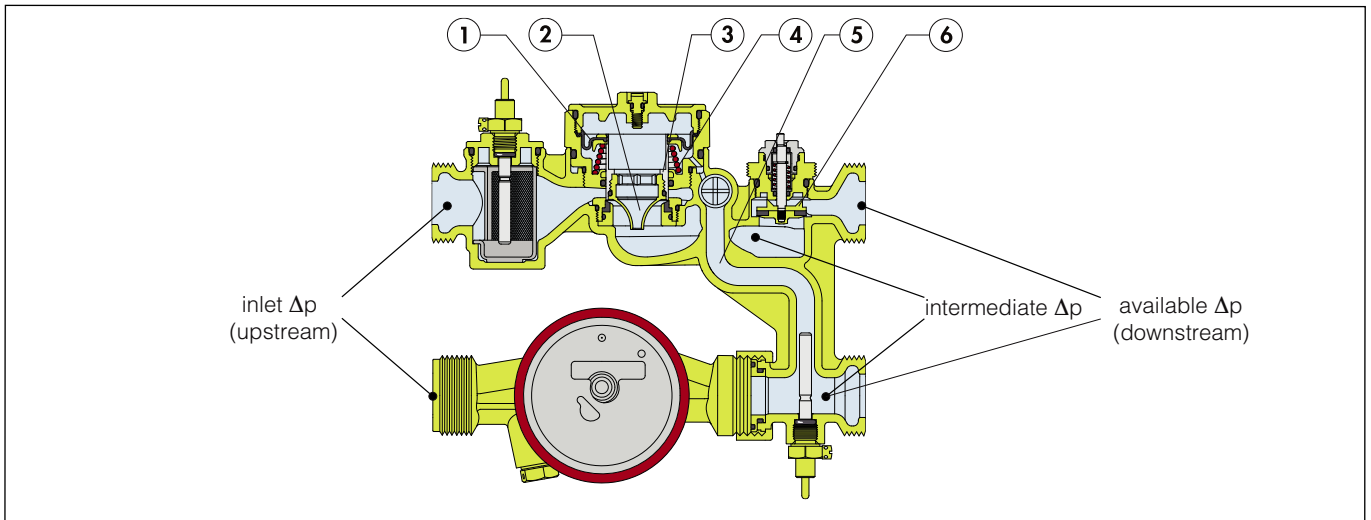

Automatic balancing

The Δp control valve effectively makes each outlet **hydraulically independent** from the centralised distribution network. This therefore removes the need for manual balancing of the zone branch. Controlling the available inlet head means controlling the maximum flow rate circulating in the system, in addition to providing protection **from potential noise phenomena** in each apartment.

Flow rate pre-adjustment

The hydraulic resistance downstream of the Δp limiter can be increased by means of the flow rate pre-adjustment device (6), using the specially shaped adjustment nut (R). The pre-adjustment device creates an additional controlled pressure loss that assists in setting a maximum flow rate limit.

In this context, once the technical specifications of the heating system to be served are known we can easily limit the maximum flow rate circulating in the apartment in accordance with the effective thermal load, the specifications of the heating bodies, and the design ΔT .

The thermo-electric actuator has to be removed before proceeding with flow rate adjustment.

N.B. The PLURIMOD EASY module is shipped with pre-adjustment set to position 4 - fully open.

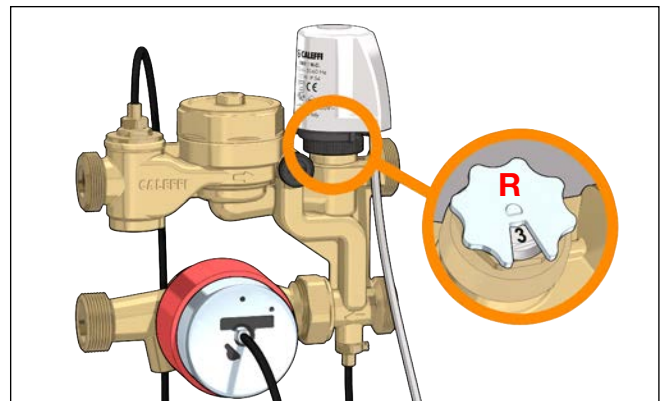

As a guideline, the correspondence between the pre-adjustment setting and the available flow rate is as follows (data in l/h) (*):

Position	1 m w.g. available		1.5 m w.g. available		2 m w.g. available		2.5 m w.g. available	
	2 m w.g. setting	3 m w.g. setting	2 m w.g. setting	3 m w.g. setting	2 m w.g. setting	3 m w.g. setting	2 m w.g. setting	3 m w.g. setting
1	250	450	180	375	-	300	-	220
2	440	720	300	620	-	500	-	350
3	760	1175	530	1000	-	800	-	560
4	1150	1500	800	1420	-	1200	-	860

 Δp limiter setting 2 m w.g.
code 700213/700214

 Δp limiter setting 3 m w.g.
code 700215/700216

(*) Tabulated values obtained empirically in the following conditions: $\Delta p_{in} = 60 \text{ kPa}$ for 3 m w.g. setting, $\Delta p_{in} = 40 \text{ kPa}$ for 2 m w.g. setting.

Hydraulic characteristics

Note: for more information consult **IDRAULICA** magazine issue no. 49 - December 2015

The setting differential pressure value (2 or 3 m w.g.) constitutes **the maximum head to which the downstream system is subjected**, in nominal flow rate conditions. The head effectively available at the system in the different pre-adjustment settings is shown in the following diagram (*):

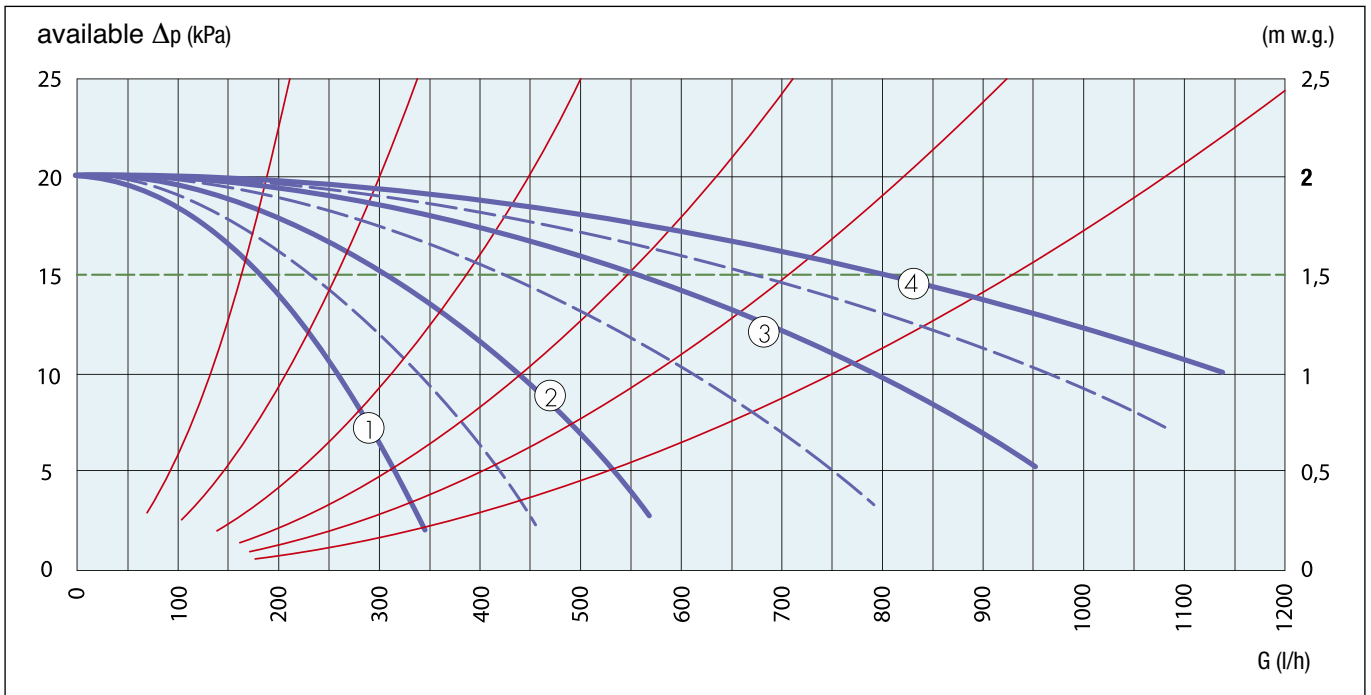

Hydraulic characteristics of PLURIMOD EASY modules code 700213/700214, with Δp limiter at 2 m w.g.

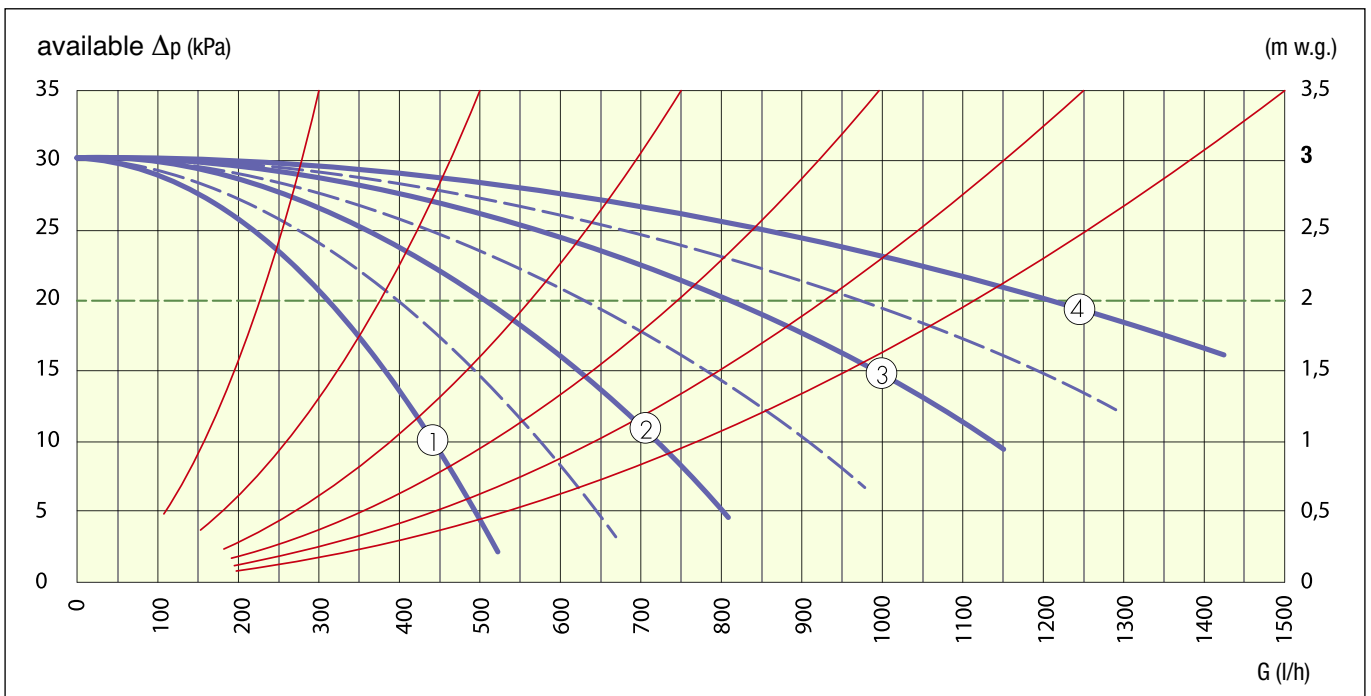

Hydraulic characteristics of PLURIMOD EASY modules code 700215/700216, with Δp limiter at 3 m w.g.

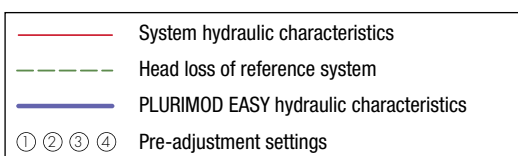

(*) To ensure that operating condition is possible and independent from the upstream conditions of the module, a **minimum head** must be provided such as to allow the differential pressure limiter device to operate within its working range.

For code 700213/700214 modules the minimum head is **3.5 m w.g.**, while for code 700215/700216 modules it is **5 m w.g.**

The curves are obtained empirically in the following conditions: $\Delta p_{in} = 60$ kPa for 3 m w.g. setting, $\Delta p_{in} = 40$ kPa for 2 m w.g. setting.

Setting of the maximum flow rate by means of the heat meter

Note: for more information consult **IDRAULICA** magazine issue no. 49 - December 2015

If the pressure loss of the heating system to be served is not known beforehand in precise terms, pre-adjustment can be **set experimentally** by using the **flow rate information provided by the heat meter**. It is anyway **necessary to check that the PLURIMOD EASY module's hydraulic characteristics are compatible with the system** where it will be used. The following diagrams show the operating conditions that can be obtained downstream of the modules code 700213/700214 (on the left) and modules code 700215/700216 (on the right).

1 - Perform the following preliminary steps:

HEATING SYSTEM WITH RADIATORS - After balancing the radiators by means of lockshield valves set the thermostatic valves to the **maximum opening position**.

HEATING SYSTEM WITH UFH/FAN COILS - After balancing the individual heading bodies/loops of the underfloor system, make sure that any thermoregulation devices, e.g. thermo-electric devices, **are in their fully open position**.

2 - Press the "PUSH" button on the CONTECA heat meter until reaching the flow rate page (see "user information cycle" paragraph on page 10).

3 - Turn the shaped nut and wait a few moments until the value shown on the display has stabilised. Adjustment is continuous so all intermediate settings are available. The stabilisation time is longer the smaller the circulating flow rate.

4 - Repeat the previous point until reaching the required design flow rate.

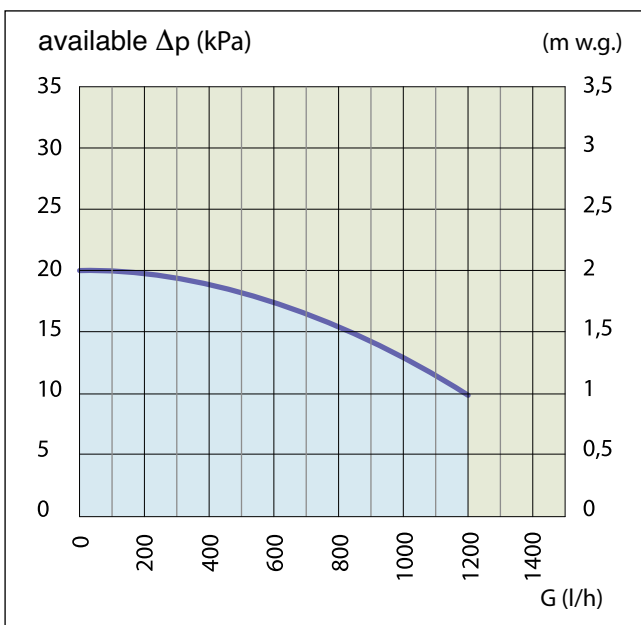

Flow rate range - available head obtainable for modules 700213/14 (setting 20 kPa, on lh side) and 700215/16 (setting 30 kPa, on rh side).

PLURIMOD EASY code 700213 - 700214. Δp max 2 m w.g.

Thanks to the presence of a two-way zone valve in combination with the built-in differential pressure control, PLURIMOD EASY is **the perfect solution for use in variable flow rate systems with thermostatic valves**. The version with Δp limiter at 2 m w.g. minimises the risk that operating conditions of partial closure of the thermostatic valves result in noise emission problems in the apartment. This differential pressure setting, combined with flow rate pre-adjustment, makes it possible to supply radiator type heating systems **with nominal flow rates of up to 800 l/h with 1,5 m w.g. available**, since it is suitable for both new buildings, typically featuring low thermal load, and for building renovation projects with higher capacity requirements.

PLURIMOD EASY code 700215 - 700216. Δp max 3 m w.g.

The version with Δp limiter at 3 m w.g. is configured as the **solution to be mainly employed for underfloor heating/cooling systems** featuring lower ΔT and hence higher required flow rates of **up to 1200 l/h with 2 m w.g. available**. The maximum available Δp of 3 m w.g. is compatible with this type of system because it is relatively immune from noise phenomena.

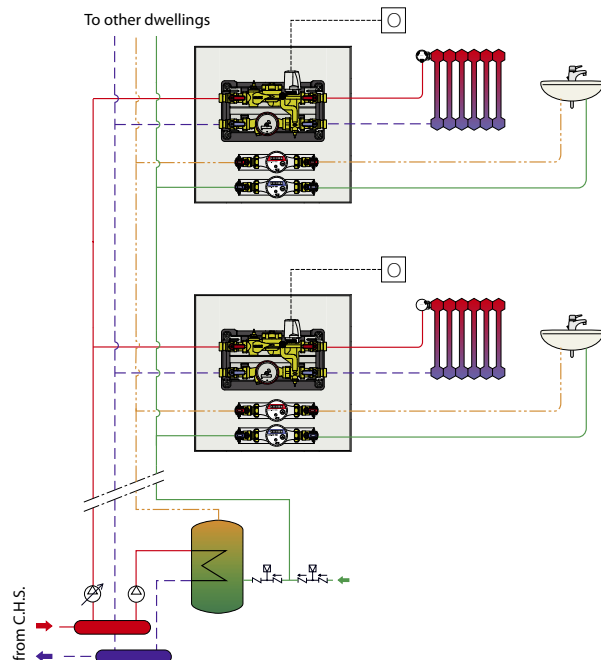

Recessed box for PLURIMOD EASY module code 700205

Recessed box with galvanised backplate and painted door 480x480 mm **for interiors**, RAL 9010; fitted with finishing frame with adjustable depth from 130 to 160 mm.

The template box (code 700205) is supplied complete with:

- technopolymer mounting bracket with thermal break
- 1 pair of 3/4" M ball valves with telescopic tailpiece
- 1 pair of 3/4" M standard ball valves
- 2 flushing pipes for initial system flushing. Tmax 55°C
- adhesive label indicating the flow direction (to be attached)
- cardboard to protect from rubble generated during the completion of construction work
- pre-formed insulation for PLURIMOD® EASY
- positioning guides for **the double domestic hot water function** code 700050/700051/700052/700053 and template for volume meter code 700009.



Dimensions

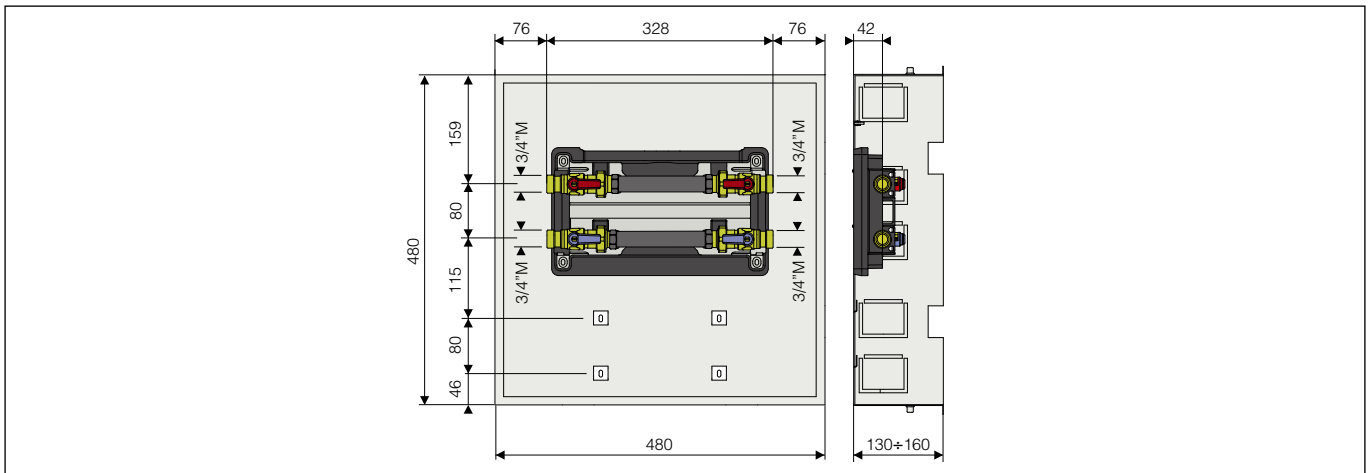

Positioning template box

The special shape of the template box means it can be installed in a variety of positions making it universal.

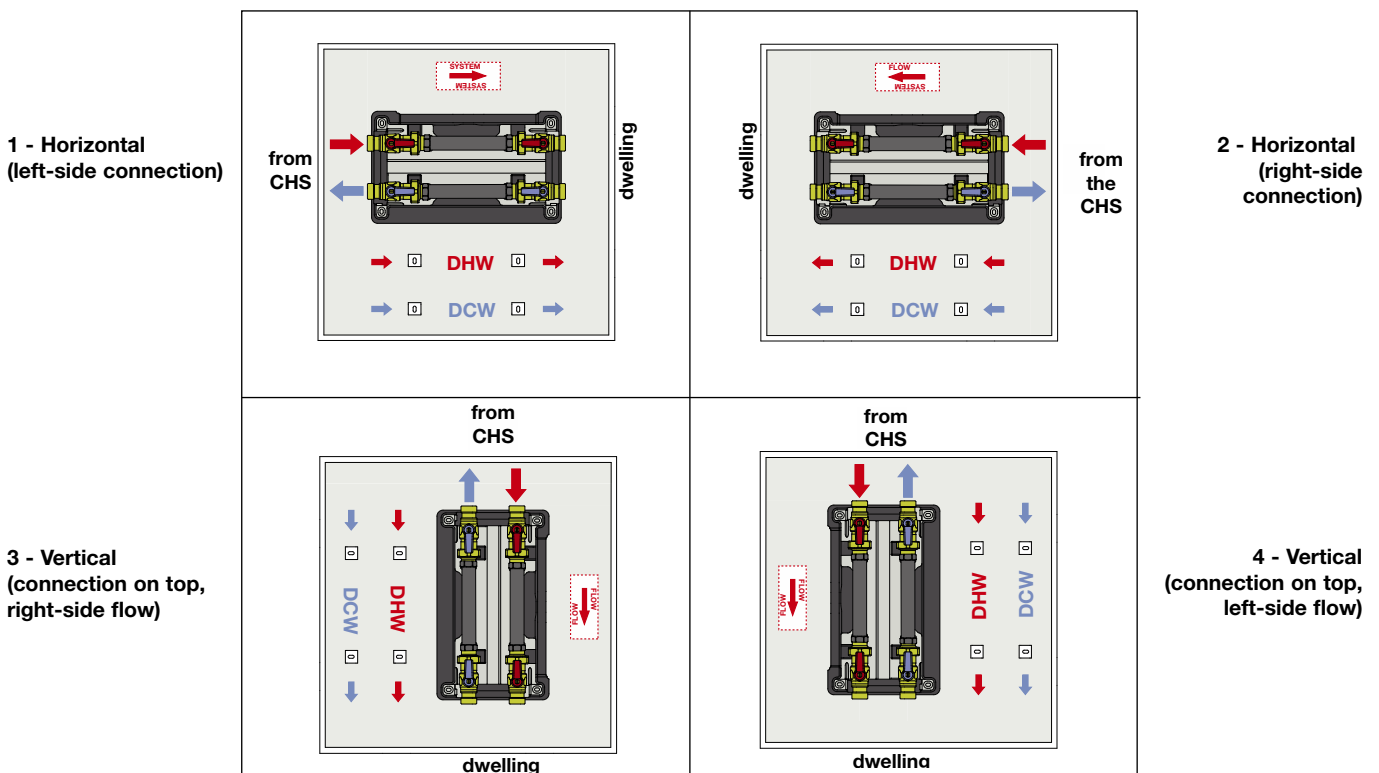

PLURIMOD EASY is fitted with all-over insulation (no thermal conduction on the brackets) making it absolutely compatible for combined heating and cooling systems.

Wall template for PLURIMOD EASY module code 700205 002

As an alternative to the recessed box code 700205 the PLURIMOD EASY hydraulic module can be installed in wall template code 700205 002.

The wall template is supplied complete with:

- technopolymer mounting bracket with thermal break
- 1 pair of 3/4" M ball valves with telescopic tailpiece
- 1 pair of 3/4" M standard ball valves
- 2 flushing pipes for initial system washing;
- adhesive label indicating the flow direction (to be attached);
- pre-formed insulation for PLURIMOD EASY.

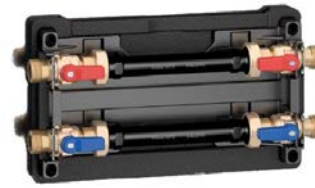

Dimensions

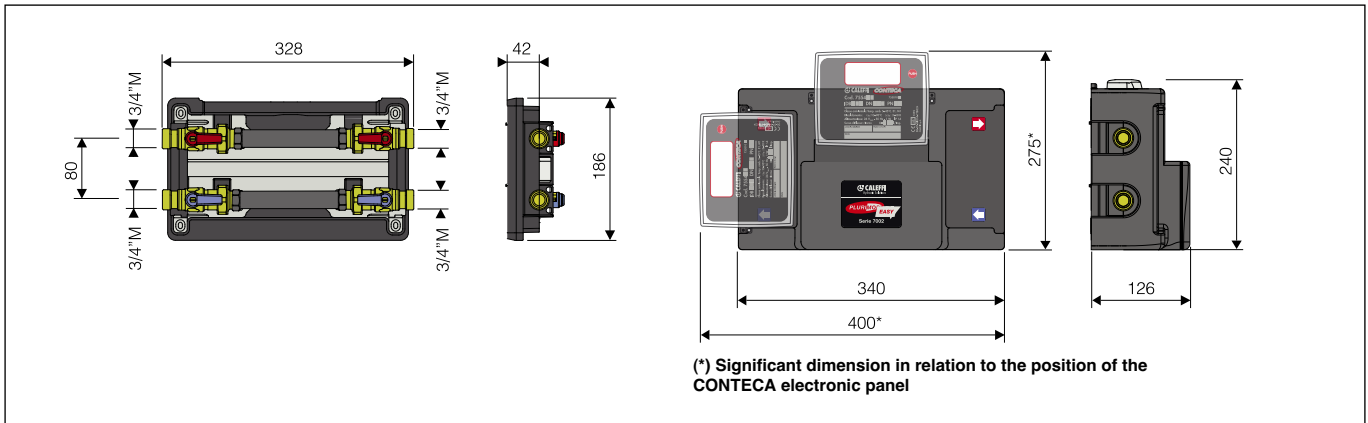

HYDRAULIC OPTIONS



7000

- Domestic water meter kit consisting of:
- BALLSTOP ball shut-off valve with **telescopic tailpiece**;
 - volume meter (MI001);
 - shut-off ball valve with male terminal;
 - flushing pipe.

Code

700050	DHW 3/4" with local reading
700051	DHW 3/4" with pulse output
700052	DCW 3/4" with local reading
700053	DCW 3/4" with pulse output



7942

Volume meter for domestic hot / cold water (MI001). With **pulse output**.

Domestic cold water (max. 30°C)

Code	Size	G _{nom} m³/h	Pulse weight l/pulse
794205	3/4"	2,5	10
794215	3/4"	2,5	Without pulse output

Domestic hot water (30–90°C)

Code	Size	G _{nom} m³/h	Pulse weight l/pulse
794205/C	3/4"	2,5	10
794215/C	3/4"	2,5	Without pulse output



700009

Template with 3/4" valves for domestic water volume meter.

Domestic water meter Conforms to directive 2004/22/EC (MI001)

	COLD WATER	HOT WATER
Size	3/4"	3/4"
Single jet meter	PN 16	
Continuous flow rate Q ₃	2500 l/h	2500 l/h
Maximum flow rate Q ₄	3125 l/h	3125 l/h
Working temperature range	0,1–30°C	30–90°C
Horizontal installation (H)		
Minimum flow rate Q ₁	50 l/h	50 l/h
Transitional flow rate Q ₂	200 l/h	200 l/h
Vertical installation (V)		
Minimum flow rate Q ₁	100 l/h	100 l/h
Transitional flow rate Q ₂	250 l/h	250 l/h
Max. % error for Q ₂ ≤ Q ≤ Q ₄	±2%	±3%
for Q ₁ ≤ Q ≤ Q ₂	±5%	±5%

- Note:**
- Before bracketing the domestic water kit to the template supports, check the direction of flow indicated on the BALLSTOP valve body.
 - Before bracketing the flow meter, check the direction of flow indicated on the meter body.

Note: The DHW/DCW functions are supplied separately. The presence of the template spacer makes it possible to **flush the water circuit at the initial installation (Tmax 55°C)**. The water flow meter **is provided** for subsequent hydraulic connection and electrical wiring to the CONTECA® electronic panel.

CONTECA METER

7554 series CONTECA heat meter.



Complies with Directive 2004/22/EC/MID
Accuracy class: 3 according to EN 1434



Note: for more options refer to [tech. broch. 01111](#)

Technical specifications

Temperature probe

Type: NTC
Temperature difference limit: 3÷80 K
Measurement sensitivity: ≤ 0,05°C

Volume meter

Nominal pressure: PN 10
Max. temperature of the medium: 90°C
Minimum flow rate Q_i: 50 l/h
Nominal flow rate Q_p: 2500 l/h

Calculation unit

Metrological specifications: EN 1434-1 compliant
MID 2004/22/EC

Centralised transmission: on RS-485 bus

Ambient classification: MID 2004/22/EC E1-M1

Electric supply: 24 V (ac) - 1 W - 50 Hz

Protection class according to DIN 40050: IP 54

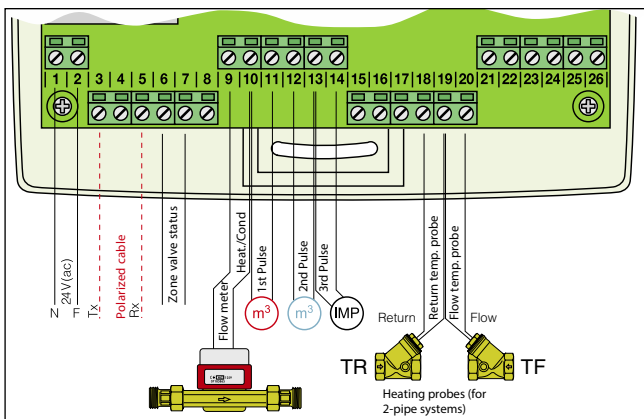

The CONTECA heat meter features a variety of metering and pulse acquisition settings which determine the predefined connection positions indicated below.

1) Heating and/or cooling unit metering

- 6 | 7 Zone valve status
- 9 | 10 Heating circuit flow meter
- 19 | 20 Flow probe (TM)
- 18 | 19 Return probe (TR)

2) Domestic water and/or general pulse acquisition (OA-OC type)

2.1) Single pulse flow meter

- 10 | 11 DHW or DCW (1st pulse consumption)

2.2) Two pulse flow meters

- 10 | 11 DHW (1st pulse consumption)
- 12 | 13 DCW (2nd pulse consumption)

User information cycle



The heat meter is equipped with a liquid crystal display. The display is activated by pressing the button on the front . By repeatedly pressing the button briefly, it is possible to scroll through the various information windows

Heating - Energy (Heating units)

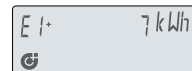

Cooling - Energy (Cooling units)



Heat transfer medium volume



1st pulse consumption (DHW)

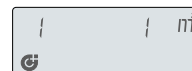

2nd pulse consumption (DCW)

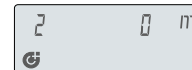

3rd pulse consumption (optional)

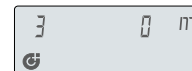

Flow rate

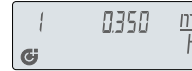

Power

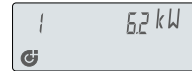

Flow temperature

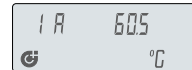

Return temperature

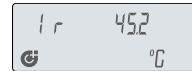

temperature difference

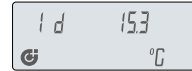

Bus network address

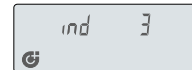

No. of tamper-proof system openings



Programming parameters flow rate meter



Checksum

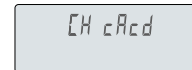

Segment test



ELECTRICAL-ELECTRONIC OPTIONS

755890 Remote energy totalizer



Remote digital energy totaliser for 7554 series meters. Equipped with cover plate for 3-slot recessed box. Dimensions: 120 x 80 x 60 mm. Maximum length of cable: 75 m. Use 2x1 shielded cable in a dedicated raceway.

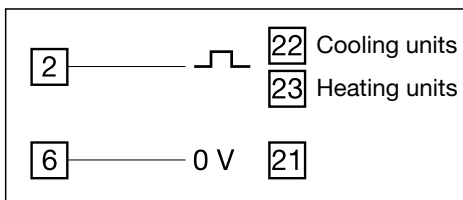

755810 Cooling metering

The CONTECA meter can be activated via software to **keep a record of consumption in heating and cooling mode in separate registers, by evaluating the sign of the temperature difference.**



Code

755810

75588. Pulse output

The pulse output enables transferral of the heating and/or cooling unit energy values to a generic logger. **The pulse weighs 1 kWh.** The pulse output with no potential is **open collector** with pulse time 120 ms - Vmax 24 V(dc).

Code

755881 single pulse output - HEATING

755882 double pulse output - HEATING/COOLING

DATA CENTRALISATION

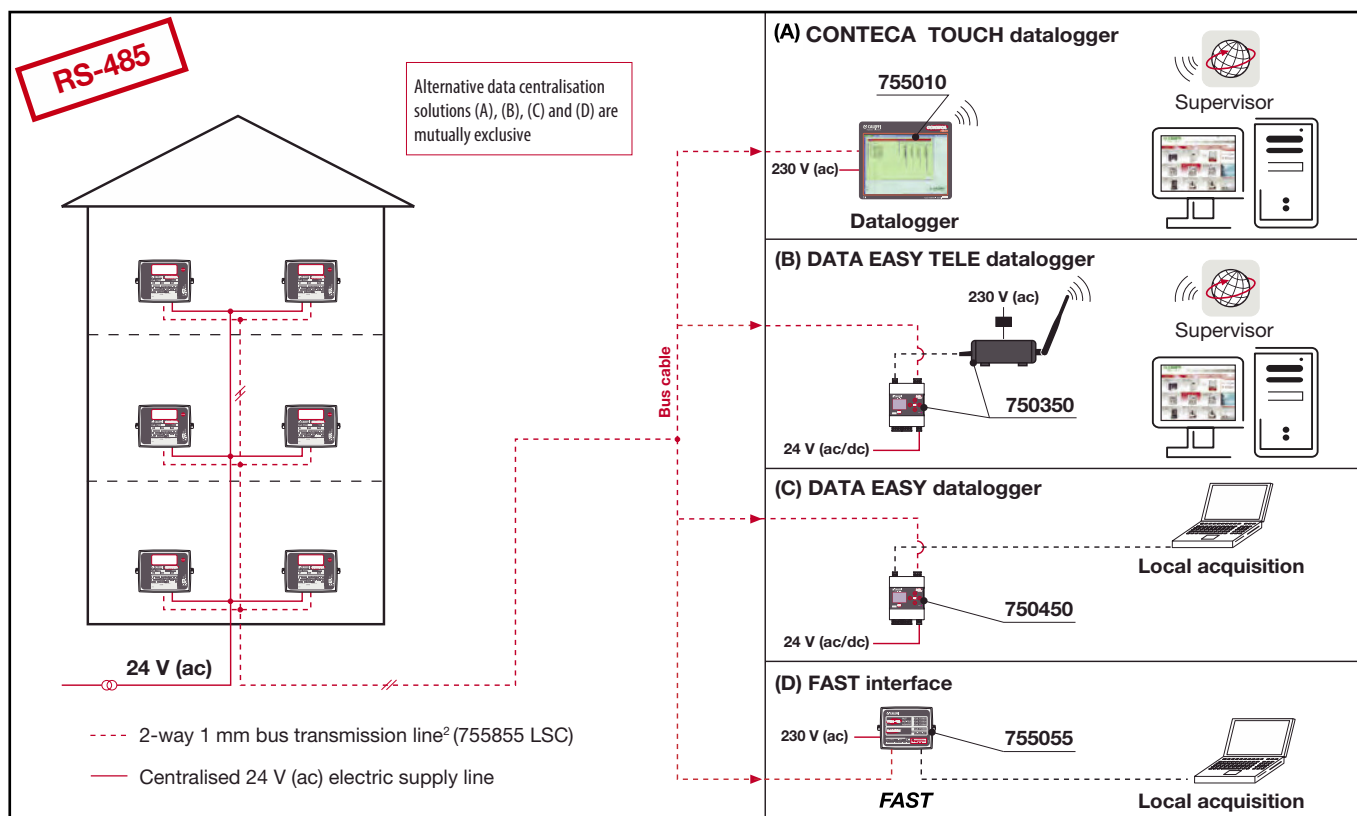

N.B.: The transmission bus code 755855 LSC is two-way (cross section 2 x 1 mm²). The datalogger allows **max. 250 users**. The methods for laying down are according to the tree distribution (star). The **maximum length** of each individual section is **1200 m**. It is possible to lay down **up to 4 separate sections**.

Note: for more information on metering refer to [tech. broch. 01111](#)

Installing the PLURIMOD EASY hydraulic module

Preliminary operations

Flushing the circuit is critically important to ensure correct operation of the system and avoid outages and potential metering errors.

The system must be flushed before installing the hydraulic module code 70021 using the two plastic pipes already installed on the template (flushing T_{max} 55°C);

At this stage, check the following:

- the 4 valves are fully open during flushing;
- the direction of the flow and return to the central heating system;
- the flow pipe must correspond to the red levers;
- the return pipe must correspond to the blue levers.

Hydraulic module positioning

PHASE 1:

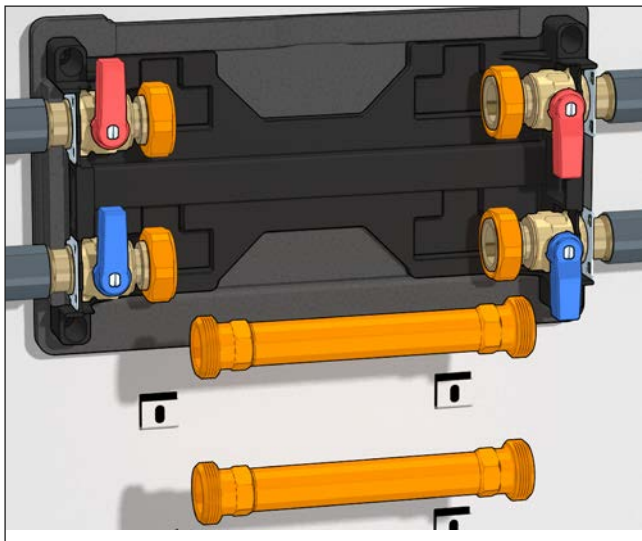

- remove the front part of the insulation;
- close all 4 shut-off valves;
- using caution, loosen the nuts highlighted in orange;
- remove the plastic flushing pipes and dispose of them as dictated by law.

PHASE 2:

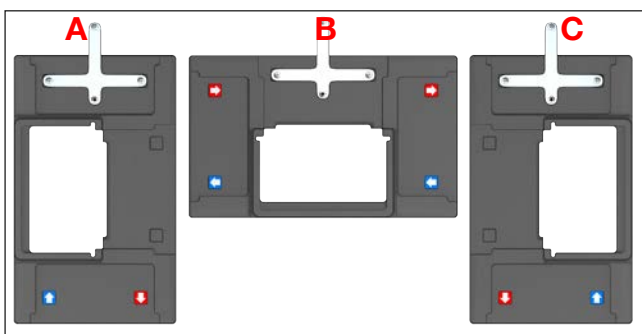

- Apply the CONTECA electronic panel mounting bracket to the front of the insulation in accordance with the type of installation of PLURIMOD EASY:
 - position A for vertical installation with right-side flow and downward flow direction (position 3 page 6);
 - position B for horizontal installation (pos. 1-2, page 6);
 - position C for vertical installation with left-side flow and downward flow direction (position 4 page 6).

PHASE 2bis (exclusively for installation with right-side riser):

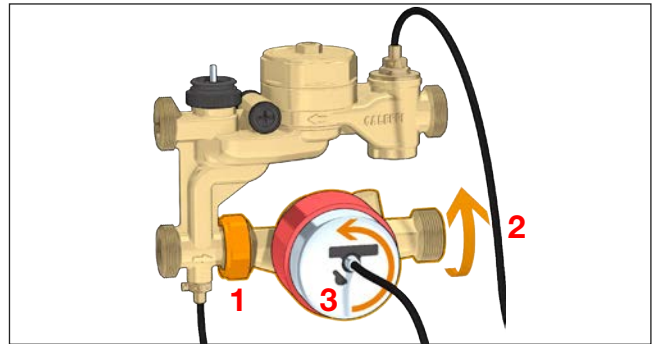

PLURIMOD EASY IS ALWAYS SUPPLIED FOR INSTALLATION WITH LEFT-SIDE RISER.

Follow the steps outlined below to position PLURIMOD EASY with right-side riser.

- 1 Using caution, loosen the nut highlighted in orange;
- 2 Turn the volume meter through 180°;
- 3 Rotate the dial
- 4 Tighten the nut

PHASE 3:

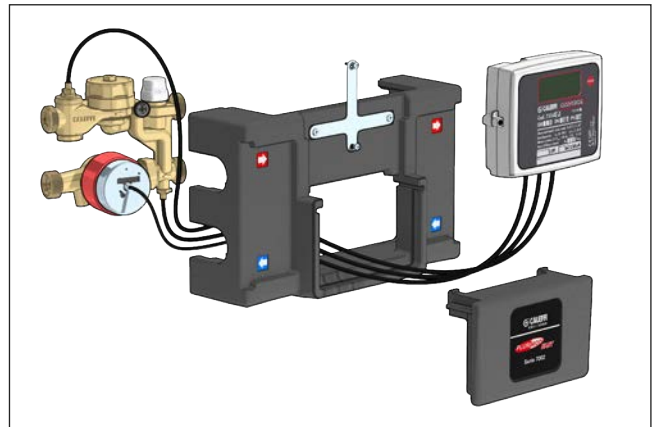

- Pass the CONTECA electronic panel through the front part of the insulation as shown in the figure.

PHASE 4:

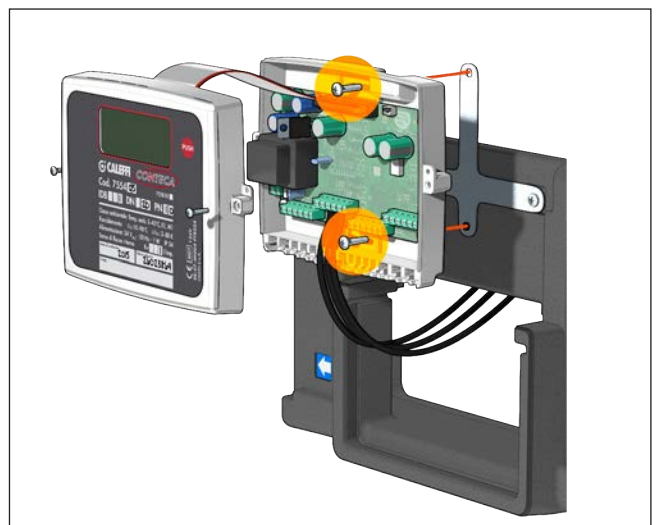

- Open the CONTECA electronic panel by removing the two lateral screws;
- Secure the rear part of the CONTECA electronic panel to the metal bracket installed previously (PHASE 2) by means of the screws supplied;
- Proceed with any **wiring of the water meters**, in accordance with the diagram on page 8;
- Re-close the CONTECA electronic panel using the previously removed screws.

PHASE 5:

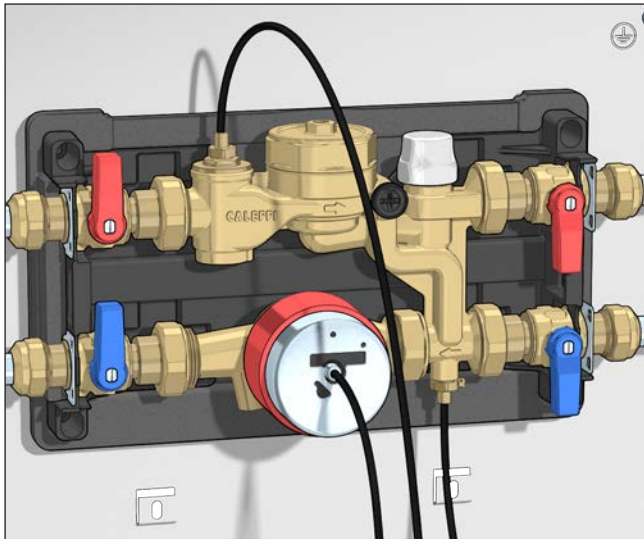

In this stage take care not to **stress the wiring** between the mechanical components and the CONTECA electronic panel.

- Keep the telescopic tailpieces at a distance to facilitate insertion of the hydraulic module;
- Line up the PLURIMOD EASY module and secure it using the 4 nuts attached to the valves; the seal is provided by O-rings on the valves;

N.B. When tightening the nuts take care **not to transmit torque to the brackets of the 4 shut-off valves**. While tightening the fittings the shut-off valves **must be immobilised**.

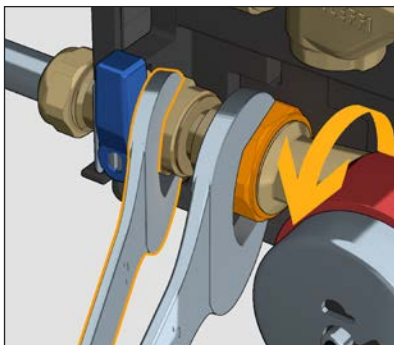

PHASE 6:

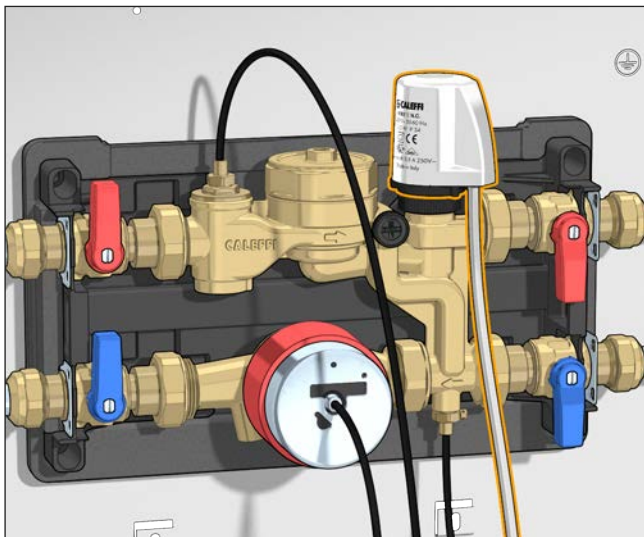

- Remove the plastic knob and fit the 6562 series thermo-electric actuator as shown in the figure.

PHASE 7:

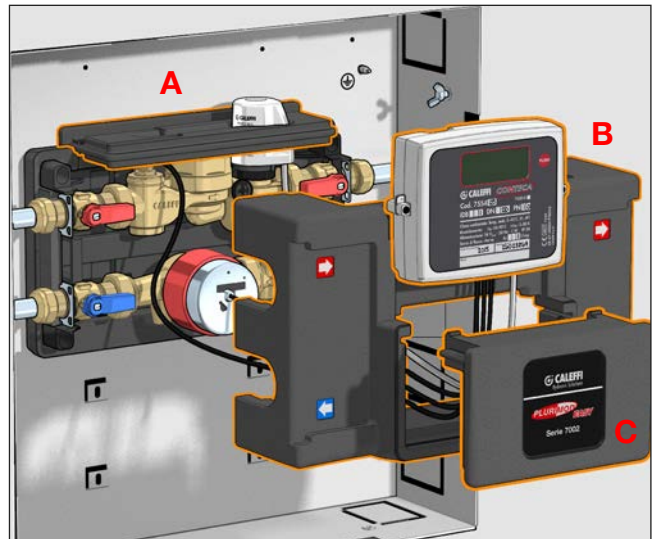

- Open the 4 shut-off valves and check the hydraulic seal visually;
- Vent the system, taking care to protect the electronic components from water droplets;
- Perform pre-adjustment of the maximum flow rate (page 4 - 5) and stow the key in the housing in the insulation;
- Position the upper part of the insulation (A) (the panel is reversible and suitable for any orientation of the hydraulic module);
- Position the front part of the insulation (B), on which the CONTECA electronic panel was previously positioned;
- Organise the wiring, also making use of cable ties, and arrange the cables inside the insulation;
- Fit the cover (C).

Final operations

Now connect any domestic water meters, the 24 V (ac) electric supply and the bus cable (if required).

To gain access to the circuit board and make all connections, unscrew the two slot bolts on the sides of the CONTECA plastic box.

Once all electric connections have been made and the CONTECA very carefully closed, use the sealing kit provided to seal the plastic container at the holes on the side near the bolts.

SPECIFICATION SUMMARY

Code 700205

Universal positioning recessed box with galvanised backplate and adjustable depth finishing frame composed of:

- painted sheet metal box for interiors (RAL 9010), with door fitted with universal closure system (l = 480 mm - h = 480 mm - d = 130–160 mm);
- 1 pair of 3/4" M ball shut-off valves with telescopic tailpiece;
- 1 pair of 3/4" M standard ball valves;
- 2 plastic pipes to check seal and flush system (Tmax 55°C);
- all-over insulation, rear and front, in black EPP (density 50 g/l, thermal conductivity 0,037 W/(mK) at 10°C), suitable for installation in heating and cooling systems;
- technopolymer mounting bracket with thermal break;
- cardboard to protect from rubble generated during the completion of construction work;
- guides for positioning 2 domestic water meters (DHW - DCW).

Code 700205 002

Universal positioning wall template consisting of:

- 1 pair of 3/4" M ball shut-off valves with telescopic tailpiece;
- 1 pair of 3/4" M standard ball valves;
- 2 plastic pipes to check seal and flush system (Tmax 55°C);
- all-over insulation, rear and front, in black EPP (density 50 g/l, thermal conductivity 0,037 W/(mK) at 10°C), suitable for installation in heating and cooling systems;
- technopolymer mounting bracket with thermal break;

Code 700213-700214

PLURIMOD EASY reversible installation (right - left) hydraulic module with 2-way zone valve with ON/OFF control and **fixed setting differential pressure control (2 m w.g. - 20 kPa)**, fitted with:

- 6562 series actuator, 230 V (ac) (for code 700213) or 24 V (ac) (for code 700214);
- CONTECA heat meter - EC 2004/22 certification (MID);
- pockets for heat meter direct immersion probes (flow pocket equipped with stainless steel strainer);
- maximum flow rate limiting device.

Code 700215-700216

PLURIMOD EASY reversible installation (right - left) hydraulic module with 2-way zone valve with ON/OFF control and **fixed setting differential pressure control (3 m w.g. - 30 kPa)**, fitted with:

- 6562 series actuator, 230 V (ac) (for code 700215) or 24 V (ac) (for code 700216);
- CONTECA heat meter - EC 2004/22 certification (MID);
- pockets for heat meter direct immersion probes (flow pocket equipped with stainless steel strainer);
- maximum flow rate limiting device.

Code 700050-700051-700052-700053

Domestic cold water (DCW) function, domestic hot water (DHW) function, consisting of:

- volume meter (MI001) Ø 3/4", without pulse output code 700050 (for hot water)/700052 (for cold water); with pulse output (K 10) code 700051 (for hot water)/700053 (for cold water);
- ball shut-off valve with integrated BALLSTOP check valve and telescopic tailpiece with 3/4" male terminal;
- ball shut-off valve with 3/4" male terminal;
- flushing pipe;
- mounting bracket.

Code 700009

Template for domestic water volume meter equipped with:

- ball shut-off valve with integrated BALLSTOP check valve and telescopic tailpiece with 3/4" male terminal;
- ball shut-off valve with 3/4" male terminal;
- flushing pipe;
- mounting bracket.

Code 794205-794215-794205/C-794215/C

Volume meter (MI001) Ø 3/4", with pulse output (k=10) code 794205/C (for hot water)/794205 (for cold water); without pulse output code 794215/C (for hot water)/794215 (for cold water).

We reserve the right to make changes and improvements to the products and related data in this publication, at any time and without prior notice.