

Multifunction hydraulic separator



5495 series

SEP 4



Function

The multifunction hydraulic separator combines different functional components, each of them to satisfy specific needs of air conditioning system circuits.

It is supplied complete with hot pre-formed shell insulation to ensure perfect thermal insulation when used with both hot and chilled water.

The device is designed to carry out the following functions:

- Hydraulic separation

To keep connected hydraulic circuits totally independent from each other.

- Deaeration

Utilises the combined action of several physics principles: the widening of the cross section decreases the flow velocity and the technopolymer mesh creates whirling movements so as to facilitate the release of micro-bubbles. The bubbles, fusing with each other, increase in volume and, rising towards the top of the unit, are released through a float-operated automatic air vent.

- Dirt separation

The dirt separator separates and collects any impurities in the circuits as they collide with the surface of the internal element.

- Removal of magnetic particles

The special patented magnetic system also attracts ferromagnetic impurities in the water: the ferromagnetic particles are trapped in the collection zone, meaning they are prevented from being recirculated.

Product range

5495 series Multifunction hydraulic separator with pre-formed insulation _____ sizes DN 25 (1"), DN 32 (1 1/4"), DN 40 (1 1/2"), DN 50 (2")

Technical specifications

Materials

Separator body:	epoxy resin coated steel
Automatic air vent body:	brass EN 12165 CW617N
Automatic air vent float:	PP
Automatic air vent hydraulic seals:	EPDM
Internal elements:	HDPE
Drain cock:	brass EN 12165 CW617N
Ring system magnetic induction:	2x0,3 T (DN 25, DN 32) 4x0,3 T (DN 40, DN 50)

Performance

Medium:	water, non-hazardous glycol solutions excluded from the guidelines of directive 67/548/EC
Max. percentage of glycol:	50%
Maximum working pressure:	10 bar
Working temperature range:	0–110°C

Connections

Separator:	1", 1 1/4", 1 1/2", 2" (ISO 7/1) F with union
Probe holder:	1/2" F at the front - maximum useful length: 35 mm (DN 25, DN 32) 50 mm (DN 40, DN 50)
Drain cock:	hose connection

Insulation technical specifications

Inner part

Material:	closed cell expanded PE-X
Thickness:	- threaded 20 mm
Density:	- inner part: 30 kg/m ³ - outer part: 80 kg/m ³
Thermal conductivity (ISO 2581):	- at 0°C: 0,038 W/(m·K) - at 40°C: 0,045 W/(m·K)
Coefficient of resistance to water vapour (DIN 52615):	> 1300
Working temperature range:	0–100°C
Reaction to fire (DIN 4102):	class B2

Dimensions

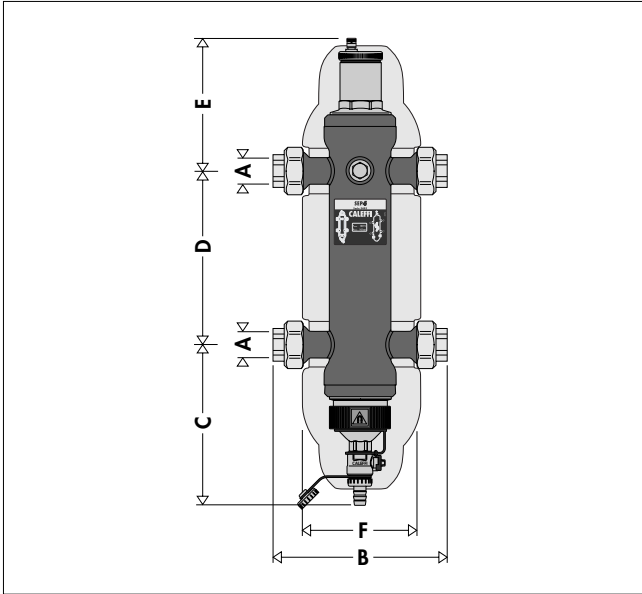

Code	Size	A	B	C	D	E	F	Mass (kg)
549506	DN 25	1"	225	202	220	154	120	4
549507	DN 32	1 1/4"	248	202	240	144	120	5
549508	DN 40	1 1/2"	282	242	260	180	180	10
549509	DN 50	2"	315	236	300	184	180	14

Volumes

Size	DN 25 (1")	DN 32 (1 1/4")	DN 40 (1 1/2")	DN 50 (2")
Volume (l)	1,7	2,6	4,8	13,5

Hydraulic characteristics

The multifunction hydraulic separator should be sized in accordance with the maximum recommended flow rate value at the inlet. The selected value should be the sum of the primary circuit flow rates or the sum of the secondary circuit flow rates, whichever is greater.

Size	DN 25 (1")	DN 32 (1 1/4")	DN 40 (1 1/2")	DN 50 (2")
Flow rate (m/h)	2,5	4	6	8,5

Operating principle

When a single system contains a primary production circuit, with its own pump (or more than one), and a secondary user circuit, with one or more distribution pumps, operating conditions may arise in the system whereby the pumps interact, creating abnormal variations in circuit flow rates and pressures.

The hydraulic separator creates a zone with low head loss, which enables the primary and secondary circuits connected to it to be hydraulically independent of each other; **the flow in one circuit does not create a flow in the other if the head loss in the common section is negligible.**

In this case, the flow rate in the respective circuits depends exclusively on the flow rate characteristics of the pumps, preventing reciprocal influence caused by their connection in series.

Therefore, using a device with these characteristics means that the flow in the secondary circuit only circulates when the relevant pump is on, permitting the system to meet the specific load requirements at that time.

When the secondary pump is off, there is no circulation in the secondary circuit; the whole flow rate produced by the primary pump is by-passed through the separator.

With a hydraulic separator, it is therefore possible to have a production circuit with a constant flow rate and a distribution circuit with a variable flow rate; these operating conditions are typical of modern heating and air-conditioning systems.

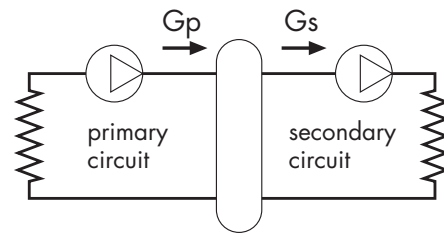

Three possible hydraulic balance situations are shown below. **For more detailed information on the temperature variations caused by the separators, please consult the Caleffi Idrastica magazine nr. 18, pages 7 to 11.**

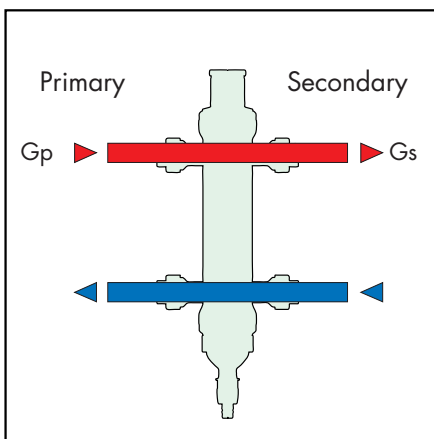

$G_{\text{primary}} = G_{\text{secondary}}$

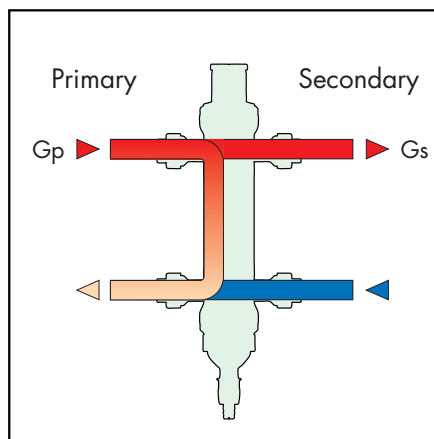

$G_{\text{primary}} > G_{\text{secondary}}$

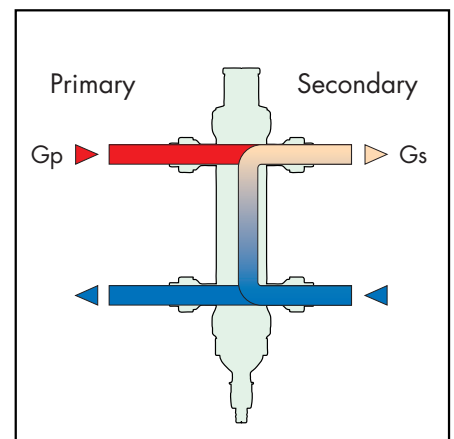

$G_{\text{primary}} < G_{\text{secondary}}$

Construction details

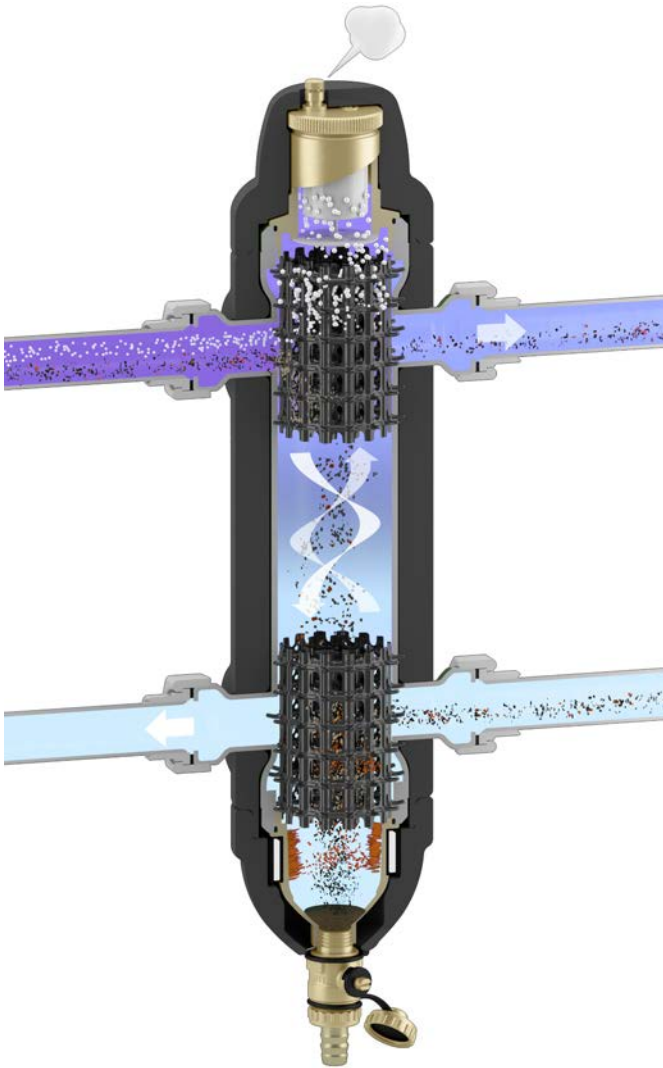

Deaerator element

At the top of the device a deaerator element is able to separate air particles within the system, right down to micro-bubble level.

Air release takes place via the automatic air vent positioned at the top of the multifunction separator.

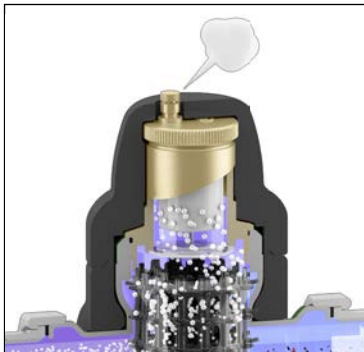

Dirt separator element

Another function of the multifunction hydraulic separator is carried out by the dirt separator element inside the device. This is used to separate and collect any impurities present in the system.

These impurities are eliminated via the drain valve at the bottom (this can be opened while the system is operating), which can be connected to a discharge pipe.

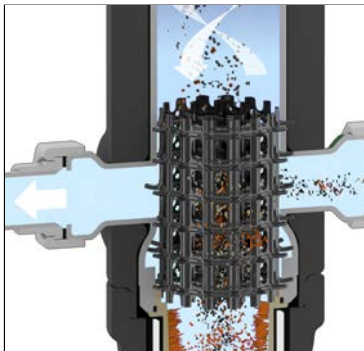

Magnetic element

The magnet positioned towards the bottom of the device offers greater efficiency in the separation and collection of ferrous impurities.

The impurities are trapped inside the separator body by the strong magnetic field created by the magnets inserted in the special outer ring.

The outer ring can also be removed from the body to allow the decantation and subsequent expulsion of sludge while the system is still running. Since the magnetic ring is positioned outside the separator body, the hydraulic characteristics of the device are not altered.

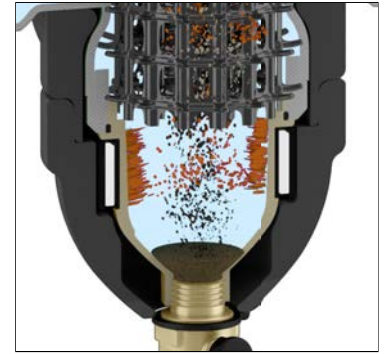

Sludge discharge

To discharge sludge, simply remove ring (A) housing the magnets which captured the ferrous impurities during dirt separation phase.

Next, carry out the discharge procedure by opening ball shut-off cock (B) using the special key provided (C).

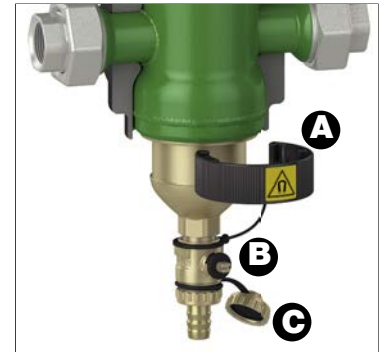

Probe holder connections

The range of separators has a 1/2" probe holder connection, for use with temperature probes or temperature gauges.

Insulation

The separators are supplied complete with hot pre-formed closed-cell expanded PE-X shell insulation. These types of insulation ensure not only perfect thermal insulation, but also the tightness required to prevent atmospheric water vapour from entering the unit. For these reasons, these types of insulation may also be used in chilled water circuits as they prevent condensation from forming on the surface of the valve body.

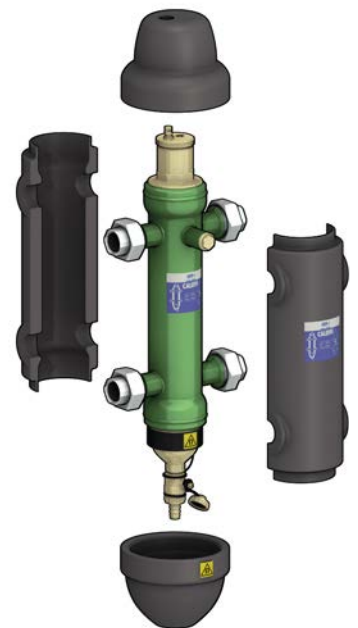

Application diagram

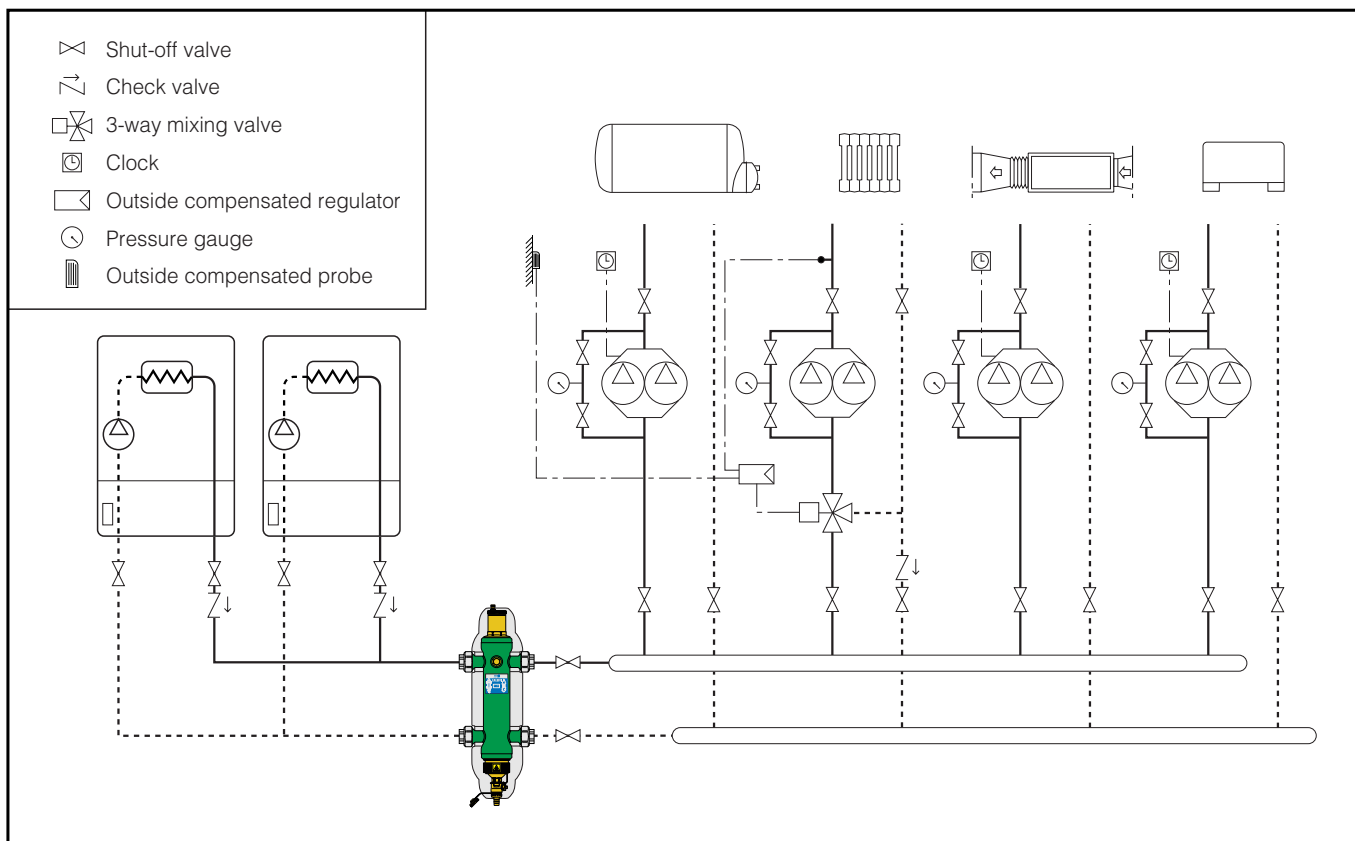

SPECIFICATION SUMMARY

5495 series

Multifunction hydraulic separator. Size DN 25 (from DN 25 to DN 50). Connections 1" (ISO 7/1) F (from 1" to 2") with union. Epoxy resin coated steel body. Medium water and non-hazardous glycol solutions excluded from the guidelines of directive 67/548/EC. Maximum percentage of glycol 50%. Maximum working pressure 10 bar. Working temperature range 0–110°C. Supplied with:

- automatic air vent. Brass body. PP float. EPDM hydraulic seals.
- discharge valve. Hose connection. Brass body.
- 1/2" F front probe holder connection.
- closed cell expanded PE-X hot pre-formed shell insulation. Working temperature range 0–100°C

We reserve the right to make changes and improvements to the products and related data in this publication, at any time and without prior notice.