

# Ball shut-off valve fitted for integrated flow rate measuring sensor



01234/13 GB

## 111 series



### Function

The valve allows to shut the circuit off and is fitted for the installation of the integrated flow rate measuring sensor. In addition to the accuracy and simplicity of regulation, this system features very low head losses and does not obstruct the medium flow.

The shut-off valve consists of a ball valve, that can be adjusted using the cap, and a control lever. The cap in composite material was designed to assure a perfect hydraulic seal, thanks to the positioning lugs and seal ring.

**The 111 series shut-off valve can only be fitted with the 110 series geothermal manifold.**

PATENT PENDING

### Product range

111 series	Shut-off valve	sizes DN 25 (Ø 25), DN 32 (Ø 32), DN 40 (Ø 40)
Code 111001/3	Insulation for shut-off valves	
Code 130010	Flow rate electronic measuring station with Vortex effect	
Code 111010	Flow rate integrated measuring sensor with Vortex effect	
Code 111002 series	Control lever for shut-off valves	

### Technical specifications

#### Materials

Body:	brass EN 12165 CW617N
Cap:	PA66G30
Seal ring:	stainless steel

#### Performance

Medium:	water, glycol solutions, saline solutions
Max. percentage of glycol:	50%

Max. working pressure:	6 bar
System test pressure:	10 bar
Working temperature range:	-10–40°C
Ambient temperature range:	-20–60°C

Connections:	
- to manifold:	with captive nut 42 p.2,5 TR
- to pipe:	DN 25, DN 32, DN 40

#### Vortex-effect sensor

Accuracy of flow rate reading:	±10%
--------------------------------	------

#### Insulation

Material:	closed cell expanded PE-X
Thickness:	10 mm
Density: - inner part:	30 kg/m <sup>3</sup>
- outer part:	80 kg/m <sup>3</sup>
Thermal conductivity (DIN 52612): - at 0°C:	0,038 W/(m·K)
- at 40°C:	0,045 W/(m·K)
Coefficient of resistance to water vapour (DIN 52615):	> 1300
Working temperature range:	0–100°C
Reaction to fire (DIN 4102):	class B2

### Hydraulic characteristics

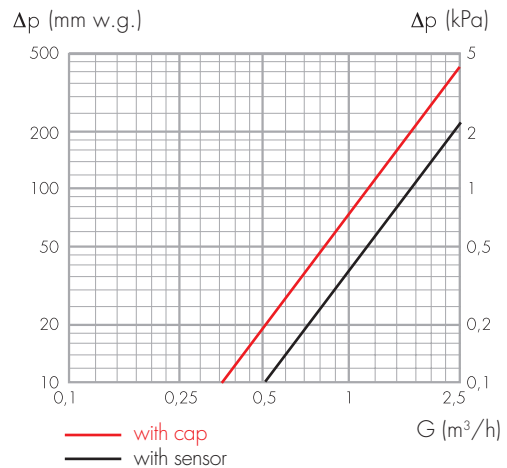

### Dimensions

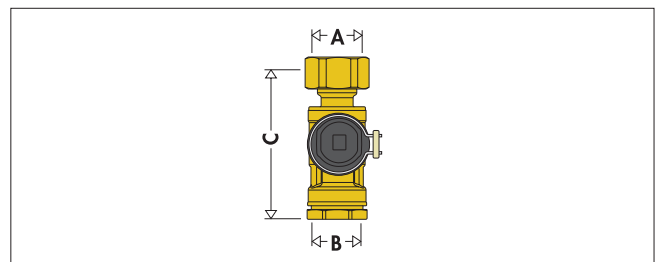

Code	A	B	C	Mass (kg)
111620	42 p.2,5 TR	Ø 25	117	0,985
111630	42 p.2,5 TR	Ø 32	118	0,922
111640	42 p.2,5 TR	Ø 40	153	1,288

## Operation

### Shut-off

The control knob (1) opens and closes the ball valve. The knob must be positioned parallel to the chamfers (2) of the cap, and aligned with the slots, so as to correctly guide the cap.

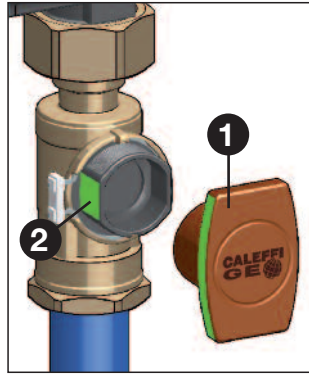

When the control knob is in the vertical position, the ball is open and the medium is flowing (A). When the lever is in the horizontal position the ball is closed: the seats ensure a tight seal and impede the medium flow (B).

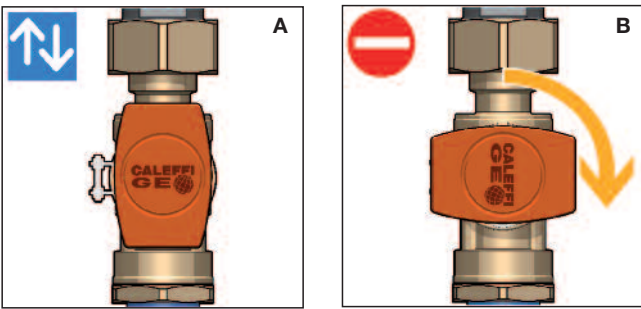

### Using the Vortex-effect sensor

The shut-off valve is fitted for the installation of the integrated flow rate measuring sensor with Vortex effect.

The sensor is mounted on a composite material body, similar to the cap and can be fitted instead of the latter during flow rate measuring and balancing phase. The ball was in fact designed to accommodate the sensor.

### Shut-off valve with cap.

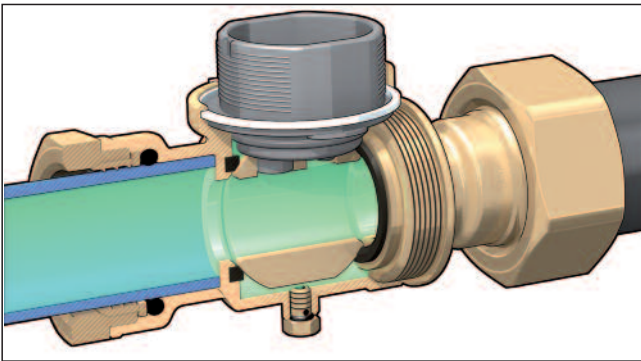

Shut-off valve with Vortex-effect sensor: ball in open position. The circuit can be balanced.

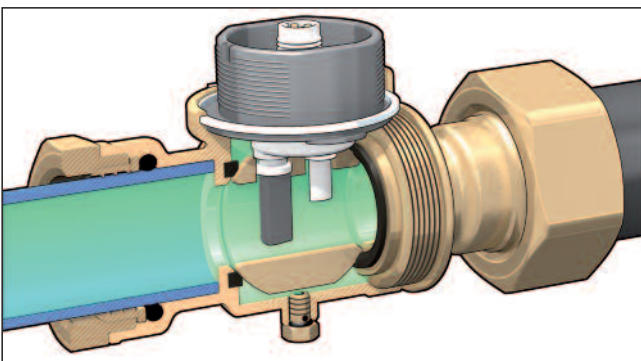

Balancing with the Vortex sensor has many advantages:

- The measurement and regulation system does not remain installed in the system but can be removed, after the balancing operation are concluded, and can be kept by the installer.
- During normal operation, the shut-off valve has no moving parts subject to wear over time and head losses are negligible.
- The measuring device is not affected by changes in temperature, pressure or viscosity.

### Measurement principle

The flow rate metering devices, based on the vortex precession (Vortex effect), work according to the Karman principle. When a fluid in movement hits an obstacle (normally called a stocky object), vortices take origin and separate from both sides, rotating in the opposite direction. Each vortex generates a localized low pressure. Variations in pressure are picked up by the sensor and converted into electrical pulses.

Analysis electronics are used to process and analyse the metering device pulses and translate them into a numerical flow rate value.

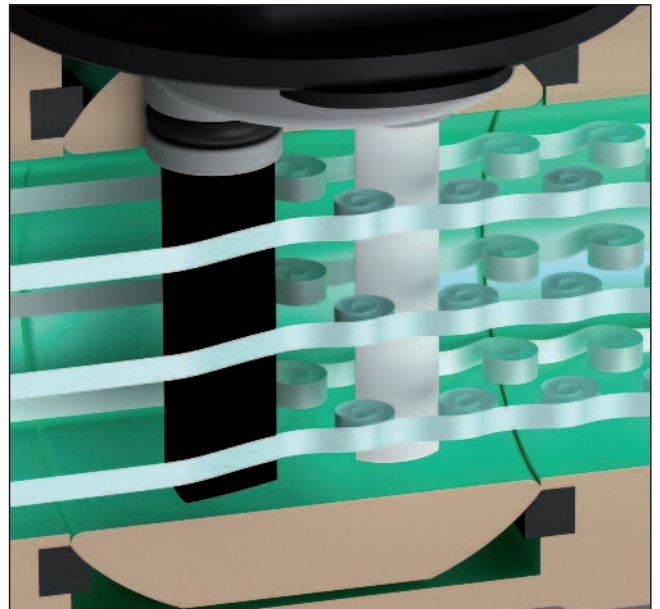

### Construction details

To fit the cap correctly to the valve body, line up the two lugs (1) on the cap with the slots (2) on the cap with the slots (2). When opening the ball, the lugs slide under the seal guide and avoid the cap to be extracted when the ball is open.

The cap has a special shape to assure perfect union with the ball and to prevent any obstructions within the useful flow section.

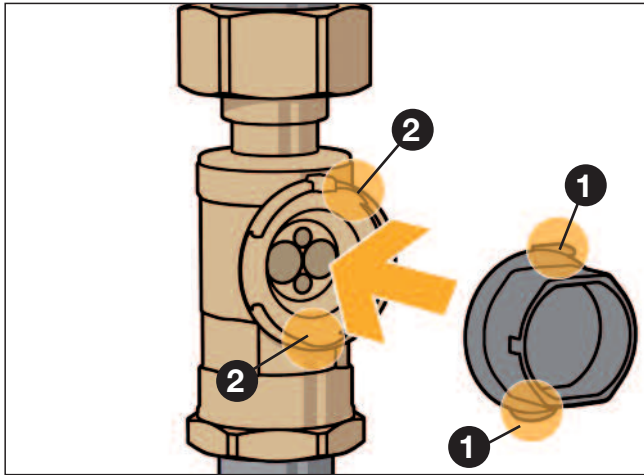

The clip (3), inserted after the cap or sensor are in position, anchors the unit securely to the valve body. The clip is firmly restrained in its seat and subsequently the correct position is assured by a spacer (4).

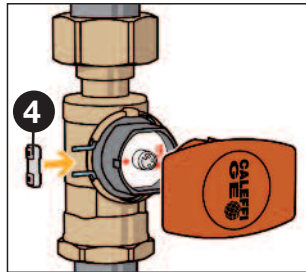
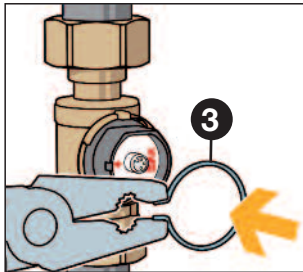
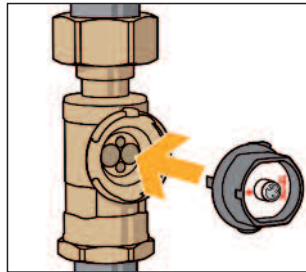

In horizontal installations, liquid above the ball could impede the correct positioning of the sensor in the valve body. For this reason, the valve body is equipped with a cock on the rear (5) to discharge the fluid, contained inside the ball, when this is in the closed position.

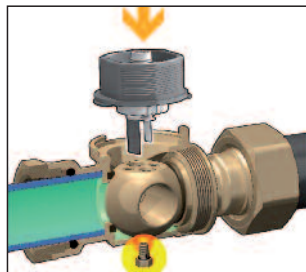
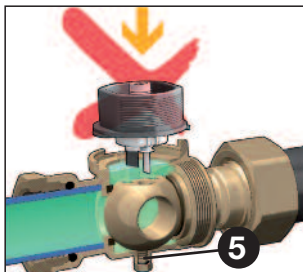

### Insulation

The balancing valve can be combined with the closed cell expanded PE-X insulation (111 series) which provides perfect thermal insulation and is particularly useful for limiting heat loss in geothermal installations.

To facilitate maintenance and circuit shut-off, the insulation is equipped with a velcro closing thus avoiding the usual glueing.

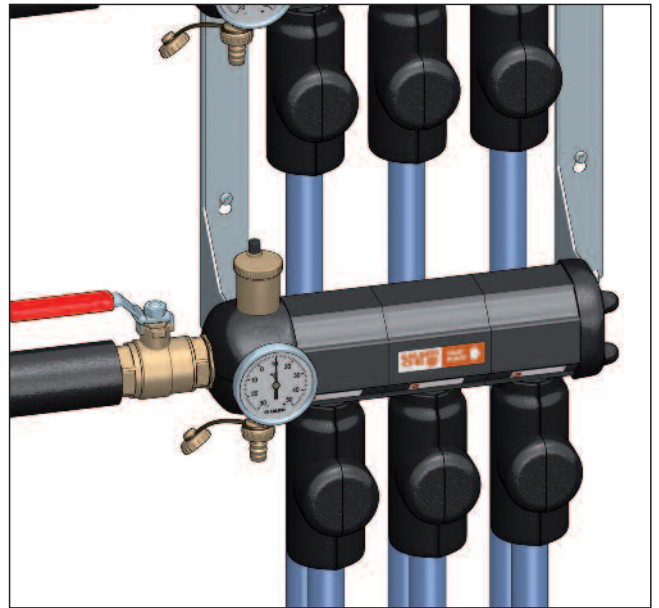

### Connection to geothermal pipe

The geothermal circuit pipe can be connected straight to the shut-off valve via the polyethylene pipe fitting.

These fittings are extremely practical as they do not have to be disassembled when joining pipes and are not affected by frost, hence any deformations are absorbed by the pipe itself.

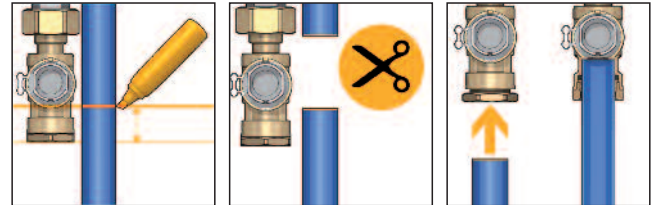

### Flexible installation

The versatility of the shut-off valve and flow rate measurement system means it can be installed both vertically, anchored to a wall, or horizontally in an outdoor well, for example.



## Circuit balancing

To swap the cap with the sensor it is necessary to:

1. Close the valve with the knob.
2. Remove the lock, the clip and extract the cap.

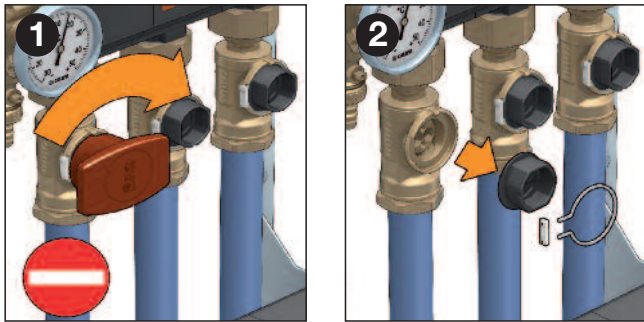

3. Insert the flow rate sensor and secure it with the clip and the lock.
4. Reopen the valve with the knob.

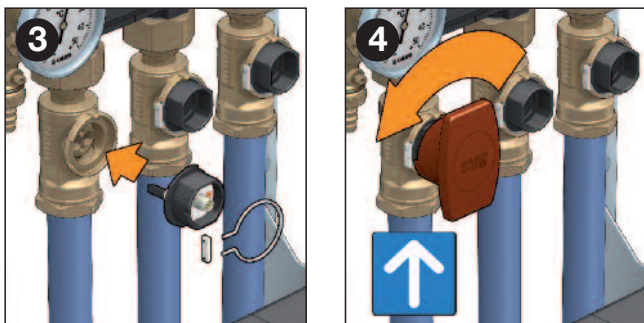

5. After carrying out these operations on all the outlets, it is possible to connect the electronic measurer to the sensor for the first branch and measure the corresponding flow rate. Flow rate regulation is performed by using the special knob to control the shut-off valve on the return manifold in correspondence with the same circuit, until the instrument indicates the design setting.

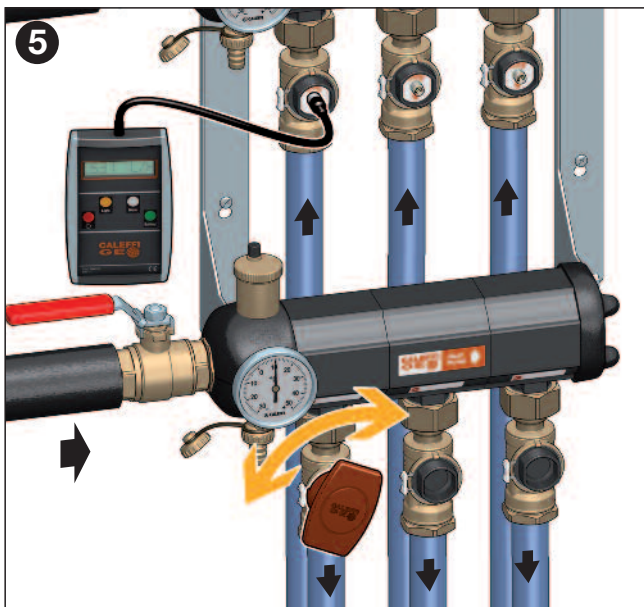

6. This operation must be repeated on subsequent branches to obtain the desired flow rate.

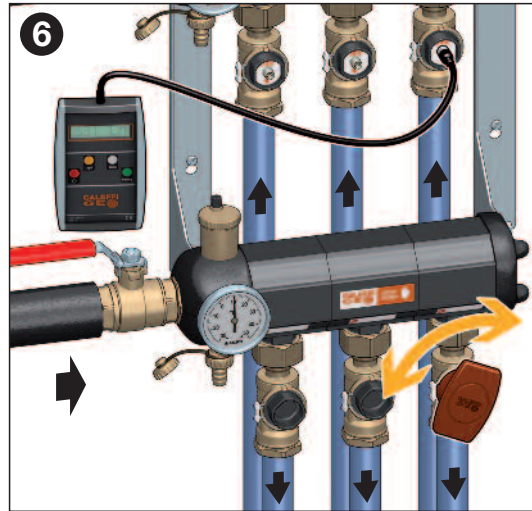

While measuring the flow rate, the sensor creates no significant head losses and therefore causes no significant changes in the actual flow rate.

After balancing, disconnect the electronic meter and put the shut-off valves back into their standard operating condition as follows:

7. Close the valve with the knob.
8. Remove the lock, the clip and extract the sensor.

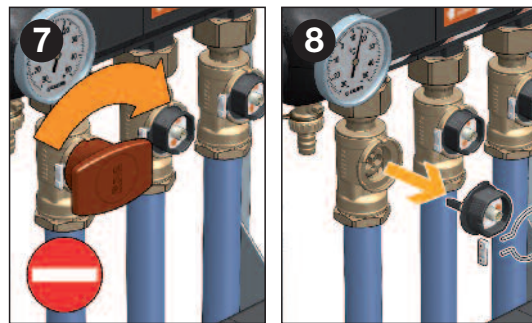

9. Fit the cap back in and secure it with the clip and the lock.
10. Reopen the valve with the knob. Repeat the above operations for all circuits.

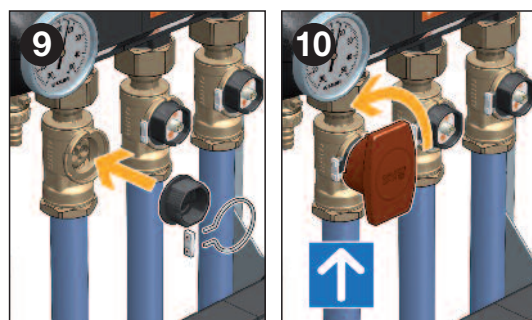

## Electronic flow rate meter

The 130 series electronic flow rate measuring station was designed to be easily set up and allow the flow rate to be quickly read.

The flow rate measuring station measures the instantaneous flow rate inside a pipe: in particular, the device was designed to work with 111 series sensors. The electronic measuring station calculates the average medium speed using the "Von Karman" effect that the sensor creates in the flow.

It is also programmed with data regarding the flowing surface of the medium and conversion factors needed to be able to calculate the instantaneous flow rate.



## Technical specifications

### Measuring device

Display: alphanumeric with white backlighting  
 Minimum flow rate: 300 l/h  
 Maximum flow rate: 1400 l/h  
 Maximum error:  $\pm 10\%$   
 Units of measurement available: l/h, l/min, GPM  
 Liquids used: water, glycol solutions (up to 50%)  
 saline solutions  
 Electric supply: internal 9 V NiMh battery

### Battery charge

Electric supply: 230 V~50 Hz  
 Output: 18 V (dc)  
 Max. current consumption  
 by the device in charge (18 V): 50 mA  
 Maximum power output of the supply unit: 6 W  
 Connection: audio jack 3,5 mm

The battery charge is expressed as a % from 100% to 0%: when the battery charge is too low the device should be charged up.

The measuring station also functions effectively when charging, hence it can even be used when connected to the battery charger.

During the charging phase, pressing the "Battery" button displays the "BATTERY CHARGE" indication.

## User interface

- 1) Display showing flow rate
- 2) "ON/OFF" button ●
- 3) "Light" button ●
- 4) "Menu" button ○
- 5) "Battery" button ●
- 6) Sensor connection socket
- 7) Battery charger connection socket

The device has an LCD display showing flow rate during measurement, configuration menus and other information needed for the correct use.

To switch on the measuring station, just press and hold the ● ON button until words appear on the display. To switch the device off, just press and hold the ● ON button until all words on the display disappear. If no keys are pressed for 4 minutes, the device automatically switches off even if the sensor is still connected: this prolongs the life of the internal battery.

Pressing the "Light" ● button switches on or off the display backlighting, enabling it to be used in dark places with no lighting. The backlighting is switched off automatically after 1 minute to prolong battery life.

Pressing the ○ button allows to enter and browse the configuration menu. On exiting the menu page, it returns to the measurement display.

Pressing the ● button from the measurement screen shows the status of the device's internal battery. To go back to the measurement screen, press the ● button again.

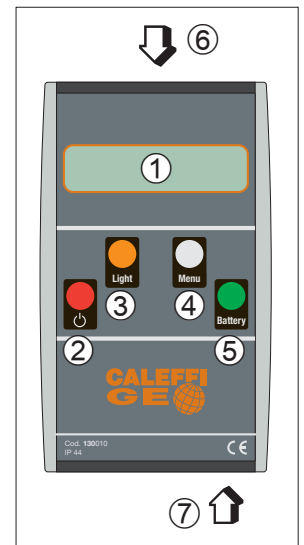

## Dimensions

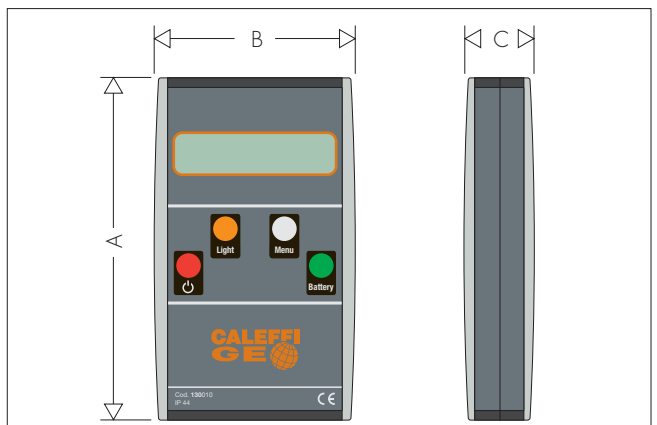

Code	A	B	C	Mass (kg)
130010	155	96	29	0,220

## Browsing menus and device configuration

The device is equipped with three buttons:

- "Menu"
- "Battery"
- "ON/OFF"

Use the "menu" button ○ to browse items in the main menu, whilst pressing the "Battery" ● button will open sub-menus. To exit the menu and go back to measurement mode, use the "Battery" ● button.

Press the "ON/OFF" ● button to exit, to return to the previous menu or measurement mode.

The menu is structured as illustrated below.

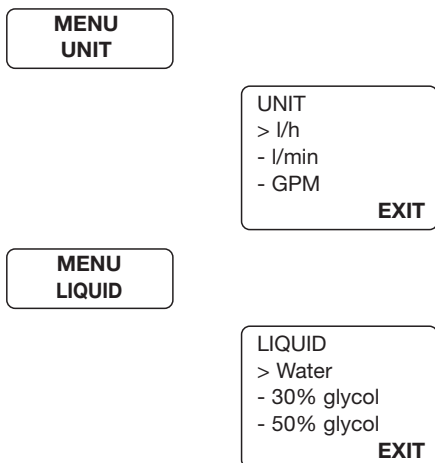

MENU  
VERSION

CALEFFI S.p.A.  
I° 001  
SW 0/10 HW 0/10  
Reset  
EXIT

When browsing menus, inactive headings are shown with a minus sign ("-") whilst active headings have a cursor (">"). Take the following unit of measurement for instance, i.e. "l/min":

### UNIT OF MEASUREMENT

- "Battery" → - l/h
- "Menu" → > l/min
- "Menu" → - GPM

## SPECIFICATION SUMMARY

### 111 series

Ball shut-off valve fitted for integrated flow rate measuring sensor with Vortex effect. Brass body. Upper cap in composite material. Female connections with trapezoidal thread captive nut 42 p.2,5 mm and fitting for polyethylene pipe Ø 25, Ø 32, Ø 40. Maximum working pressure 6 bar. Maximum system test pressure 10 bar. Working temperature range -10–40°C. Ambient temperature range -20–60°C. Medium water, saline solutions and glycol solutions. Maximum percentage of glycol 50%.

### Code 111001/3

Insulation for shut-off valves. For size valves Ø 25, Ø 32 (111001), Ø 40 (111003). Material closed cell expanded PE-X. Thickness 10 mm. Density inner part 30 kg/m<sup>3</sup>, outer part 80 kg/m<sup>3</sup>. Thermal conductivity (DIN 52612) at 0°C 0,038 W/(m·K), at 40°C 0,045 W/(m·K). Coefficient of resistance to water vapour (DIN 52615) > 1300. Working temperature range 0–100°C. Reaction to fire (DIN 4102) class B2.

### Code 111010

Flow rate integrated measuring sensor with Vortex effect. Composite material body. Fitted to be attached solely to 111 series shut-off valve. Maximum working pressure 6 bar. Working temperature range -10–60°C. Ambient temperature range -20–60°C. Medium water, glycol solutions and saline solutions. Maximum percentage of glycol 50%.

### Code 130010

Flow rate electronic measuring station to connect Vortex effect sensor. Complete with case, electric supply unit, control lever, measuring sensor with Vortex effect, connection cable, clip and lock. Rechargeable NiMH 9 V battery. Electric supply 230 V 50 Hz. Maximum power output of electric supply unit 6 W. Flow rate scale 300–1400 l/h. Accuracy of flow rate reading with Vortex sensor ±10%. Protection class IP 44.

We reserve the right to change our products and their relevant technical data, contained in this publication, at any time and without prior notice.