

Adjustable thermostatic mixing valve with knob with anti-scald safety function

5217 series



01145/21 EN

replaces 01145/07 GB



Function

In some domestic hot water distribution systems there is a need to protect more vulnerable individuals against scalding caused by hot water, such as, for example, in hospitals, nursing homes or schools.

This particular series of thermostatic mixing valves has been specifically designed for this type of applications, for user outlets and installation upstream from the drawing points.

These thermostatic mixing valves ensure high thermal performance. They are able to control the flow temperature of the mixed water supplied to the user accurately in case of variations in the inlet supply pressure or temperature, or in the drawn-off flow rate.

They are also equipped with an anti-scald safety function which immediately shuts off the flow of hot water in the event of a failure in the cold water supply.

(Certified to NF 079 doc. 8 - Device of class 12 (1/2") and class 20 (3/4"), RU type, user adjustable).



Product range

Code **521714** Adjustable thermostatic mixing valve with knob, anti-scald, complete with inlet strainers and check valves _____ DN 15 (1/2")
 Code **521713** Adjustable thermostatic mixing valve with knob, anti-scald, complete with inlet strainers and check valves _____ DN 15 (3/4")

Technical specifications

Materials

Body: brass EN 12165 CW617N, chrome plated
 Obturator: PSU
 Springs: stainless steel EN 10270-3 AISI (302)
 Seal elements: EPDM
 Cover: ABS

Performance

Adjustment range: 30–50 °C
 Accuracy: ±2 °C
 Max. working pressure (static): 10 bar
 Max. working pressure (dynamic): 5 bar
 Max. inlet temperature: 85 °C
 Recommended inlet temperature for the best system operation, avoiding limescale deposits (according to NF 079 doc. 8) ≤ 65 °C
 Max. inlet pressure ratio (H/C or C/H): 2:1
 Min. temperature difference between inlet hot water and outlet mixed water to ensure anti-scald performance: 15 °C
 Min. flow rate for stable operation: 4 l/min (DN 15)
 6 l/min (DN 20)
 Acoustic group: I
 Connections: 1/2" and 3/4" M (ISO 228-1) with union

Dimensions

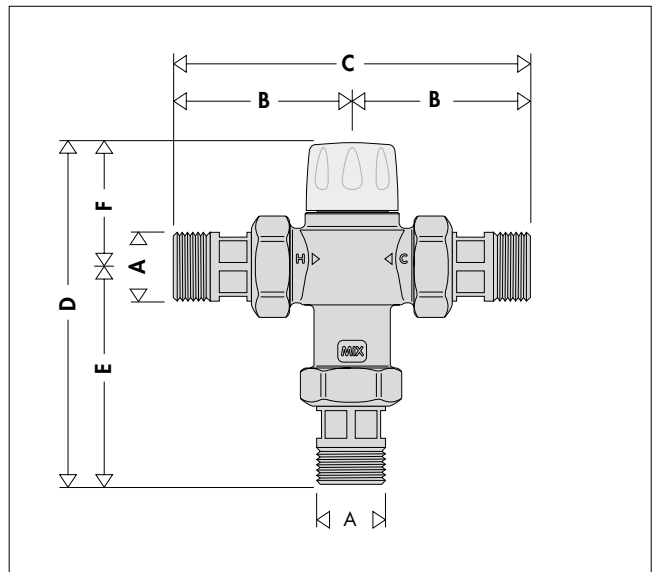

Code	DN	A	B	C	D	E	F	Mass (kg)
521714	DN 15	1/2"	62,5	125	126,5	81,5	45	0,58
521713	DN 20	3/4"	67	134	127	82	45	0,81

Legionella - scalding risk

In systems that produce hot water with storage for domestic purposes, in order to prevent the proliferation of dangerous Legionella bacteria, the hot water must be stored at a temperature of at least 60 °C. At this temperature it is certain that the growth of the bacteria will be totally inhibited. At this temperature, however, the water cannot be used directly.

As shown in the diagram and table provided, temperatures over 50 °C can cause burns very quickly.

For example, at 55 °C, partial burn occurs in about 30 seconds, whereas at 60 °C partial burn occurs in about 5 seconds.

On average, these times are halved for children and elderly people. It is therefore necessary to use a thermostatic mixing valve able to:

- reduce the temperature at the user outlet to a lower value than the storage temperature so it can be used by the domestic utility.
- keep the temperature at the user outlet constant as the inlet pressure and temperature conditions change.
- prevent the outlet water temperature from reaching values above 50 °C.
- have an anti-scald safety function in the event of an accidental shortage of inlet cold water.

Temperature - Exposure time

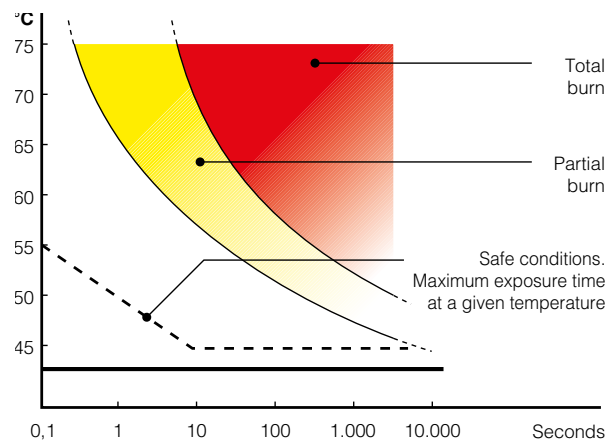

Thermal disinfection

The adjacent diagram shows the behaviour of *Legionella Pneumophila* bacteria as the temperature conditions of the water containing the bacteria vary.

To ensure correct thermal disinfection, it is necessary to go up to values of at least 60 °C.

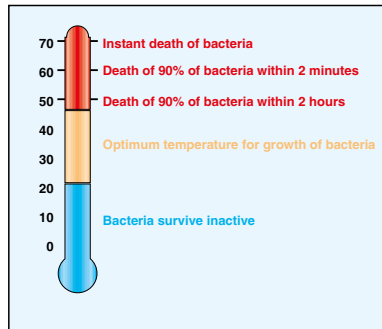

Exposure time to cause partial burns

Temperature	Adults	Children 0-5 years
70 °C	1 s	--
65 °C	2 s	0.5 s
60 °C	5 s	1 s
55 °C	30 s	10 s
50 °C	5 min	2.5 min

Operating principle

The thermostatic mixing valve mixes the hot and cold water at the inlet so as to maintain the mixed water constantly at the set temperature at the outlet. A thermostatic element (1) is fully immersed in the mixed water pipe. It contracts or expands, moving an obturator (2) which controls the passage of hot or cold water at the inlet. If the inlet temperature or pressure changes, the internal element automatically reacts to restore the set temperature at the outlet.

Construction details

Anti-scale materials

The materials used in constructing the mixing valve were selected to eliminate seizing due to limescale deposits. All functional parts have been made using a special anti-scale material with low friction coefficient, which ensures over time performance.

Anti-scald safety function

As a safety measure, in case of failure of the cold water supply at the inlet, the valve immediately shuts off the flow of the hot water. This prevents dangerous burns.

This performance is guaranteed if there is a minimum temperature difference between the inlet hot water and the outlet mixed water of 15 °C (performance in compliance with French standards NF 079 Doc 8).

Also in case of failure of the hot water supply, the valve shuts off the cold water port and thus the outlet mixed water to prevent dangerous thermal shocks.

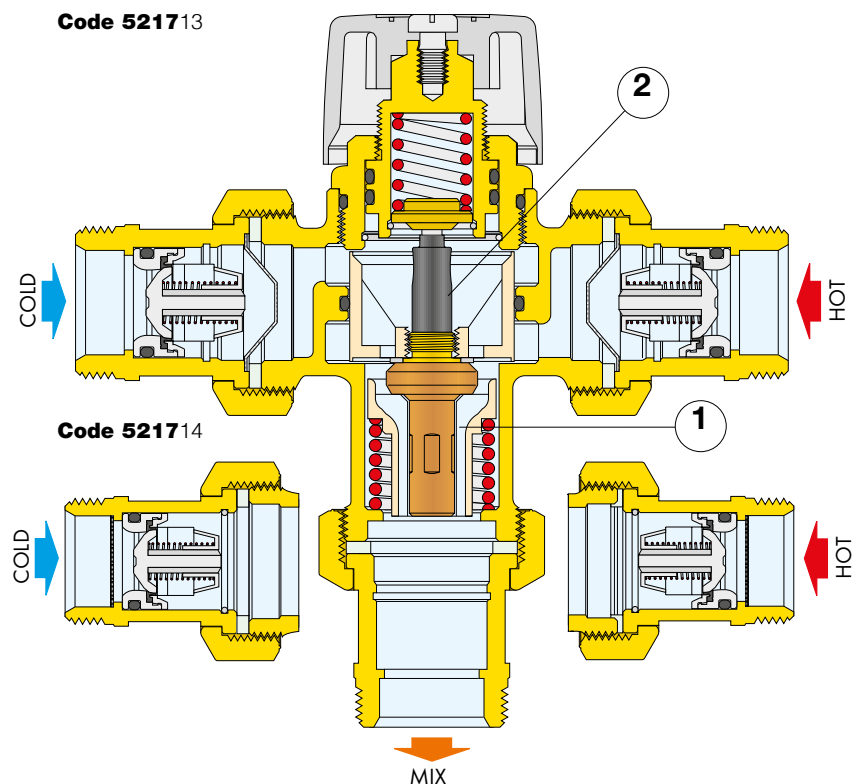

Hydraulic characteristics

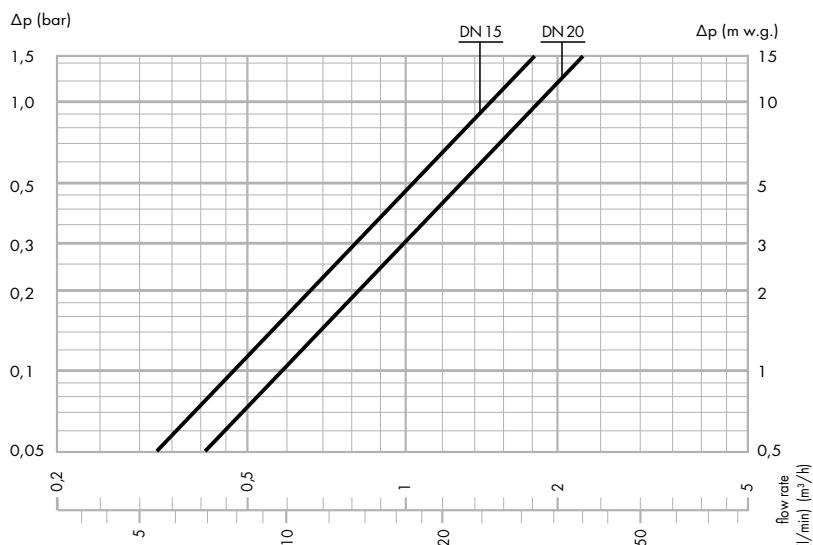

Code	DN	Ø	Kv (m³/h)
521714	DN 15	1/2"	1,5
521713	DN 20	3/4"	1,85

Utilisation

In view of its flow-rate characteristics, the Caleffi 5217 series thermostatic mixing valve can be used for application at the drawing point or for a limited number of users, for example a bathroom. For this reason, the flow rate passing through the mixing valve is generally the same passing through the end user outlet, for example the tap of the washbasin, shower, bidet, etc. To ensure optimal performance, it is necessary to ensure the mixing valve has a minimum flow rate of 4 l/min (DN 15) and 6 l/min (DN 20). The system must always be sized taking into account current legislation regarding the nominal flow rate for each user.

Public buildings, hospitals, kindergartens

In this type of application, the risk of scalding is extremely high because of the type of people using the hot water, like children, old people and invalids. In these installations, the two supply networks providing hot water from the boiler and cold water may have different origins and operate at different pressures. In the event of cold water supply failure, the mixing valve is able to shut off immediately the water outlet in order to prevent the risk of scalding.

Selecting the mixing valve size

Given the design flow rate, taking into account simultaneous use of the domestic appliances, the mixing valve size should be selected by checking the head loss on the provided graph. In this case, it is necessary to check the available pressure, the head loss in the system downstream of the mixing valve and the residual pressure to be guaranteed for user appliances.

Installation

Before installing the mixing valve, the connecting pipes should be flushed to remove any impurities that could impair performance.

We recommend always installing strainers of sufficient capacity at the inlet from the water main.

The 5217 series mixing valves are equipped with strainers at the hot and cold water inlets.

5217 series thermostatic tempering valves must be installed according to the diagrams shown in the instruction sheet or in this leaflet.

5217 series thermostatic mixing valves can be installed in any position, horizontally or vertically.

The following are indicated on the body of the mixing valve:

- hot water inlet, indicated by the letter "H" (Hot)
- cold water inlet, indicated by the letter "C" (Cold)
- mixed water outlet, indicated by the word "MIX".

Check valves

In systems with thermostatic mixing valves, check valves must be installed to prevent undesired backflow. 5217 series mixing valves are equipped with check valves at the hot and cold water inlets.

Thermal transients

During the transient, as a consequence of rapid changes in pressure, temperature or flow rate, the temperature increases with respect to the initial set point and this increase must be of limited duration to guarantee safety.

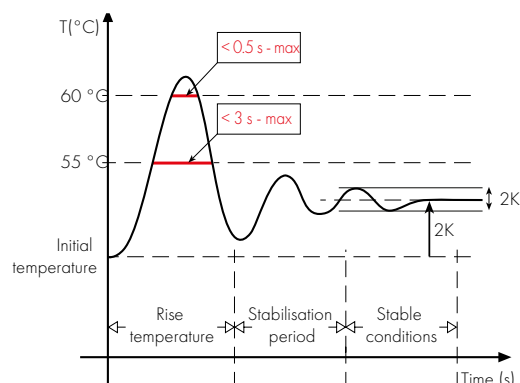

Commissioning

In view of the special applications of the thermostatic mixing valve, it must be commissioned in accordance with current regulations by qualified technicians, using appropriate temperature measurement equipment. We recommend using a digital temperature gauge for measuring the mixed water temperature.

Temperature regulation

The temperature is set at the desired value using the control knob. Given the specific use of this type of mixing valve, the following table lists the maximum tap water temperatures to prevent scalding.

Appliance	Tmax
Bidet	38 °C
Shower	41 °C
Washbasin	41 °C
Bath	44 °C

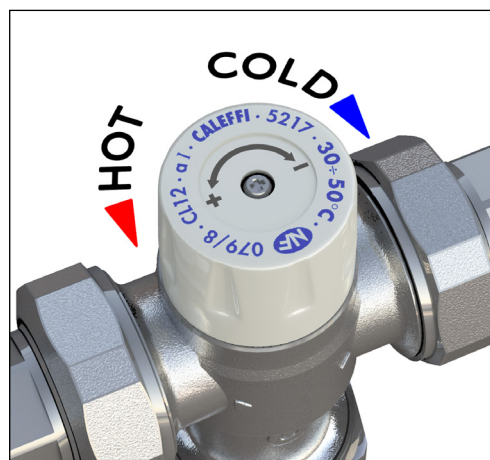

Application diagrams

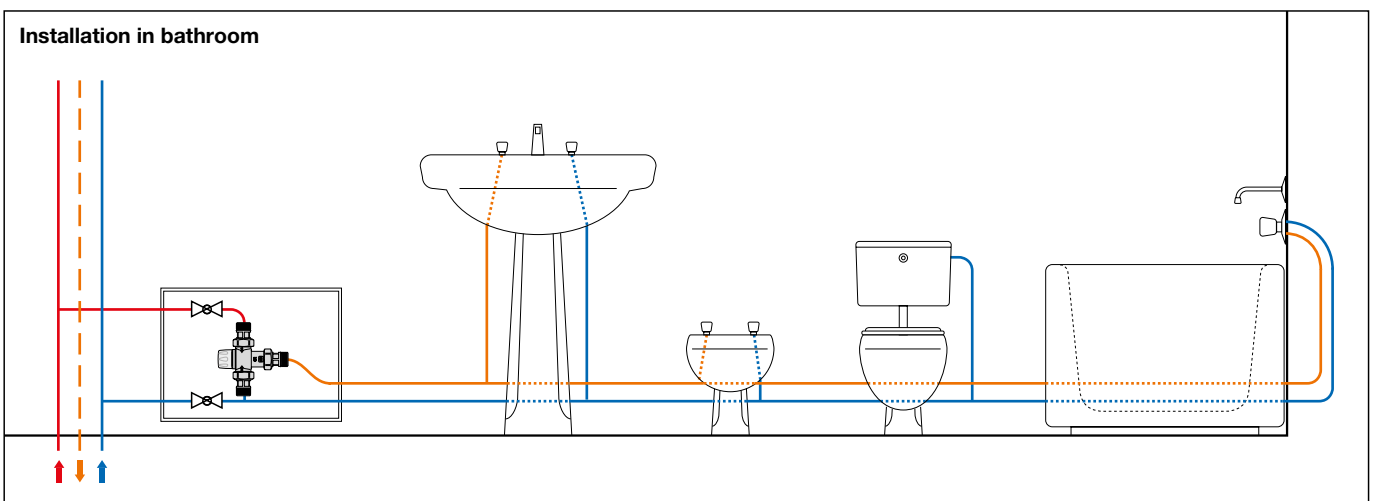
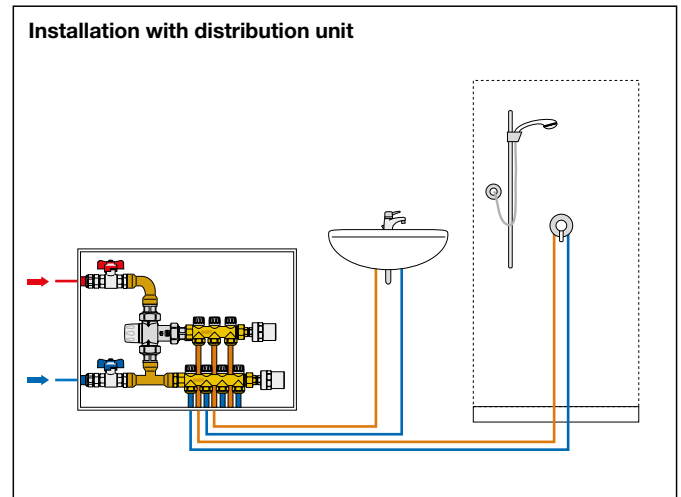
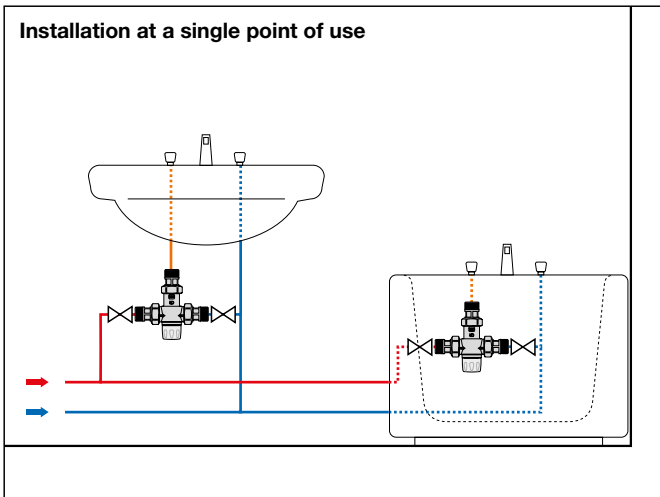

SPECIFICATION SUMMARY

5217 series

Adjustable thermostatic mixing valve with knob, with anti-scald safety function. Certified to standard NF 079 doc 8. Connections 1/2" (DN 15) and 3/4" (DN 20) M (ISO 228-1). Brass body. Chrome plated. PSU obturator. Stainless steel springs. EPDM seal elements. ABS cover. Maximum working temperature 85 °C. Adjustment range from 30 °C to 50 °C. Accuracy ± 2 °C. Maximum working pressure (static) 10 bar. Maximum working pressure (dynamic) 5 bar. Maximum inlet pressure ratio (H/C or C/H) 2:1. Complete with strainers and check valves on the inlet.

We reserve the right to make changes and improvements to our products and the related technical data in this publication, at any time and without prior notice. The website www.caleffi.com always has the most up-to-date version of the document, which should be used for technical verifications.