

Adjustable Thermostatic Mixing Valve for Solar Systems

© Copyright 2018 Caleffi

2521 Series

INSTALLATION AND COMMISSIONING MANUAL



ASSE 1017



Scan to view .



2521 Solar Mixing Valve

Installation Tip

Function

The thermostatic mixer is used in solar thermal systems producing domestic hot water. Its function is to maintain the temperature of the mixed water supplied to the user constant at the set value when there are variations in the supply conditions of the incoming hot and cold water. This particular series of mixing valves can function continuously at the high temperatures of incoming hot water from the solar storage tank. The valve has been specifically certified to ASSE 1017.

Product range

Series 2521 thermostatic mixing valve. Union thread NPT male connections, sizes 1/2", 3/4", 1"; union solder connection, size 1/2", 3/4", 1".

Technical Characteristics

- Materials: - Body: Low-lead brass (<0.25% Lead content), chrome plated
- Shutter: PSU
- Springs: Stainless steel
- Seals: EPDM
- Setting range: 85–150°F (30–65°C)
- Accuracy: ±3°F (±2°C)
- Max working pressure (static): 200 psi (14 Bar)
- Max working pressure (dynamic): 75 psi (5 bar)
- Min working pressure (dynamic): 3 psi (0.2 bar)
- Max hot water inlet temperature: 212°F (100°C)
- Maximum inlet pressure ratio (H/C or C/H): 2:1
- Minimum temperature difference between hot water inlet and mixed water outlet for optimum performance: 30°F (15°C)
- Min. flow rate to ensure stable temperature: 1.3 gpm (5 lpm)
- Certified to: ASSE 1017
- Lead Plumbing Law Compliance: (0.25% Max. weighted average lead content)
- Lead Plumbing Law Certified by ICC-ES, file MPG-1360.



SAFETY INSTRUCTION

This safety alert symbol will be used in this manual to draw attention to safety related instructions. When used, the safety alert symbol means **ATTENTION! BECOME ALERT! YOUR SAFETY IS INVOLVED! FAILURE TO FOLLOW THESE INSTRUCTIONS MAY RESULT IN A SAFETY HAZARD.**



WARNING: This product can expose you to chemicals including lead, which is known to the State of California to cause cancer and birth defects or other reproductive harm. For more information go to www.P65Warnings.ca.gov.



CAUTION: All work must be performed by qualified personnel trained in the proper application, installation, and maintenance of systems in accordance with all applicable codes and ordinances.



CAUTION: If the thermostatic mixer is not installed, commissioned and maintained properly, according to the instructions contained in this manual, it may not operate correctly and may endanger the user.



CAUTION: Make sure that all the connecting pipework is water tight.



CAUTION: When making the water connections, make sure that the mixer connecting pipework is not mechanically over-stressed. Over time this could cause breakages, with consequent water losses which, in turn, could cause harm to property and/or people.



CAUTION: Water temperatures higher than 100°F can be dangerous. During the installation, commissioning and maintenance of the thermostatic mixer, take the necessary precautions to ensure that such temperatures do not endanger people.



CAUTION: In the case of highly aggressive water, arrangements must be made to treat the water before it enters the thermostatic mixer, in accordance with current legislation. Otherwise the mixer may be damaged and will not operate correctly.



CAUTION: If installing in an ASSE 1017 application, check valves shall be used.

Leave this manual for the user.

Operating Principle

The controlling element of the solar thermostatic mixing valve is a temperature sensor that is fully immersed in the mixed water outlet passage. As it expands or contracts, the sensor continuously establishes the correct proportion of hot and cold water entering the valve. The flow is regulated by a piston sliding in a cylinder between the hot and cold water passages.

Even when there are pressure drops due to the drawing off of hot or cold water for other uses or variations in the incoming temperature, the mixer automatically regulates the water flow to obtain the required temperature.

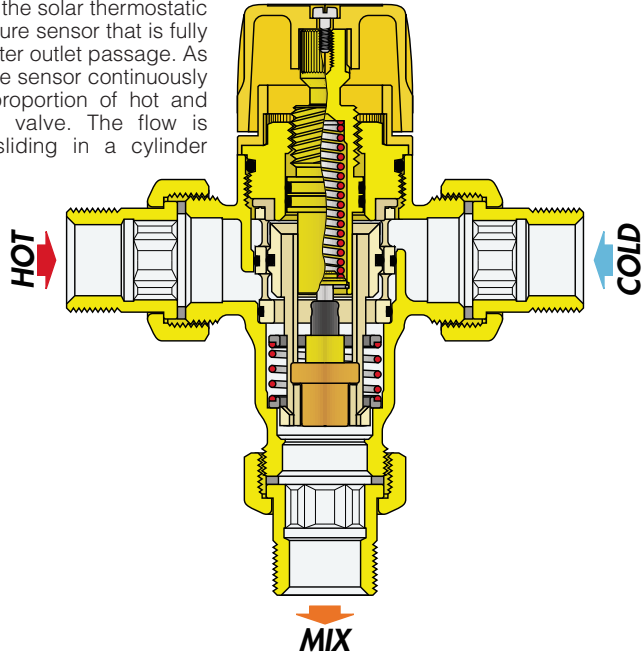

Flow curves

$C_v = 3.0$
 $K_v = 2.6$

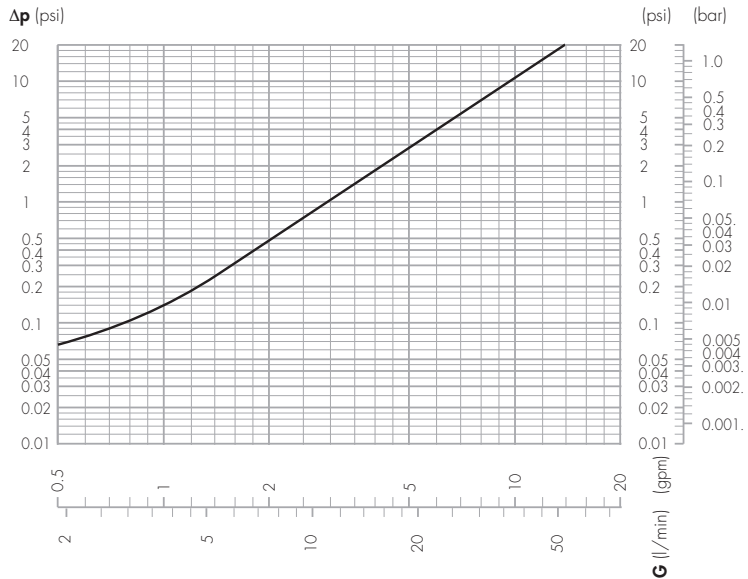

Exploded diagram

- 1 *Regulating knob*
- 2 *Head fixing screw*
- 3 *Regulating spindle*
- 4 *"O" Ring seal*
- 5 *Upper shutter seat*
- 6 *Thermostatic element*
- 7 *Inner shutter*
- 8 *"O" Ring*
- 9 *Outer shutter*
- 10 *"O" Ring*
- 11 *"O" Ring*
- 12 *Spring cover*
- 13 *Spring*
- 14 *Valve body*
- 15 *Union nut*
- 16 *Gasket*
- 17 *Tail piece body*

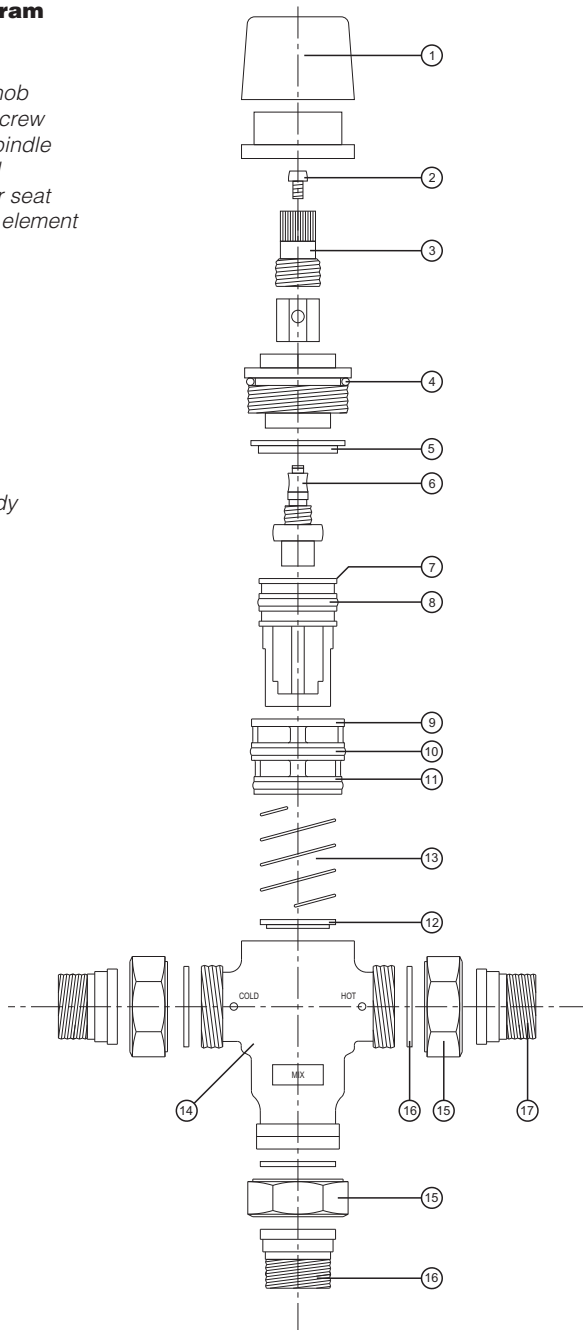

Use

 Thermostatic mixing valves are typically installed at the outlet of hot water storage tanks in solar systems to ensure constant temperature of the mixed water supplied to the end user. Because of their flow characteristics, the valves can be installed to control the temperature for both single point of use and for point of distribution. In order to guarantee the delivery of mixed water at the set temperature, the 2521 series thermostatic mixing valves must have a minimum flow rate of 1.3 gpm.

Installation

Before installing a Caleffi 2521 series mixing valve, the system must be inspected to ensure that its operating conditions are within the range of the mixer, checking, for example, the supply temperature, supply pressure, etc.

 Systems where the Caleffi 2521 series mixing valve is to be fitted must be drained and cleaned out to remove any dirt or debris which may have accumulated during installation. Failure to remove dirt or debris may affect performance and the manufacturer's product guarantee. The installation of filters of appropriate capacity at the inlet of the water from main supply is always advisable. In areas which are subject to highly aggressive water, arrangements must be made to treat the water before it enters the valve.

Caleffi 2521 series mixing valve must be installed in accordance with the diagrams in this manual, taking into account all current applicable standards.

Caleffi 2521 series mixing valve can be installed in any position, either vertical or horizontal.

The following are shown on the valve body:

- Hot water inlet, color red and marked "HOT".
- Cold water inlet, color blue and marked "COLD".
- Mixed water outlet, marked "MIX".

It is essential that access to the valve is totally unobstructed for any maintenance which may be required to the valve or connections. The pipework from/to the valve must not be used to support the weight of the valve itself.

Application Diagrams

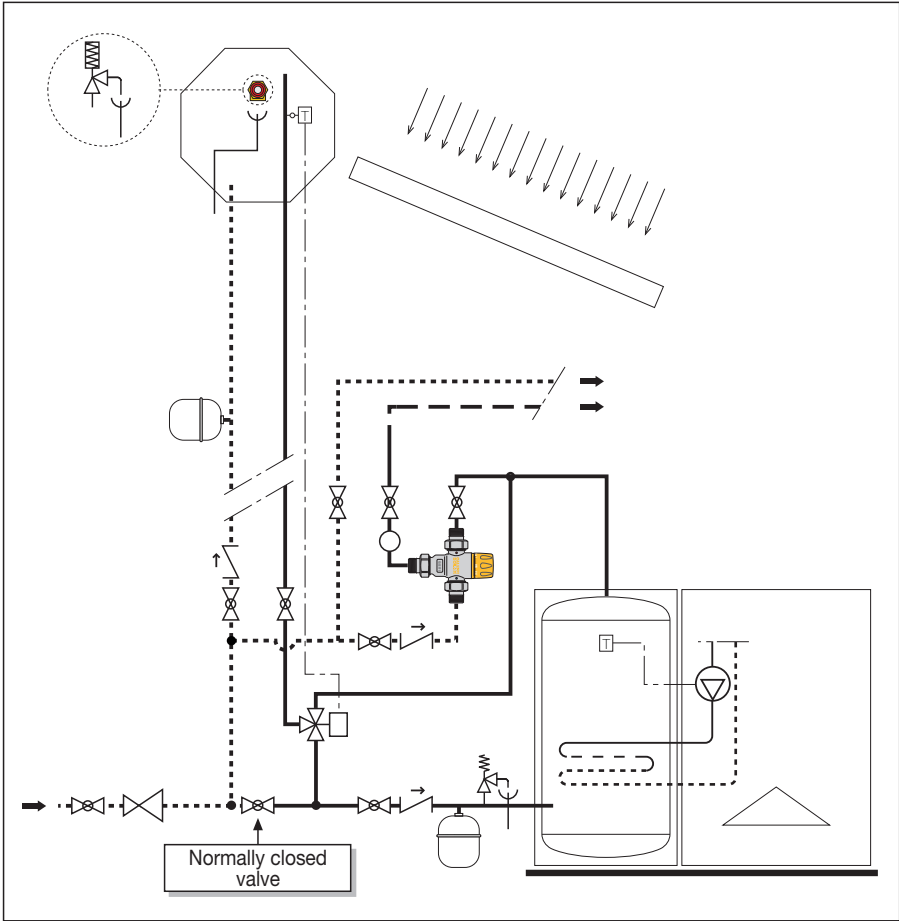
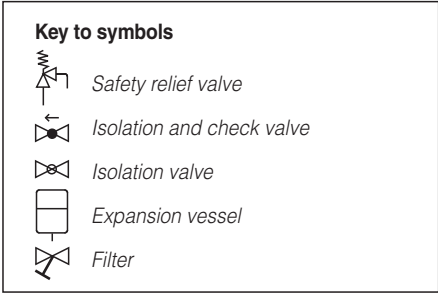
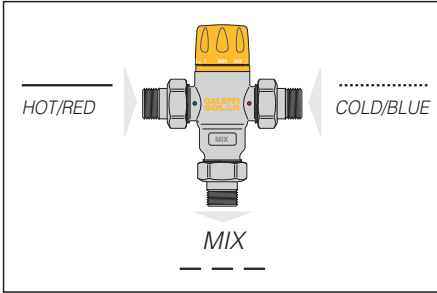

Commissioning

After installation, the valve must be tested and commissioned in accordance with the instructions given below, taking into account current applicable standards.

- 1) Ensure that the system is clean and free from any dirt or debris before commissioning the thermostatic mixer.
- 2) It is recommended that the temperature is set using a suitable calibrated digital thermometer. The valve must be commissioned by measuring the temperature of the mixed water emerging at the point of use.
- 3) The maximum outlet temperature from the valve must be set taking account of the fluctuations due to simultaneous use. It is essential for these conditions to be stabilised before commissioning.
- 4) Adjust the temperature using the adjusting knob on the valve. For safety reasons, it is advisable to limit the maximum mixed water temperature to 120°F in domestic hot water systems.

Setting the temperature

The temperature is set to the required value by means of the adjusting knob with the graduated scale on the top of the valve.

| Pos. | Min | 1 | 2 | 3 | 4 | 5 | 6 | 7 | Max |
|--------|-----|----|-----|-----|-----|-----|-----|-----|-----|
| T (°F) | 81 | 90 | 100 | 111 | 120 | 127 | 136 | 145 | 152 |
| T (°C) | 27 | 32 | 38 | 44 | 49 | 53 | 58 | 63 | 67 |

with: $T_{HOT} = 155^{\circ}F (68^{\circ}C)$ · $T_{COLD} = 55^{\circ}F (13^{\circ}C)$ · $P = 43 \text{ psi (3 bar)}$

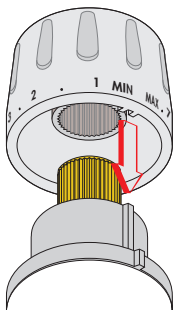

Preset locking

Position the handle to the number required. Unscrew the head screw, pull off the handle and reposition it so that the handle fits into the internal slot of the knob. Tighten the head screw.

Maintenance

In service tests should be carried out regularly to monitor the mixer performance, as deterioration of performance could indicate that the valve and/or the system require maintenance. If, during these tests, the temperature of the mixed water has changed significantly in comparison with the previous test, the details given in the installation and commissioning sections should be checked and maintenance carried out.

The following aspects should be checked regularly to ensure that the optimum performance levels of the valve are maintained. Every 12 months at least, or more often if necessary.

- 1) Check and clean the system filters.
- 2) Verify that any check valves positioned upstream of the Caleffi valve are operating correctly, without problems caused by impurities.
- 3) The Caleffi valve should not be dismantled. Limescale can be removed from internal components by immersion in a suitable de-scaling fluid.
- 4) When the components which can be maintained have been checked, commissioning should be carried out again.

Troubleshooting

Under normal operating conditions the Caleffi 2521 series mixing valve will provide a very high level of performance. However, in some circumstances, where our maintenance plan is not followed, the following problems may arise.

| Symptom | Cause | Corrective action |
|--------------------------------------|---|--|
| Fluctuating mixed water temperature | <ul style="list-style-type: none">a) Erratic supply temperatures at the inlets of the valve.b) Starvation of the water supplies at the inlets of the valve.c) Incorrect commissioning of the valve. | <ul style="list-style-type: none">· Restore inlet conditions within the limits of the valve. |
| Erratic flow of water from the valve | <ul style="list-style-type: none">a) Insufficient water supplies.b) Fluctuations in supply pressures/temperatures.c) Adverse effect created by other draw off points on the system. | <ul style="list-style-type: none">· Stabilize inlet supply conditions. |
| No flow of water from the valve | <ul style="list-style-type: none">a) In-line filters blocked.b) Insufficient supply pressures.c) Debris obstructing valve operation. | <ul style="list-style-type: none">· Clean filters.· Restore inlet supplies.· Clean debris or scale from valve. |

Leave this manual for the user.



Caleffi North America, Inc.
3883 West Milwaukee Road
Milwaukee, WI 53208
T: 414.238.2360 F: 414.238.2366