

Outside compensated temperature regulating unit

174 series



BSI EN ISO 9001:2000
Cert. n° FM 21654



UNI EN ISO 9001:2000
Cert. n° 0003

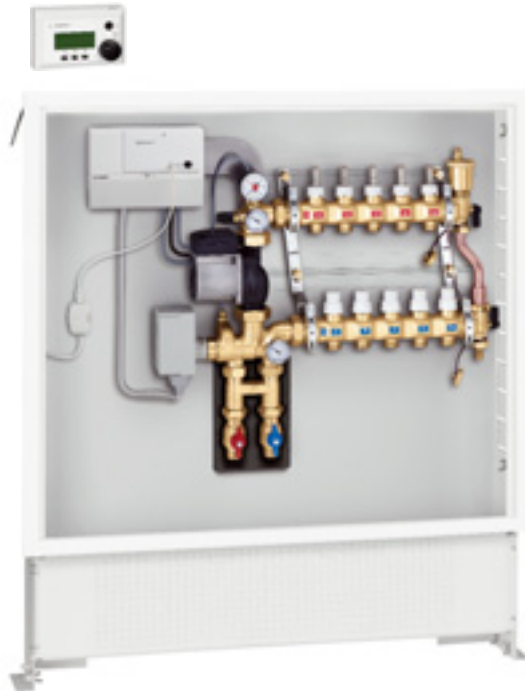

Function

The temperature regulating unit is made to be used in radiant panel systems in combination with distribution manifolds.

The outside compensated temperature regulating unit, complete with temperature digital regulator, controls the temperature of the medium sent to the panels, with a compensation depending on the outside and inside temperature and the actual thermal load.

In this particular series, the temperature is regulated by a dedicated hydraulic unit equipped with a specific motorised three-way valve.

It is supplied with a removable differential by-pass kit for the primary circuit. This accessory is essential when there is a primary circuit circulation pump and the radiator circuits or fan coils are controlled by thermostatic or thermo-electric valves.

In case of connection with a Sepcoll or an hydraulic separator without primary pump, the kit can be removed and the hydraulic unit is connected directly.

Patent application No. MI2006A001935.



Reference Documentation

- Tech. brochure 01144 Pre-assembled distribution manifolds for radiant panel systems 668...S1 series

Product range

Code **1745.1** Outside compensated temperature regulating unit, with UPS 25-60 pump
Code **1745.3** Outside compensated temperature regulating unit, with UPS 25-80 pump

Technical specifications

Materials

Regulating unit with motorised three-way valve

Body: brass EN 1982 CB753S
Headwork: brass EN 12164 CW614N
Obturator: stainless steel
Seals: EPDM

Flow adapter unit

Body: brass EN 1982 CB753S

Primary circuit by-pass kit

Body: brass EN 1982 CB753S
By-pass valve: POM
Spring: stainless steel

Shut-off valves

Body: brass EN 12165 CW617N
Ball: brass EN 12164 CW614N, chrome plated

Performance

Medium: water, glycol solutions
Max. percentage of glycol: 30%
Control temperature range: 20–90°C
Primary inlet temperature range: 5–100°C
Max. working pressure: 10 bar
Panel manifold differential by-pass setting: 25 kPa (2.500 mm w.g.)
Primary circuit differential by-pass setting: 10 kPa (1.000 mm w.g.)
Temperature gauge scale: 0–80°C
Pressure gauge scale: 0–10 bar
Connections: - primary circuit: 3/4" M
- to regulating unit: 1" F with nut
- panel circuit outlets: 3/4" M - Ø 18 mm
- outlet centre distance: 50 mm

Panel circuit differential by-pass graph

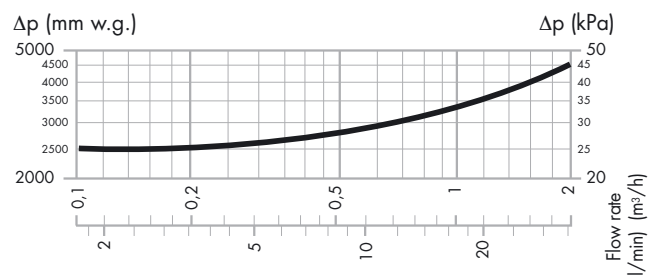

Digital controller

Three-point type
 Electric supply: 230 V - 50 Hz
 Power consumption: 5,5 VA
 Protection class: IP 40

Actuator

Three-point type
 Electric supply: 230 V - 50 Hz
 Operating time: 50 s (rotation 120°)
 Power consumption: 8 VA
 Auxiliary microswitch contact rating: 0,8 A
 Protection class: IP 44
 Max. ambient temperature: 55°C
 Protective cover: self-extinguishing VO

Flow/return temperature probes

NTC type
 Working range: -20–100°C
 Two-wire cable

Safety thermostat

Factory set: 55°C ±3°C
 Protection class: IP 55
 Contact rating: 10 A / 240 V

Pump

Three-speed pump: model UPS 25-60/UPS 25-80
 Material: Body: cast iron GG 15/20
 Electric supply: 230 V - 50 Hz
 Max. ambient humidity: 95%
 Max. ambient temperature: 80°C
 Protection class: IP 44
 Pump centre distance: 130 mm
 Pump connections: 1 1/2" with nut

Head available at the regulating unit connections

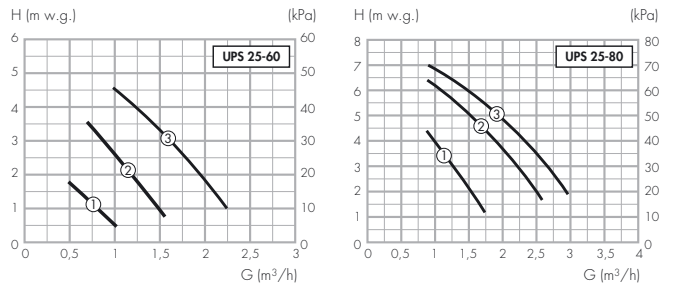

Power consumption

Speed	I (A)	P (W)	n (rpm)
3	0,40	90	1800
2	0,30	65	1100
1	0,20	45	700

Speed	I (A)	P (W)	n (rpm)
3	1,04	245	2450
2	0,92	210	1500
1	0,63	140	1000

Insulation

Material: closed cell expanded PE-X
 Thickness: 15 mm
 Density: - inner part: 30 kg/m³
 - outer part: 50 kg/m³
 Thermal conductivity (DIN 52612): 0°C: 0,038 W/(m·K)
 40°C: 0,045 W/(m·K)
 Coefficient of resistance to the diffusion of water vapour (DIN 52615): >1300
 Working temperature range: 0–100°C
 Reaction to fire (DIN 4102): class B2

Dimensions

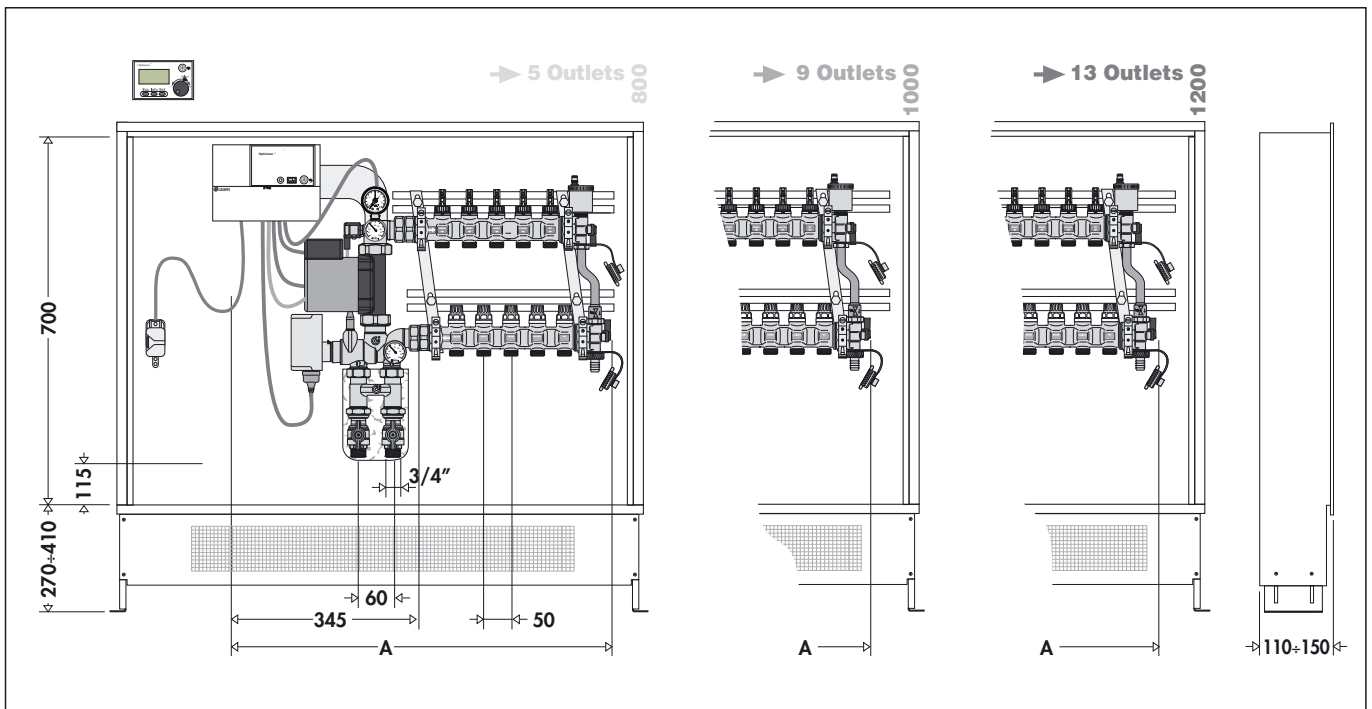

code	with pump ups 25-60	1745E1	1745F1	1745G1	1745H1	1745I1	1745L1	1745M1	1745N1	1745O1
	with pump ups 25-80	-	-	-	-	-	1745L3	1745M3	1745N3	1745O3
	Panel outlets	5	6	7	8	9	10	11	12	13
	A	695	745	795	845	915	965	1015	1065	1115

Characteristic components

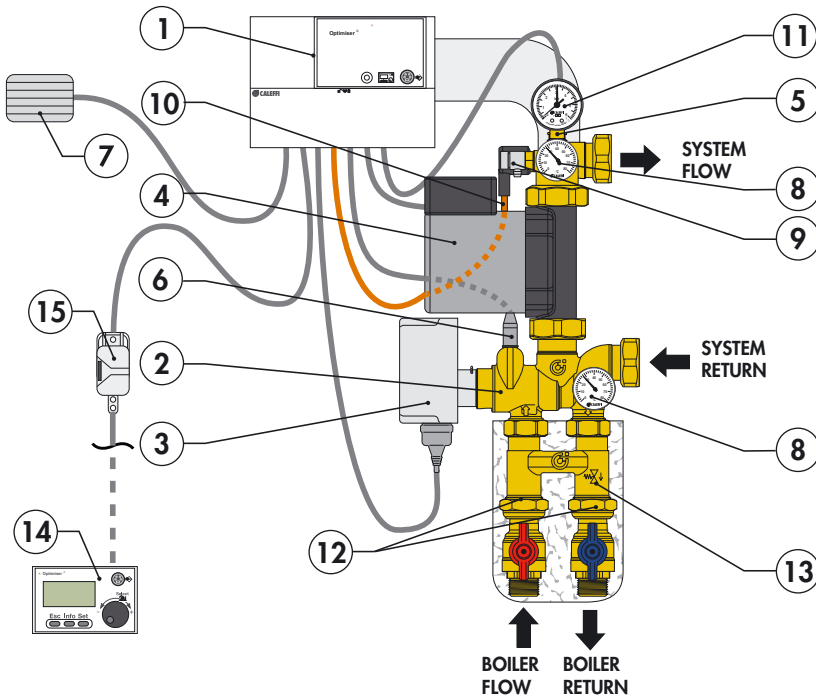

Flow manifold equipped with flow meters and balancing valves.

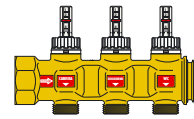

Return manifold equipped with shut-off valves.

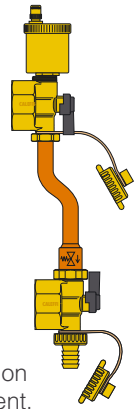
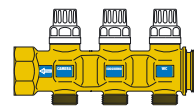

End fittings with multi-position ball valves, automatic air vent, **differential by-pass kit** and fill/drain hose connection.

- 1 Digital temperature controller Optimiser
- 2 Three-way mixing valve
- 3 Three-point actuator
- 4 Three-speed circulation pump UPS 25-60
Three-speed circulation pump UPS 25-80
- 5 Flow temperature probe
- 6 Return temperature probe
- 7 Outside temperature probe
- 8 Flow and return temperature gauges with pocket

- 9 Adjustable drain cock
- 10 Safety thermostat
- 11 Pressure gauge
- 12 Primary circuit shut-off valves
- 13 Primary circuit differential by-pass kit
- 14 Remote control and room probe thermostat
- 15 Interface wire connection

Hydraulic diagram

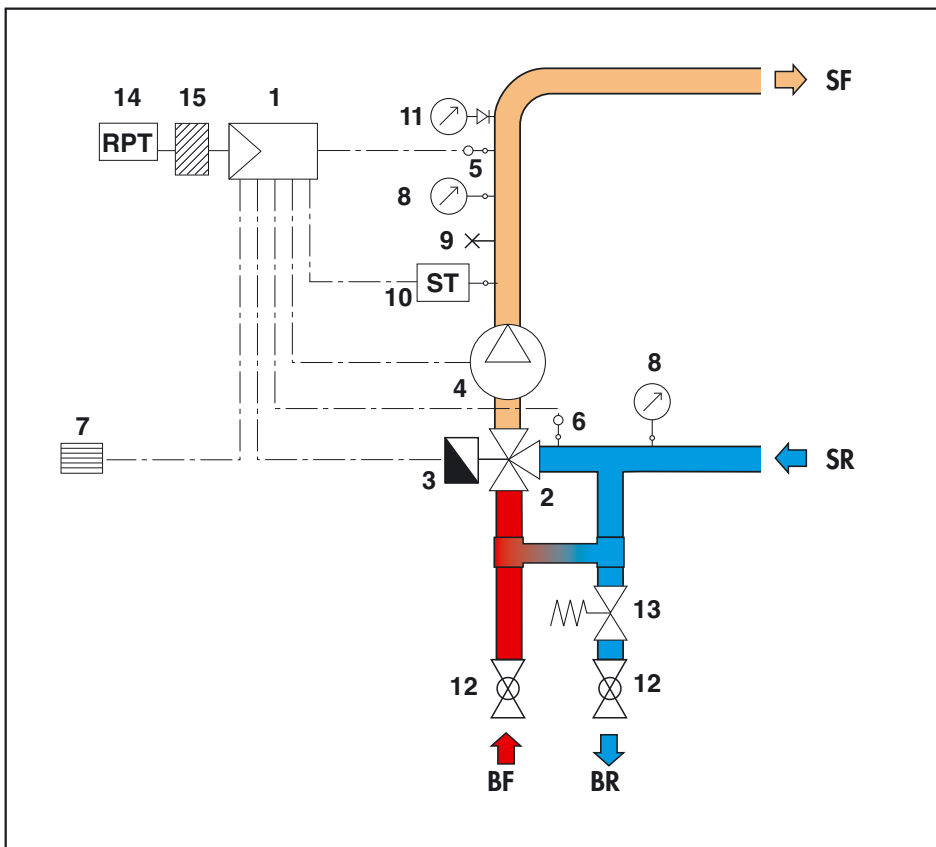

- Digital controller Optimiser
- Adjustable drain cock
- Temperature gauge
- Temperature probe
- Room probe thermostat
- Safety thermostat
- Ball shut-off valve
- Motorised three-way valve
- Pressure gauge
- Pump
- Differential by-pass
- Interface wire connection
- Outside temperature probe

Operating principle

The medium temperature is regulated by a three-way mixing valve with a sector obturator comprehensive of an actuator managed by a specific digital controller.

The controller receives the signal from four probes, flow probe on the mixing valve outlet, probe on the panel circuit return, outside probe and room probe. It controls the valve movement.

The flow in the valve is regulated by a shaped obturator (1) that, by turning, closes or opens the hot water flow ports (2) and the water returning ports from the circuit (3) to adjust the desired flow temperature.

Even if the secondary circuit thermal load or the inlet temperature from the boiler change, the mixing valve automatically adjusts the flow rates until it obtains the optimal flow temperature.

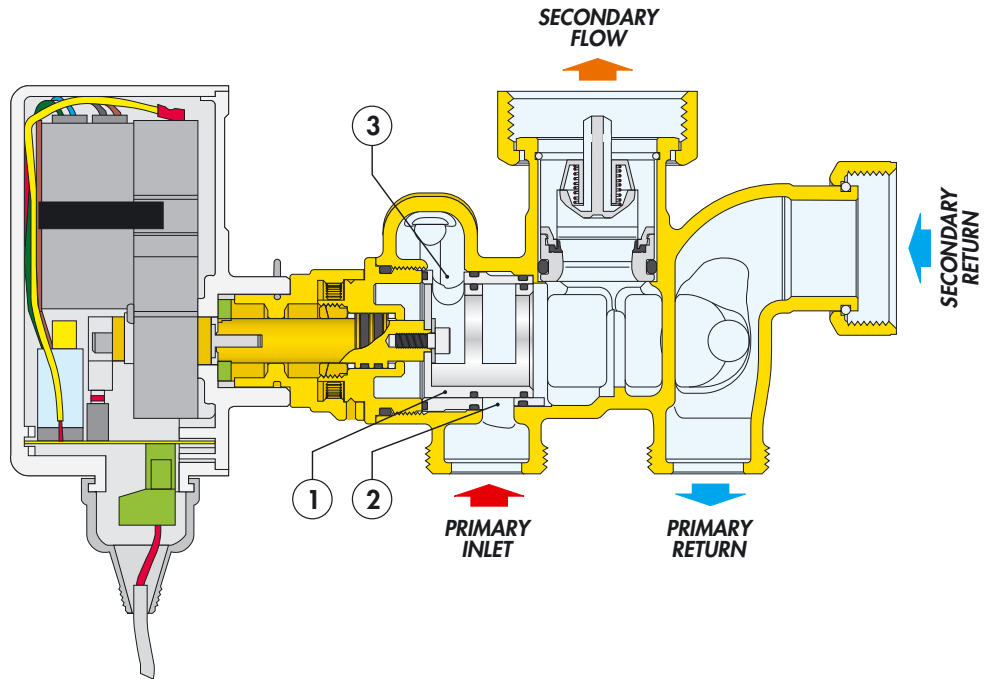

Construction details

Regulating unit body

The valve body, containing the thermal regulating device, is made out of a single casting with connections to the primary and secondary circuits. A specific internal channel carries the system return medium to the regulating valve, making it possible for the unit to be smaller in size and easy to connect.

Reduced head losses

The three-way mixing valve is equipped with a special obturator acting on calibrated water orifices. This ensures a high flow rate and a reduced size, while maintaining accurate temperature control, with no swinging due to sudden changes in thermal load.

Electrical connections

The actuator is electrically connected through an external plug-socket system with a protective rubber cap. This system does not require opening the lid to connect the cables.

In this way, replacing the actuator (should this ever be necessary) is particularly easy to do.

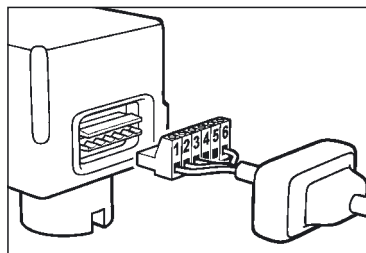

Auxiliary microswitch

The actuator is equipped with an auxiliary microswitch that can be used to switch on the generator.

Mixing valve fully closed: contact OFF.

Start opening mixing valve: contact ON.

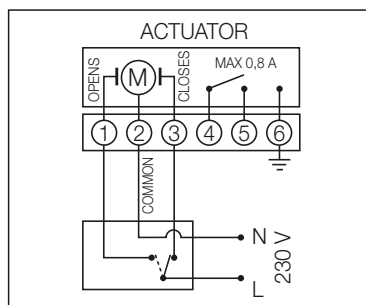

Manual opening

By removing the actuator, the valve can be opened-closed manually by using a screwdriver.

Regulating way - primary inlet

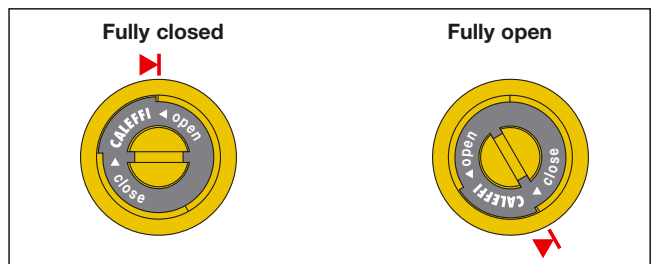

Flow unit

The flow unit is made out of a single casting with the necessary ports to connect with the functional components such as the safety thermostat, temperature gauge, pressure gauge, drain cock and flow temperature probe.

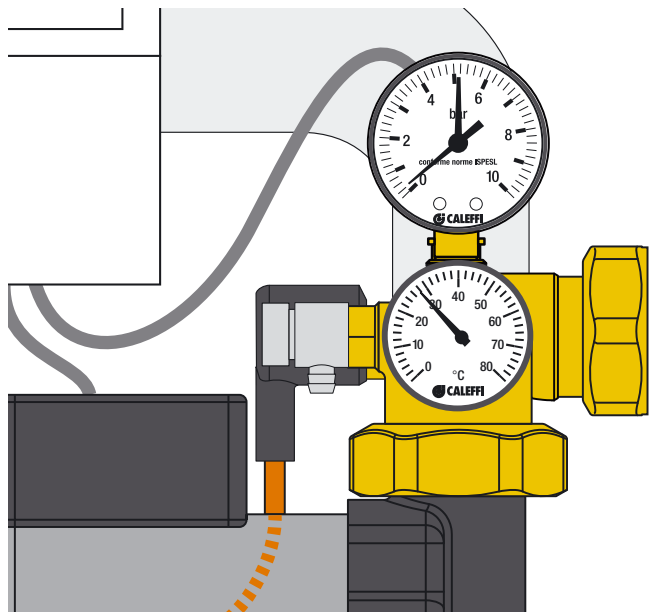

Differential by-pass kit for primary circuit

Operation

The differential by-pass kit for the primary circuit enables controlling the flow supplied to the heating elements connected before the outlet to the panel circuit regulating unit.

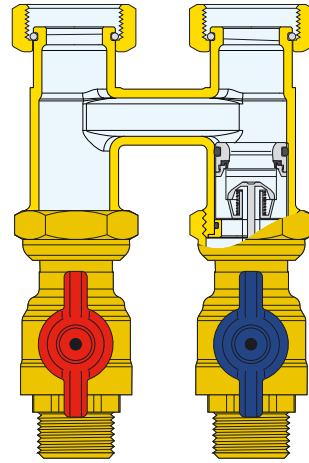

Removable kit

In case of an hydraulic circuit connected to a Sepcoll or to an hydraulic separator without primary pump, the kit can be removed and the hydraulic unit is connected directly. The circuit shut-off valves, equipped with nut connection, can be removed easily and used directly on the unit.

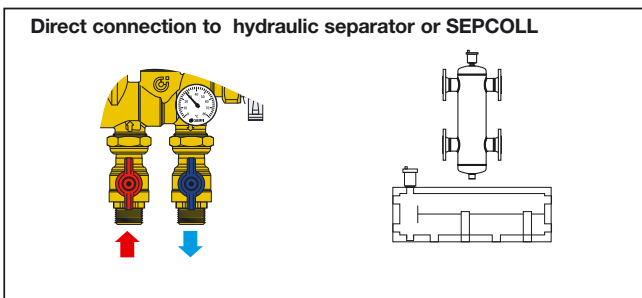
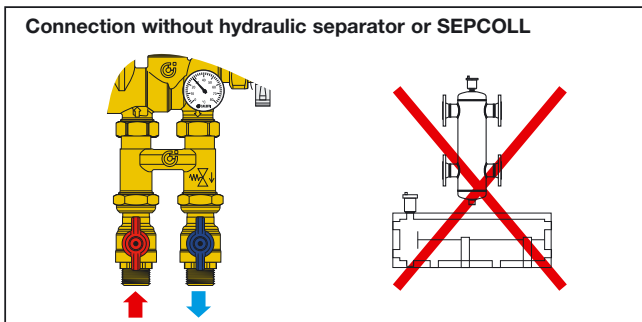

Differential valve

The differential valve is used to control the head in the primary distribution circuit. It aids the flow circulation towards the heating elements and limits overpressure if there are thermostatic or thermo-electric valves.

The differential valve has a fixed setting that cannot be changed. It is preset to 10 kPa, mean value for the loss of head in the primary circuit.

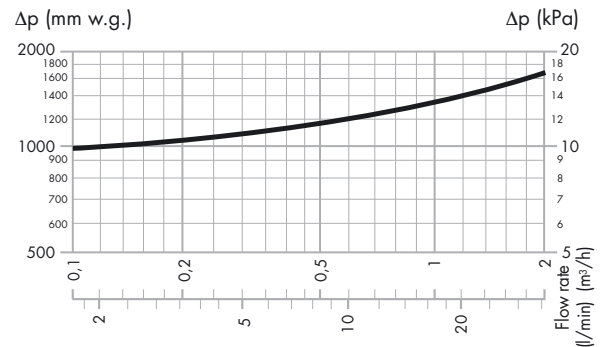

Primary circuit by-pass kit

The by-pass kit permits hydraulic separation between the primary and secondary circuits. This hydraulic separation optimizes the operation of the secondary circuit at the panels thus preventing the influence on the secondary circuit by any primary circuit flow rate variation. In this case, the flow rate through the respective circuits depends solely on the pump flow rate characteristics, preventing reciprocal influence due to their coupling in series. Two possible conditions of hydraulic balance are described here.

The component is typically sized in order to have the following working rate:

$$G_{\text{primary}} = G_{\text{secondary}} \text{ (inlet to the mixing valve)} + G_{\text{heating elements}}$$

G_{primary} maximum recommended: 1,5 m³/h

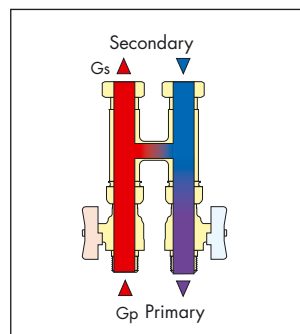

$G_{\text{primary}} > G_{\text{secondary}}$

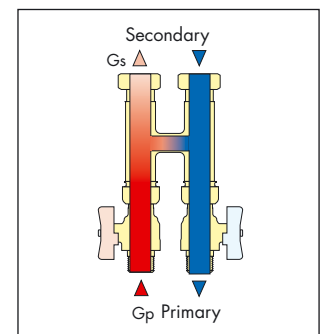

$G_{\text{primary}} < G_{\text{secondary}}$

Temperature controller

Remote control and room probe thermostat

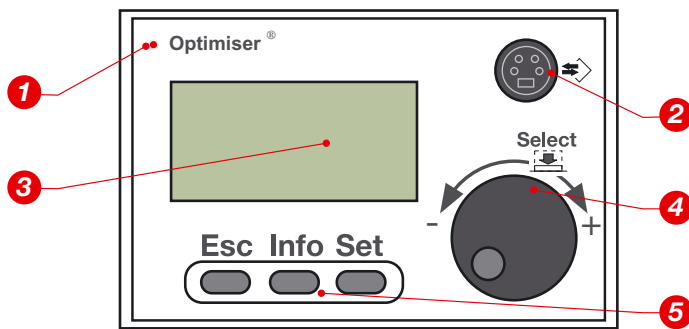

Description of controls

- The LED gives information on the status by means of a multicoloured diode; the statuses it indicates are as follows:
 - **flashing green:** controller initialisation
 - **fixed green:** controller operating
 - **flashing green/red:** controller operating with probe error
 - **flashing red:** controller verification loop
 - **prolonged red:** controller error
- The mini-DIN connector, on the front of the panel, makes it possible to view all the parameters managed by the control. A Sub D 9-pole mini-DIN data transmission cable is used for the connection to a PC. The cable and specific transmission program are available as optionals.

- The display shows the text in a clear way, giving all the information and menu points. All the values displayed are continuously refreshed. The monitor light switches on automatically when a function is selected. If no other commands are given in 4 minutes, the monitor goes back to the standard page and the light switches off.
- The Select knob can be turned to the right (+) or left (-) to go to the different menu, function or value editing fields. Press the knob to select any of the menu points.

Room temperature management

The remote control can be used to change the room temperature, either increasing it or decreasing it in relation to a standard reference value. The change (± 5 K) is shown in the lines on the display, with increments of 0,5 K in relation to the reference values: comfort 20°C; set-back correction 18°C. The actual room temperature is shown on the fourth line on the display.

5. Function keys:

- Esc** - Changes the display of the selected menu point and goes back to the previous menu level.
- The changed data are not accepted and not recorded.
- Info** - Displays brief information about the current menu point.
- Set** - The change that has been made is recorded.

Remote control base with room probe

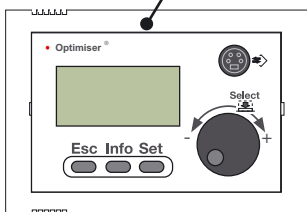

Interface wiring box

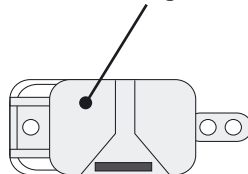

Transmission interface

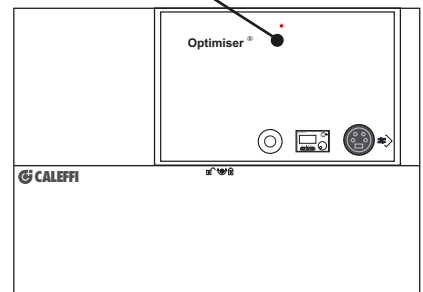

Installation of the control on board the controller

The control front panel can also be installed on board the controller. In this case, the wiring box and the base containing the room probe are no longer needed; the controller is no longer able to manage the room probe.

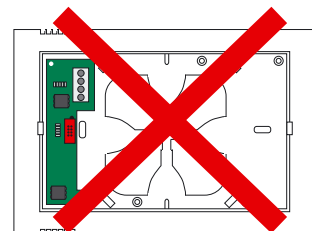
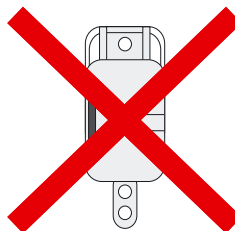
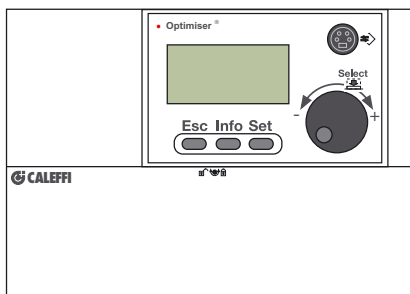

Immediate comfort function

This makes it possible to change the comfort without changing the controller set parameters.

The second line of the display shows the standard correction value - 0 of the characteristic curve. This value can be increased to + 5 or reduced to - 5 by turning the knob to the right or to the left respectively. Each single change corresponds to a 5% shift in the characteristic curve. Example, referred to factory configuration: flow temperature-heating start-up $T = 20^{\circ}\text{C}$ and flow T at outside min. temp. = 40°C corresponds to a temperature range ΔT of 20 K (100%). The adjustment of the correction is "+1"; this means that the temperature of the mixing valve circuit 1 is raised by 1 K (5% of ΔT), thus the flow temperature will be 41°C .

Terminal board

Electrical connections

L	Live
N	Neutral
La	Mixing valve relay contact
a1	Mixing valve opening contact
a2	Mixing valve closing contact
N	Neutral output for mixing valve and pump
b0	Pump relay contact
b1	Pump contact

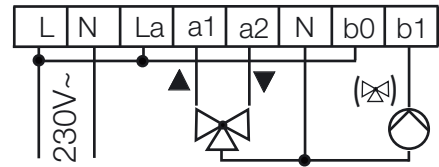

Probe connections

Terminal board X

X1	Outside probe
X2	Common outside and room probes
X3	Room probe
X4	Flow probe
X5	Common flow and return probes
X6	Return probe

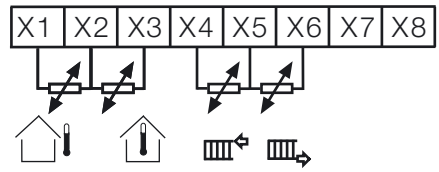

Activating the internal battery

The protective tab must be removed from the battery before setting the operating data.

Probe resistance table

°C	Ω	°C	Ω	°C	Ω	°C	Ω	°C	Ω	°C	Ω	°C	Ω
-20	14616	-2	6164	+16	2852	+34	1430	+52	767	+70	434	+88	260
-18	13211	±0	5634	+18	2632	+36	1331	+54	718	+72	409	+90	246
-16	11958	+2	5155	+20	2431	+38	1239	+56	673	+74	386	+92	233
-14	10839	+4	4721	+22	2247	+40	1154	+58	631	+76	364	+94	221
-12	9838	+6	4329	+24	2079	+42	1076	+60	592	+78	343	+96	210
-10	8941	+8	3974	+26	1925	+44	1004	+62	556	+80	324	+98	199
-8	8132	+10	3652	+28	1785	+46	938	+64	522	+82	306	+100	189
-6	7405	+12	3360	+30	1657	+48	876	+66	491	+84	290		
-4	6752	+14	3094	+32	1539	+50	819	+68	462	+86	274		

Remote control and room probe thermostat



Room probe thermostat resistance table

°C	Ω	°C	Ω
18	15720	21	14370
19	15260	22	13940
20	14800	23	13520

The remote control base must be positioned horizontally, following the usual installation instructions for a normal room probe thermostat.
If this is not possible, the room probe thermostat function must be disabled by positioning a jumper on terminal board X, contact x2=x3.
The controller automatically positions on the **immediate comfort function**.

Controller - remote control connection

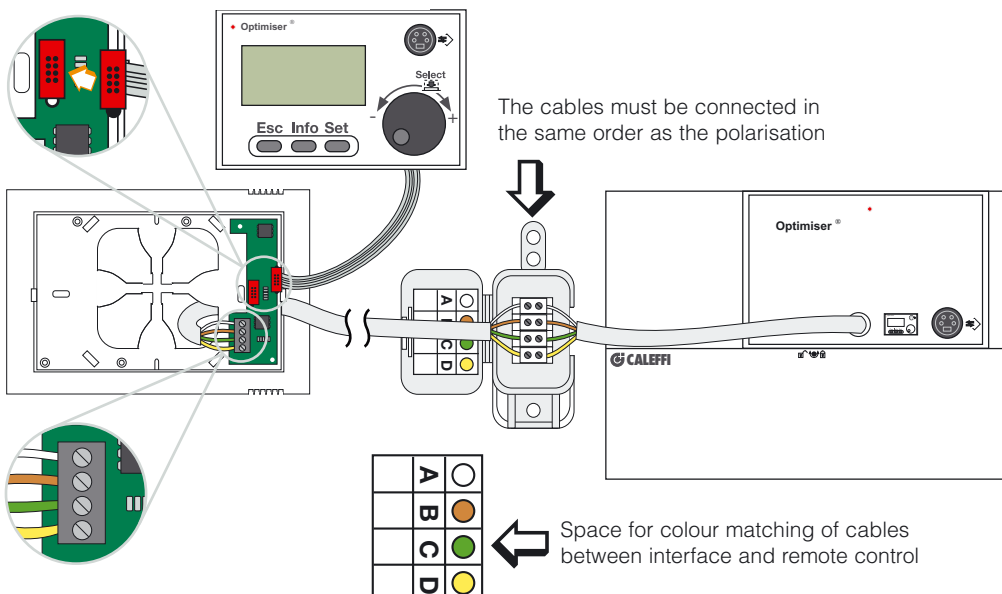

Probe connection
Dedicated raceway must be used for the connection of the flow, return and outside probes, the room probe thermostat and controller.
If the connection cable shares the raceway with other power cables, shielded and earthed cable must be used.
Any alteration to the wiring of the controller could result in electrical disturbance.
A reset must be done (i.e. switching the controller's power supply off for a few seconds) whenever work is done on the wiring.
Maximum distance between remote control and controller: 100 m, with 4-pole cable of 0.5 mm² section.

Commissioning - immediate start

The controller is ready to start operating immediately using the factory configurations, for radiant panel systems.

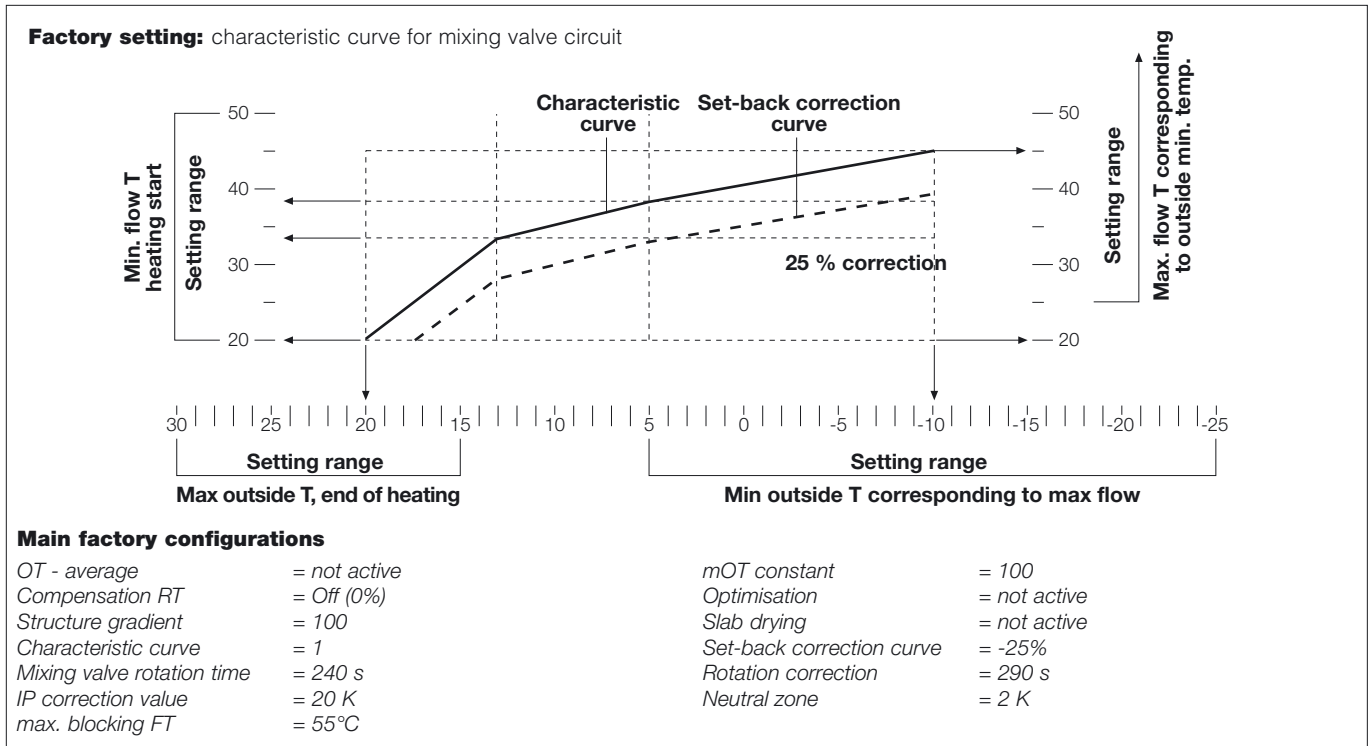

Operating information

	Meaning		Meaning		Meaning
A	Automatic	▪	Off	Λ	Mixing valve opens/ or scroll menu up
I	T max	>	Line choise	÷	Mixing valve stopped
□	Off	>>	Selected value	V	Mixing valve closes/ or scroll menu down
□	Stand by	#	Edited value	┌	Mixing valve fully open position
☀	Comfort	-Λ	Probe resistance above working range	└	Mixing valve fully closed position
)	Set-back correction	V-	Probe resistance below working range	I	Measured value
!	On	X-	Value not available	S	Calculated nominal value

Details of functions

Adjustment of flow temperature in relation to the outside temperature

The calculated flow temperature depends on the quantities read by the probes: outside, flow, return probe, room probe thermostat and set curve.

Mixing valve and pump blocking safety system

Long shutdown periods, such as in the summer, could lead to mixing valve malfunctions or pump blocking.

To avoid this, the mixing valve and pump are operated automatically for 60 seconds every day.

Frost protection function - double control level

First level: the pump is switched on if the outside temperature is less than 4°C or the room temperature less than 5°C (room probe present).

It is switched off when the outside temperature exceeds 6°C or the room temperature exceeds 7°C.

Second level: if the flow or return temperature is less than 7°C, the mixing valve is opened and the pump switched on.

When this temperature in the circuit is over 20°C, the pump switches off and the mixing valve is closed.

Probe control

Outside temperature probe error

When the measured temperature range is less than -25°C or greater than +40°C, the following state automatically comes into operation: pump off, mixing valve closed and the display will show the message < OT probe malfunction > and the red LED will flash. The frost protection function, flow sensor and summer blocking safety system, however, remain enabled.

Flow temperature probe error

When the measured temperature range is less than 0°C or greater than 110°C, the following state automatically comes into operation: pump off, mixing valve closed.

The display will show the message < FT probe malfunction > and the red LED will flash.

Optional probe recognition

If there are no optional probes (room t. and return t.), the controller will signal their absence with -X- .

When the probes are connected, the system recognises them automatically.

As these are corrective probes, no alarm state is signalled in the event of a malfunction.

Slab drying (for floors, wall and ceiling heating systems)

The new low-temperature systems have to be heated gradually, after a period of natural drying.

The automatic initial heating-drying program can be used for this. This program must be activated in "Standby" function.

The overall duration is seven days.

In the first three days, the flow temperature will be maintained at 25°C. In the remaining four days, the flow temperature will be at the value set at the "max. blocking temperature" menu point (menu structure level 4).

At the end of this procedure, the slab drying function must be switched off, otherwise the controller repeats the operation automatically.

If there is a break in the electricity during the drying, the program will restart automatically from the point when the break occurred.

Procedure:

Level 0	Select
> Configuration	Select
> Desired mixing valve circuit	Select
> Operativity	Select
> Slab drying	<input checked="" type="checkbox"/> Set

CAUTION: when this procedure is set, check whether the max. blocking FT needs to be adjusted; the factory set is 55°C Comfort and set-back correction optimisation (manual or with self-learning)

Comfort optimisation and set-back correction (manual or with self-learning)

The room probe thermostat must be present for this operation.

The optimisation makes it possible to bring forward the activation of the change from set-back correction to comfort (**in this function the FT is set at the max. design specification**), so as to reduce to a minimum the actual time necessary to reach the desired comfort level.

This function can operate in three ways: = off; = active; **A** = self-learning.

Active:

Since the time of the bringing forward depends on a number of different system parameters (power, outside and room temperatures, heat exchange, type of structure, etc.), a structure gradient reference coefficient must be set.

Some reference values are given below.

Structure gradient reference values

- Building with low heat loss:	400
- Factory configuration:	100
- Building with very high heat loss:	50

Self-learning :

In this case the bringing forward of the activation depends on the controller. The maximum suggested self-learning period is **10 days**; before the end of the 10 days it is necessary to go from operating state **A** = self-learning to the = active operating state.

The resulting structure gradient coefficient will be entered automatically at the < constant ... > operating state menu point.

Average outside temperature

This function can be enabled when necessary. If enabled, the average outside temperature, known as OT ref., is calculated automatically and recorded every hour. It is used to determine the flow temperature value. The calculation of the average OT ref. makes it possible to attenuate the effect of sudden changes of outside temperature.

Effect of return temperature

If the return temperature probe is connected, the controller uses this value as an approximate parameter of the required actual thermal load. The controller calculates the difference between the design return temperature (with an influence between 0 and 50%. Factory configuration: 0%) and the actual measured value. This difference is used to change the flow temperature. For example, if the thermal load is less than the design value, there will be a final ΔT between flow and return that is lower than the design value. In this case the characteristic curve will be lowered. If the actual thermal load is greater, then the characteristic curve will be raised.

Effect of room probe thermostat

If a room probe thermostat (code 151000) is connected, the actual room temperature will be read. The user can set the desired "comfort" room temperature on the thermostat. In the "set-back correction" function, this value is automatically reduced by 2 K. During the "Manual forcing to Tmax" function, the effect of the room probe thermostat on the controller is not active. Depending on the temperature difference between the actual measured value and the set value, the characteristic curve is moved to the right or left.

Work states

Standby

In this state, the controller remains inactive, keeping the mixing valve closed and the pump off. The mixing valve and pump frost protection and anti-blocking function remains active.

Comfort

During the "comfort" function, the flow temperature is adjusted according to the measured outside temperature, following the set characteristic curve. This curve is automatically corrected if a room probe thermostat or a return probe are present.

Set-back correction

During the "set-back correction" function, the nominal flow temperature is lowered, by means of a parallel downward shifting of the characteristic curve. This shifting is settable with a parameter of between 0 and -50%.

Maximum temperature

This function guarantees heating to the maximum set temperature. This value, Tmax, can be set from 25°C to 90°C.

Standard indication and change of nominal value

On the display there is: day of week, date, time, curve correction, work state, room temperature or outside temperature.

Example:

Remote control



Control on controller

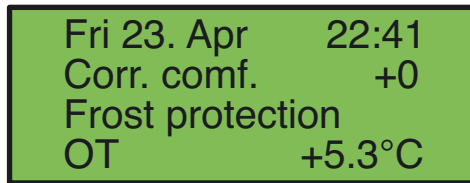

Operation with programming of time bands

10 programs are available, with a total of 13 configurable setting points (SP).

Factory configuration: program 1 (2 setting points); program 2 (5 setting points). All programs are editable.

Factory configuration program 1:
Setting points identical every day

SP point	Time	Action	Active on
1	06:00	Comfort	Mon Tues Wed Thurs Fri Sat Sun
2	22:00	Set-back correction	Mon Tues Wed Thurs Fri Sat Sun

Factory configuration, program 2:
5 setting points with different options each day.

SP point	Time	Action	Active on
1	05:00	Set-back correction	Mon Tues Wed Thurs Fri
2	07:00	Comfort	Mon Tues Wed Thurs Fri
3	09:00	Comfort	Sat Sun
4	22:00	Set-back correction	Mon Tues Wed Thurs Sun
5	23:30	Standby	Mon Tues Wed Thurs Fri Sat Sun

For a detailed description of the different functions, refer to the commissioning manual

Application diagrams

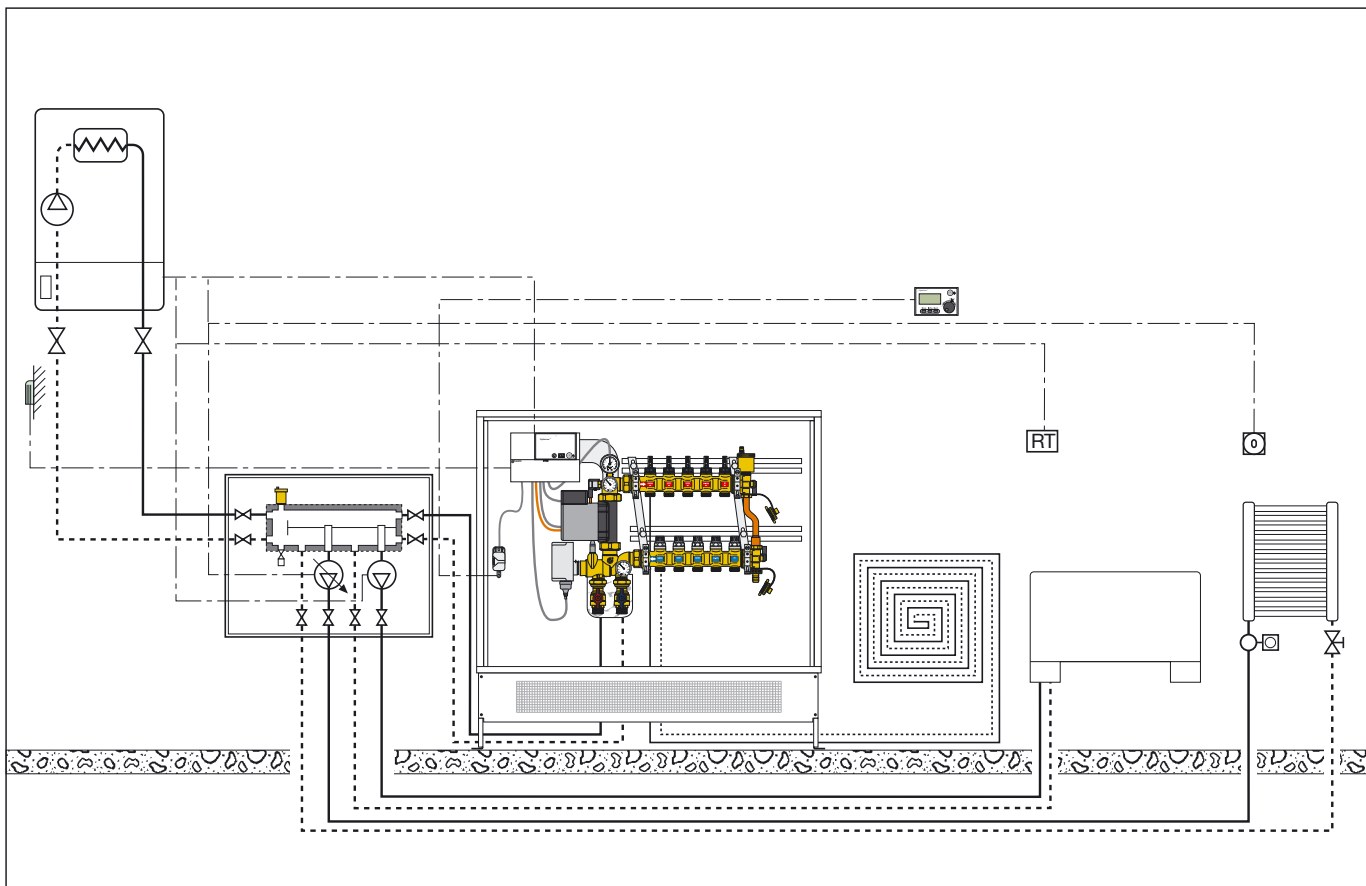
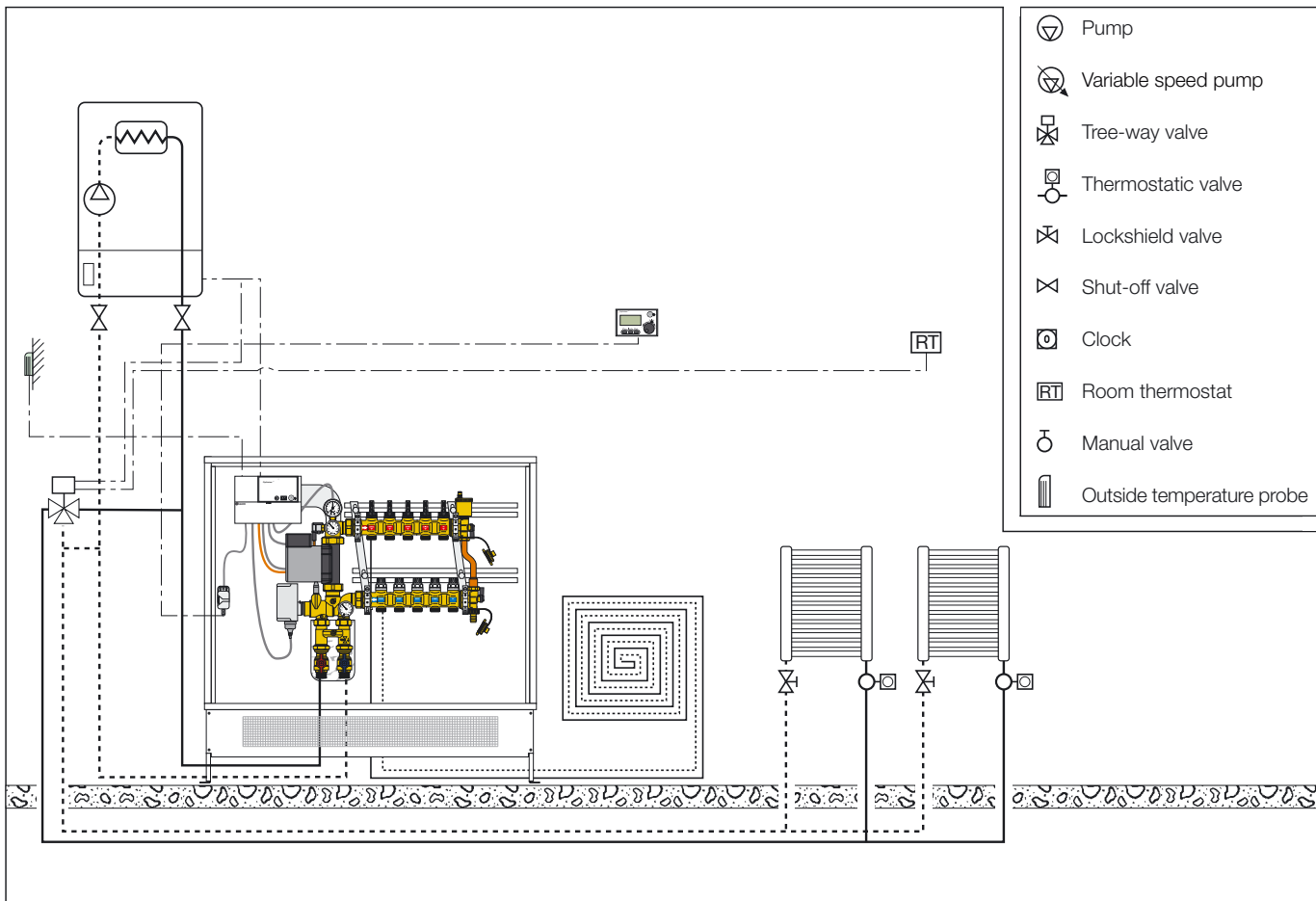

SPECIFICATION SUMMARIES

Code 1745..

Outside compensated temperature regulating unit. Connections to primary circuit 3/4" M. Connections to regulating unit 1" F with nut. Panel circuit outlet connections 3/4" M - Ø 18 mm. Medium: water and glycol solutions; maximum percentage of glycol 30%. Control temperature range 20–90°C. Primary inlet temperature range 5-100°C. Maximum working pressure 10 bar. Panel manifold differential by-pass setting 25 kPa. Primary circuit differential by-pass setting 10 kPa. Temperature gauge scale 0–80°C. Pressure gauge scale 0–10 bar. Complete with: flow manifold for panel system with 5 outlets (from 5 to 13) with brass body, flow rate regulating valve with flow meter with a scale of 1–5 l/min; return manifold for panel system with 5 outlets (from 5 to 13) with brass body, shut-off valve. Regulating unit with motorised three-way valve, three-point actuator, electric supply 230 V - 50 Hz, protection class IP 44. Digital controller, electric supply 230 V - 50 Hz, complete with probes for measuring outside, room, flow and return temperature. Management of controller and room temperature with remote control. Flow adapter unit with brass body. By-pass kit with brass body, POM differential by-pass valve and stainless steel spring. Shut-off valves with brass body and chrome plated brass ball. Safety thermostat: factory setting 55°C ± 3°C, protection class IP 55, contact rating 10 A/240 V. Three-speed circulation pump UPS 25-60 (and UPS 25-80), protection class IP 44. Pre-formed PE-X shell insulation for primary circuit. Supplied preassembled in painted steel box. Closure with a push-fit clamp. Depth adjustable from 110 to 150 mm, including floor supports adjustable in height from 270 to 410 mm.

We reserve the right to make changes and improvements to the products and related data in this publication, at any time and without prior notice



CALEFFI S.P.A. · I · 28010 FONTANETO D'AGOGNA (NO) · S.R. 229, N.25 · TEL. +39 0322 8491 R.A. · FAX +39 0322 863723

· www.caleffi.com · info@caleffi.com ·

© Copyright 2008 Caleffi