

Hydraulic separator-manifold SEPCOLL



559 series



01084/16 GB

replaces dp 01084/13 GB



Function

The SEPCOLL, a device which combines the functions of hydraulic separator and distribution manifold, is used in heating and air-conditioning systems to allow different controls of the various rooms when there is only one boiler or chiller.

The various configurations are compact and can be easily fitted in any kind of hydraulic circuit, with the advantages of ease of installation and a saving of useful living space.

SEPCOLL devices, depending on the model, are supplied complete with pre-formed shell insulation to ensure perfect Thermal insulation when used in heating only systems or heating and air-conditioning systems.

Product range

Code 559022	Hydraulic separator-manifold 2+2 with insulation and fixing brackets**	size 1 1/4"; outlets 1" (centre distance 90 mm)
Code 559031	Hydraulic separator-manifold 3+1 with insulation and fixing brackets**	size 1 1/4"; outlets 1" (centre distance 90 mm)
Code 559021	Hydraulic separator-manifold 2+1 with insulation**	size 1"; outlets 1" (centre distance 90 mm)
Code 559121	Hydraulic separator-manifold 2+1 with insulation. Complete with box**	size 1"; outlets 1" (centre distance 90 mm)
Code 559222	Hydraulic separator-manifold 2+2 with insulation and fixing brackets*	size 1 1/4"; outlets 1 1/2" (centre distance 125 mm)
Code 559231	Hydraulic separator-manifold 3+1 with insulation and fixing brackets*	size 1 1/4"; outlets 1 1/2" (centre distance 125 mm)
Code 559221	Hydraulic separator-manifold 2+1 with insulation and fixing brackets*	size 1"; outlets 1" and 1 1/2" (centre distance 125 mm)
Code 559220	Hydraulic separator-manifold 2 with insulation and fixing brackets*	size 1"; outlets 1 1/2" (centre distance 125 mm)
Code 559320	Hydraulic separator-manifold 2 with insulation and fixing brackets**	size 1"; outlets 1 1/2" (centre distance 125 mm)
Code 559331	Hydraulic separator-manifold 3+1 with insulation and fixing brackets**	size 1 1/4"; outlets 1 1/2" (centre distance 125 mm)

* For heating systems

** For heating and air-conditioning systems

Technical specifications

Materials:

Body: painted steel
 Maximum working pressure: 6 bar
 Working temperature range: 0–110°C

Performance:

Medium: water; non-hazardous glycol solutions excluded from the guidelines of directive 67/548/EC

Connections: - main (centre distance 90 mm): 3+1 and 2+2: 1 1/4" F
 2+1: 1" F
 - main (centre distance 125 mm): 3+1 and 2+2: 1 1/4" F
 2+1 and 2": 1" F
 - outlets (centre distance 90 mm): 1" M
 2+1 (side): 1" F
 - outlets (centre distance 125 mm): 1 1/2" with captive nut
 2+1 (side): 1" F
 - for air vent: 1/2" F
 - for drain cock: 1/2" F

Centre distance: - main: 3+1 and 2+2: 80 mm
 2 and 2+1: 60 mm
 - outlets (559022/031/021/121): 90 mm
 - outlets (559222/231/221/220/320/331): 125 mm

Technical specifications of insulation

codes 559022 - 559031 - 559021 - 559121 - 559320 - 559331

Material: closed cell expanded PE-X
 Thickness: 20 mm
 Density: - inner part 30 Kg/m³
 - outer part 50 Kg/m³
 Thermal conductivity (DIN 52612): - at 0°C 0,038 W/(m·K)
 - at 40°C 0,045 W/(m·K)
 Coefficient of resistance to diffusion of water vapour (DIN 52615): >1.300
 Working temperature range: 0–100°C
 Reaction to fire (DIN 4102): class B2

codes 559222 - 559231 - 559221 - 559220

Material: EPP
 Thickness: 20 mm
 Thermal conductivity: - at 10°C 0,037 W/(m·K)
 Density: 45 kg/m³
 Working temperature range: -5–120°C
 Reaction to fire (UL 94): class HBF

Hydraulic characteristics

Maximum recommended flow rate at connections:

Code	Outlets	Primary	Secondary (total)
559021/121/221	2+1	2 m³/h	5 m³/h
559022/222	2+2	2,5 m³/h	6 m³/h
559031/231/331	3+1	2,5 m³/h	6 m³/h
559220/320	2	2 m³/h	5 m³/h

Dimensions

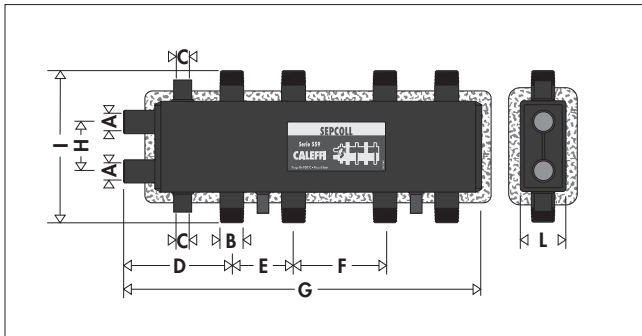

Code	A	B	C	D	E	F	G	H	I	L	Mass (kg)	Volume (l)
559022	1 1/4"	1"	1/2"	160	90	140	530	80	250	80	13,2	6,9

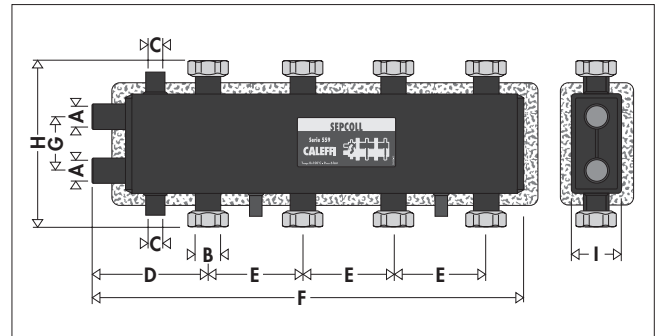

Code	A	B	C	D	E	F	G	H	I	Mass (kg)	Volume (l)
559222	1 1/4"	1 1/2"	1/2"	180	125	605	80	300	80	13,1	7,5

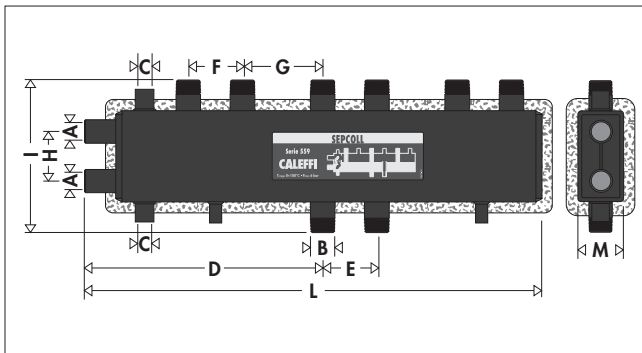

Code	A	B	C	D	E	F	G	H	I	L	M	Mass (kg)	Volume (l)
559031	1 1/4"	1"	1/2"	390	90	90	140	80	250	760	80	17,5	9,8

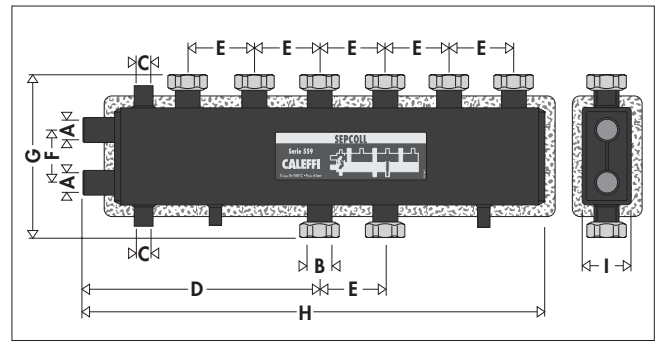

Code	A	B	C	D	E	F	G	H	I	Mass (kg)	Volume (l)
559231	1 1/4"	1 1/2"	1/2"	430	125	80	256	855	80	18,2	10,6
559331	1 1/4"	1 1/2"	1/2"	430	125	80	256	855	80	18,2	10,6

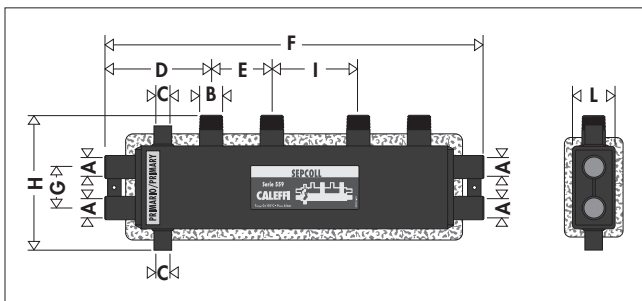

Code	A	B	C	D	E	F	G	H	I	L	Mass (kg)	Volume (l)
559021	1"	1"	1/2"	155	90	570	60	195	140	60	7,7	4,1

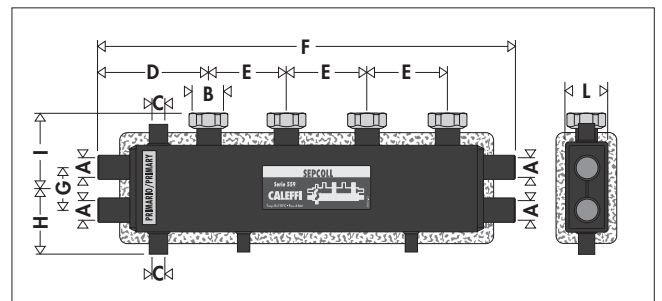

Code	A	B	C	D	E	F	G	H	I	L	Mass (kg)	Volume (l)
559221	1"	1 1/2"	1/2"	180	125	655	60	90	108	60	9,5	4,1

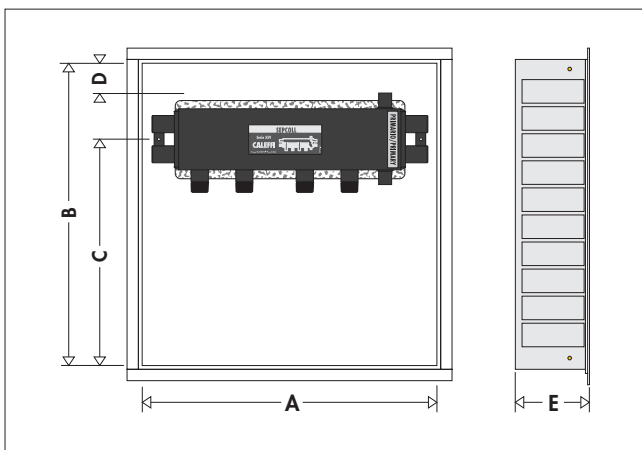

Code	A	B	C	D	E
559121	800	770	595	85	210+250

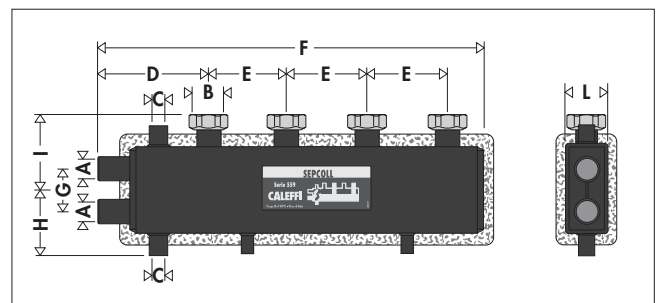

Code	A	B	C	D	E	F	G	H	I	L	Mass (kg)	Volume (l)
559220	1"	1 1/2"	1/2"	180	125	650	60	90	108	60	9,5	4,1
559320	1"	1 1/2"	1/2"	180	125	650	60	90	108	60	9,5	4,1

Operating principle

When a system has a primary production circuit with its own pump and a secondary user circuit with one or more distribution pumps, it may happen that the system operating conditions may cause the pumps to interact, creating abnormal variations in circuit flow rates and pressures.

In the SEPCOLL there is a low head loss zone, which allows to make hydraulically independent the primary and secondary circuits connected to it; **the flow in one circuit does not create a flow in the other if the head loss in the common section is negligible.**

In this case, the flow rate in the respective circuits depends only on the pump flow rate characteristics, preventing reciprocal influence caused by their connection in series.

Downstream of the hydraulic separation zone, there are the flow and return manifolds to which the various secondary distribution circuits can be connected.

Three possible hydraulic balance situations are shown below. **For more detailed information on the temperature variations caused by the separators, please consult the Caleffi Idraulica magazine nr. 18, pages 7 to 11.**

When using direct supply units and mixed regulating units connected to the same SEPCOLL, for a better temperature distribution inside the SEPCOLL, we recommend to install the direct supply units as close as possible to the hydraulic separation zone of the SEPCOLL.

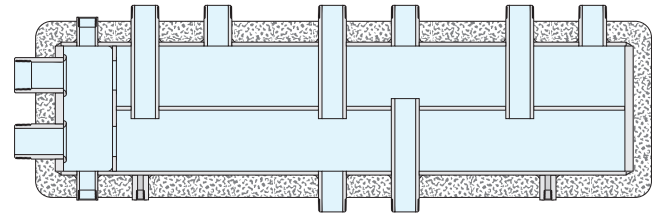
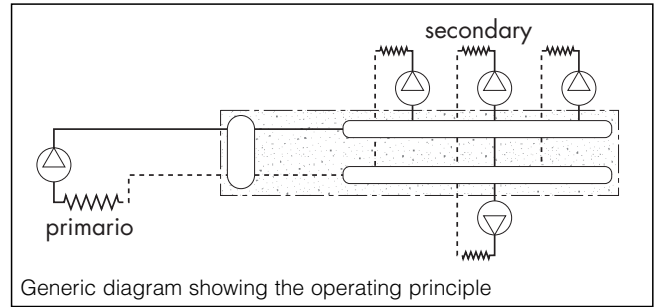

codes 559031-231-331

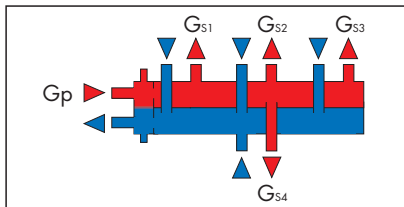

$$G_{\text{primary}} = G_{\text{secondary}} (G_{s1} + G_{s2} + G_{s3} + G_{s4})$$

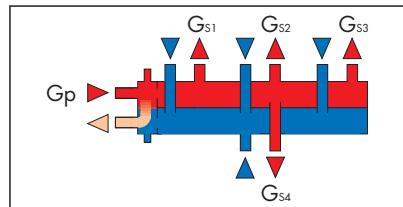

$$G_{\text{primary}} > G_{\text{secondary}} (G_{s1} + G_{s2} + G_{s3} + G_{s4})$$

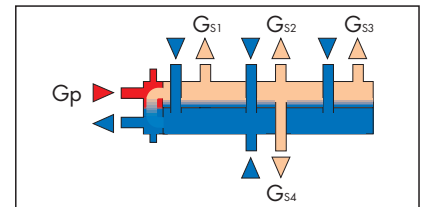

$$G_{\text{primary}} < G_{\text{secondary}} (G_{s1} + G_{s2} + G_{s3} + G_{s4})$$

Installation

SEPCOLL are composed of a hydraulic separator (primary side) and a compact monoblock manifold (secondary side), directly connected to the separator.

They can be installed in any positions, turning them upside down and/or from left to right.

SEPCOLL should be installed by respecting the connection logics as shown on the labels applied to the valve body and visible in the table "Hydraulic connections", here following.

Main rule to be followed is to avoid crossing the flow and the return lines: once chosen the upper primary connection (or lower) as boiler or chiller inlet, the secondary flow lines should start from the same manifold chamber where the primary flow enters.

As a consequence, the secondary return lines should enter in the same manifold chamber previously chosen as return to boiler or chiller.

SEPCOLL can be installed also in vertical position.

1/2" F connections should be used to connect only the air vent and drain valve, they should not be used as outlet connections. In case of installation in vertical, the air vent cannot be used.

Hydraulic connections



559022



559222



559031



559231 - 559331



559021



559221



559121



559220 - 559320

Insulation

SEPCOLL versions with codes 559022, 559031, 559021 559121, 559320 and 559331 are supplied complete with hot pre-formed shell insulation.

This system ensures not only perfect thermal insulation, but also the tightness required to prevent water vapour entering the device from the ambient. For this reason, this type of insulation may also be used in chilled water circuits as it prevents condensation from forming on the surface of the body of the device.

Codes 559222, 559231, 559221 and 559220 are supplied complete with EPP insulation. This ensures perfect thermal insulation but it can only be used for heating systems, not in chilled water circuits.

Mounting brackets

SEPCOLL versions supplied complete with fixing brackets can be wall mounted, with easy adjustment of the distance of the unit from the wall surface.

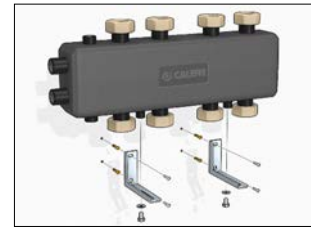
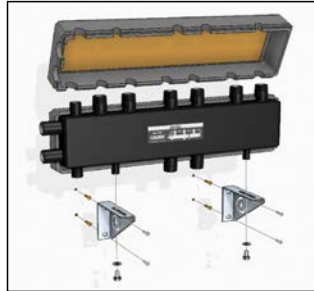

Accessories



559001

Plug with seal for not used outlets.
Size 1 1/2" M.



559002

Pair of fittings with seal. For 550 and 559 series.
Size 1 1/2" M x 1" M.

Application diagrams

System with wall-mounted boiler and SEPCOLL 2+1

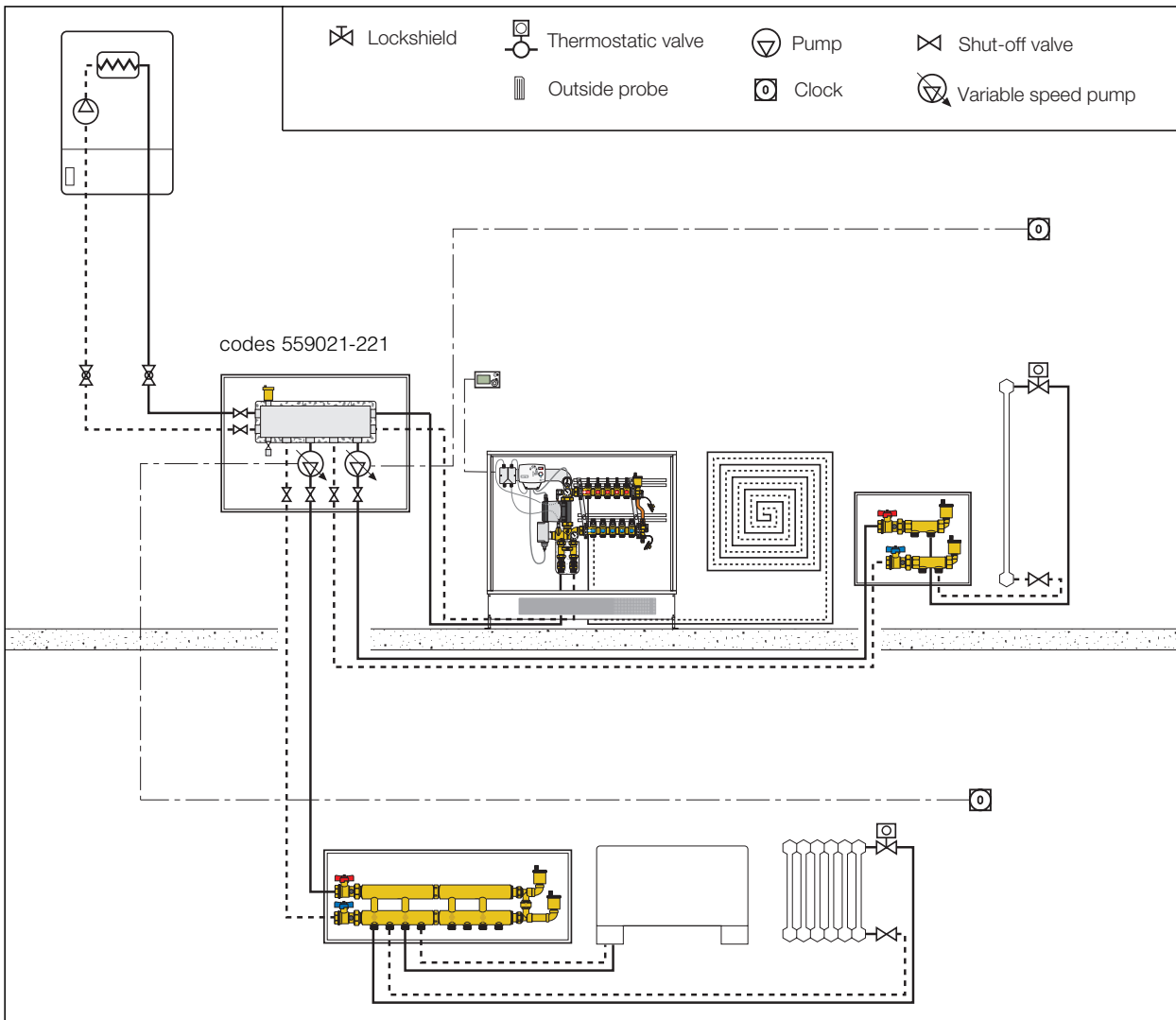

System with floor-standing boiler and SEPCOLL 3+1

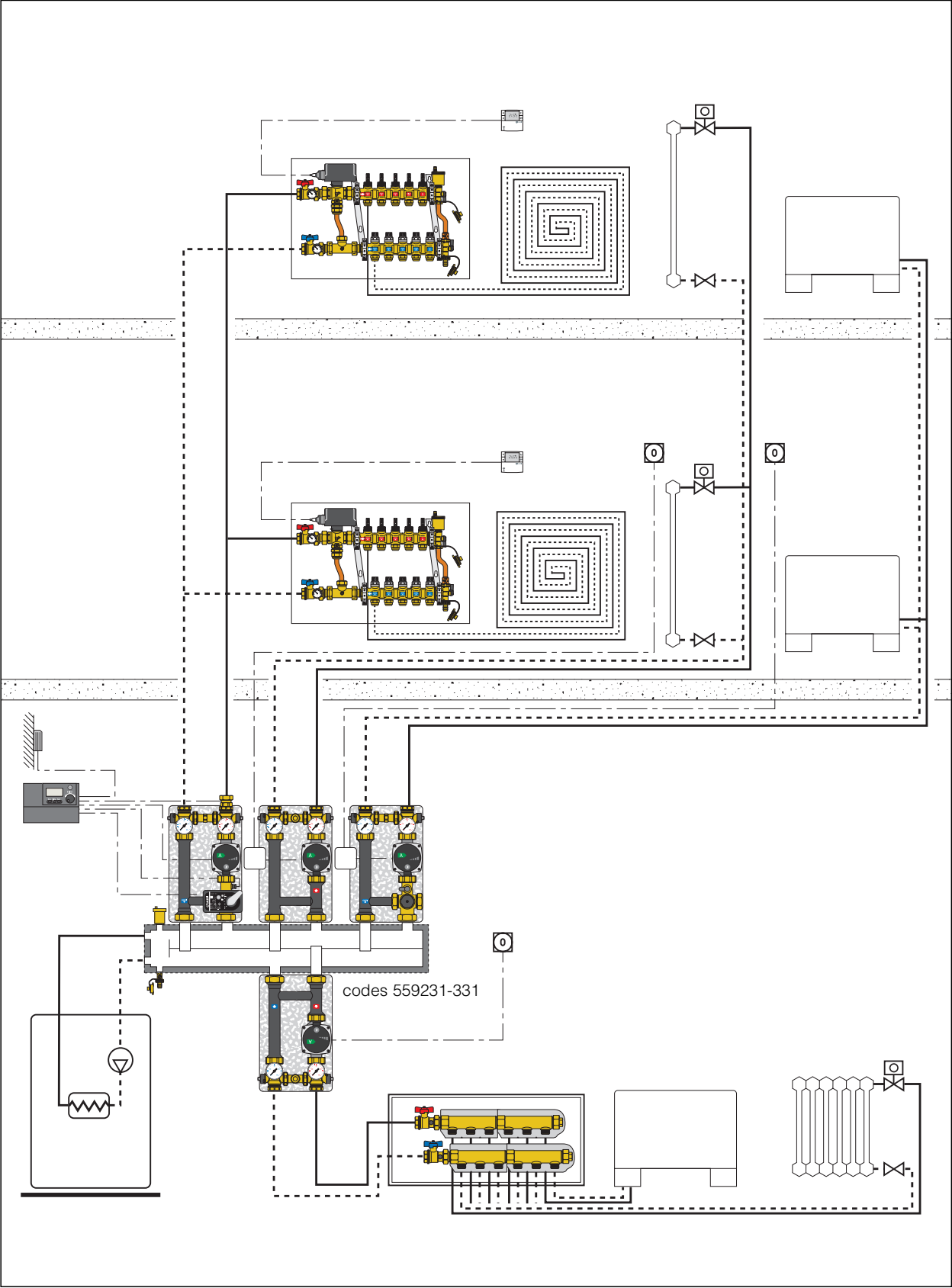

SPECIFICATION SUMMARY

Code 559022

Hydraulic separator-manifold, 2+2 outlets, for heating and air-conditioning systems. Painted steel body. Connections to generator 1 1/4" F, centre distance 80 mm. Outlet connections 1" M, two at the top and two at the bottom, centre distance 90 mm. 1/2" F connections for air vent and drain cock. Maximum working pressure 6 bar. Working temperature range 0–110°C (0–100°C with insulation). Pre-formed shell insulation in closed cell expanded PE-X. Complete with mounting brackets.

Code 559031

Hydraulic separator-manifold, 3+1 outlets, for heating and air-conditioning systems. Painted steel body. Connections to generator 1 1/4" F, centre distance 80 mm. Outlet connections 1" M, three at the top and one at the bottom, centre distance 90 mm. 1/2" F connections for air vent and drain cock. Maximum working pressure 6 bar. Working temperature range 0–110°C (0–100°C with insulation). Pre-formed shell insulation in closed cell expanded PE-X. Complete with mounting brackets.

Code 559021

Hydraulic separator-manifold, 2+1 outlets, for heating and air-conditioning systems. Painted steel body. Connections to generator 1" F, centre distance 60 mm. Outlet connections two at the bottom 1" M, centre distance 90 mm and one at the side 1" F, centre distance 60 mm. 1/2" F connections for air vent and drain cock. Maximum working pressure 6 bar. Working temperature range 0–110°C (0–100°C with insulation). Pre-formed shell insulation in closed cell expanded PE-X.

Code 559121

Hydraulic separator-manifold, 2+1 outlets, for heating and air-conditioning systems. Painted steel body. Connections to generator 1" F, centre distance 60 mm. Outlet connections two at the bottom 1" M, centre distance 90 mm and one at the side 1" F, centre distance 60 mm. 1/2" F connections for air vent and drain cock. Maximum working pressure 6 bar. Working temperature range 0–110°C (0–100°C with insulation). Pre-formed shell insulation in closed cell expanded PE-X. Complete with white painted sheet steel box. Box dimensions (h x w x d) 770 x 800 x 210–250 mm.

Code 559222

Hydraulic separator-manifold, 2+2 outlets, for heating systems. Painted steel body. Connections to generator 1 1/4" F, centre distance 80 mm. Outlet connections 1 1/2" with captive nut, two at the top and two at the bottom, centre distance 125 mm. 1/2" F connections for air vent and drain cock. Maximum working pressure 6 bar. Working temperature range 0–110°C. Pre formed shell insulation in EPP. Complete with mounting brackets.

Code 559231

Hydraulic separator-manifold, 3+1 outlets, for heating systems. Painted steel body. Connections to generator 1 1/4" F, centre distance 80 mm. Outlet connections 1 1/2" with captive nut, three at the top and one at the bottom, centre distance 125 mm. 1/2" F connections for air vent and drain cock. Maximum working pressure 6 bar. Working temperature range 0–110°C. Pre-formed shell insulation in EPP. Complete with mounting brackets.

Code 559221

Hydraulic separator-manifold for heating systems. 2+1 outlets. Painted steel body. Connections to generator 1" F, centre distance 60 mm. Outlet connections two at the top 1 1/2" with captive nut, centre distance 125 mm and one at the side 1" F, centre distance 60 mm. 1/2" F connections for air vent and drain cock. Maximum working pressure 6 bar. Working temperature range 0–110°C. Pre-formed shell insulation in EPP. Complete with mounting brackets.

Code 559220

Hydraulic separator-manifold for heating systems, 2 outlets. Painted steel body. Connections to generator 1" F, centre distance 60 mm. Outlet connections two at the top 1 1/2" with captive nut, centre distance 125 mm. 1/2" F connections for air vent and drain cock. Maximum working pressure 6 bar. Working temperature range 0–110°C. Pre-formed shell insulation in EPP. Complete with mounting brackets.

Code 559331

Hydraulic separator-manifold, 3+1 outlets, for heating and air-conditioning systems. Painted steel body. Connections to generator 1 1/4" F, centre distance 80 mm. Outlet connections three at the top and one at the bottom 1" M, centre distance 125 mm. 1/2" F connections for air vent and drain cock. Maximum working pressure 6 bar. Working temperature range 0–110°C (0–100°C with insulation). Pre-formed shell insulation in closed cell expanded PE-X. Complete with mounting brackets.

Code 559320

Hydraulic separator-manifold, 2 outlets, for heating and air-conditioning systems. Painted steel body. Connections to generator 1" F, centre distance 60 mm. Outlet connections two at the top 1" M, centre distance 125 mm. 1/2" F connections for air vent and drain cock. Maximum working pressure 6 bar. Working temperature range 0–110°C (0–100°C with insulation). Pre-formed shell insulation in closed cell expanded PE-X. Complete with mounting brackets.

Code 559001

Plug with seal for not used outlets. Size 1 1/2" M.

Code 559002

Pair of fittings with seal. For 550 and 559 series. Size 1 1/2" M x 1" M.

We reserve the right to make changes and improvements to the products and related data in this publication, at any time and without prior notice.